

GRIPPER



CATALOGUE 2020/2021

WE GENERATE EXCITEMENT.

Since the foundation of the company in 1890 until today the goal has remained the same: the highest quality in products and services. Nevertheless, the circumstances, tasks and challenges have changed, of course. By focussing on our core areas of expertise, we have long set new standards for innovative clamping technology - driven by our own development, the greatest possible flexibility and passion for individual solutions.

All this is only possible with committed and contented employees. Respectful interaction with others, personal development and measures for the wellbeing of each individual are therefore values that matter to us.



Company Management:
Wolfgang Balle, Johannes Maier (CEO), Jürgen Förster

OUR COMPANY HISTORY

- 1890 Company founded as a lock manufacturer by Andreas Maier.
- 1920 Product range extended to include spanners.
- 1928 Production line assembly of FELLBACH LOCKS.
- 1951 Introduces clamping elements and diversifies into workpiece and tool clamping technology.
- 1965 Toggle clamps extend the AMF product range, AMF catalogues are now printed in ten languages.
- 1975 Further specialisation into hydraulic clamping technology.
- 1982 Clamping and fixture systems round off AMF's clamping expertise.
- 1996 AMF team organisation in all sectors of the business, Quality management with certification to ISO 9001.
- 2001 AMF Service Guarantee for all products.
- 2004 Introduction of the ZPS zero-point clamping system.
- 2007 The magnetic clamping technology extends the AMF product range.
- 2009 Development and marketing of AMF Vacuum clamping technology.
- 2012 LOW-COST AUTOMATION gripping, clamping, marking and cleaning.
- 2014 AMF presents the most extensive product range of automation solution in zero-point clamping technology.
- 2017 Wireless sensing systems extend the expertise into Industry 4.0 and blends seamlessly into the AMF product range.

PLEDGES THAT COUNT IN EVERYDAY LIFE

For this reason, we have a few principles that we follow by conviction and which always apply..

INDIVIDUAL DEVELOPMENT

Even if the product you need does not even exist yet, we will find the right solution with you: from special designs to new developments, everything is possible.

WARRANTY

If, despite our high quality standard, there is a complaint, this is dealt with quickly and unbureaucratically, even beyond the warranty period.

HIGHEST QUALITY STANDARDS

Careful manufacturing based on tradition since 1890, and naturally with a modern quality management system according to ISO 9001 for many years.

SHORT DELIVERY TIME

With over 5,000 articles in our warehouse, you can expect your order to be dispatched on the same day.

COMPETENT SERVICE FROM EXPERTS

Your local retail partner or the specialists in our team will find the right solution for every task.

MADE IN GERMANY

Our entire product range is developed and manufactured exclusively by our employees in Germany.

THE AMF GRIPPER

4 - 5

GRIPPER, PNEUMATIC

6 - 7



GRIPPER, HYDRAULIC

8 - 9



GRIPPER INSERTS

10 - 13



GRIPPER AND WIRELESS SENSING SYSTEMS

14 - 15

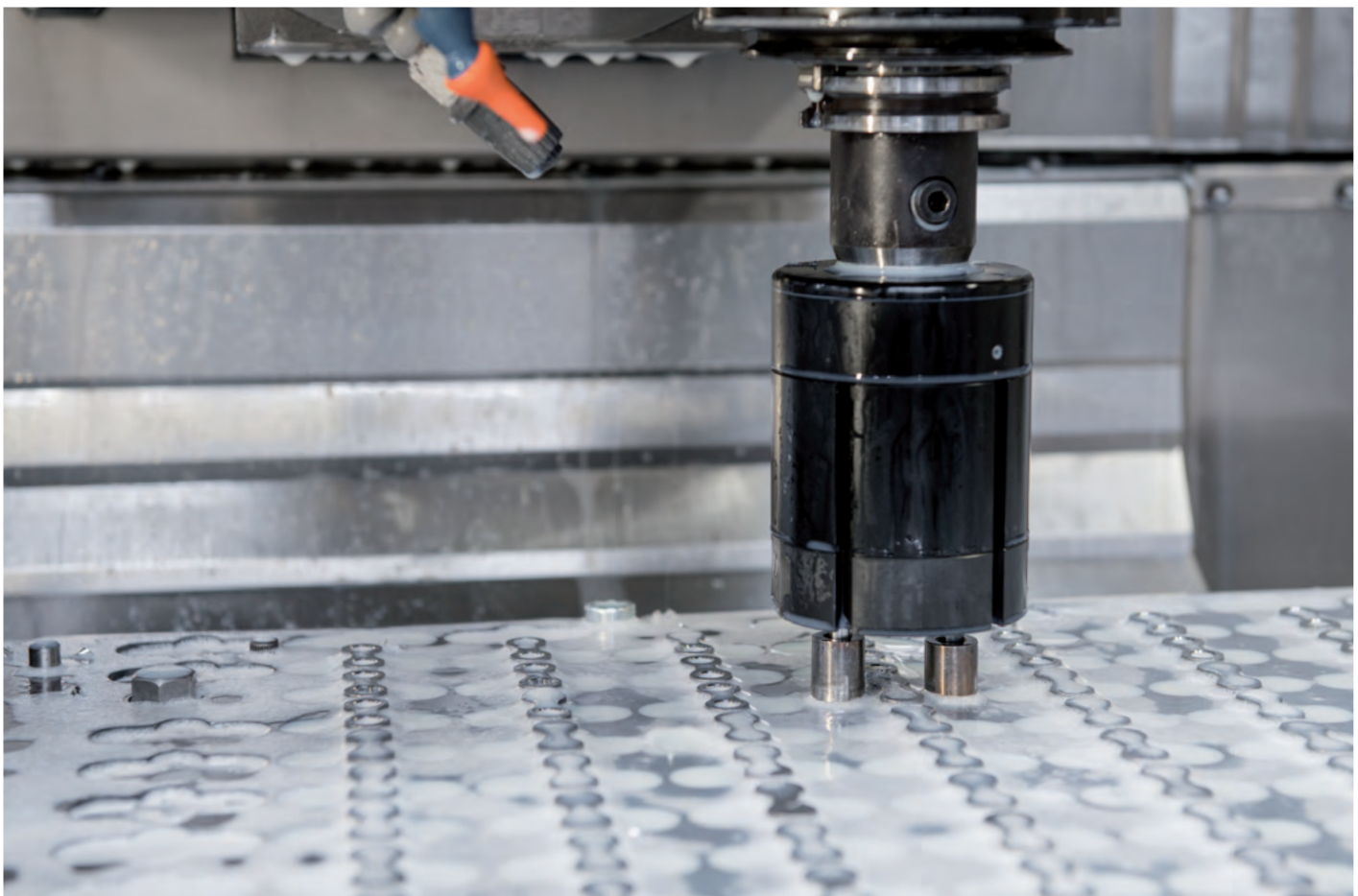

THE AMF GRIPPER AND YOUR MACHINES WILL BECOME A SURE-FIRE SUCCESS!

The modularly designed gripper system from AMF enables the automated handling of workpieces during the machining process on a machine tool.

Fully automated workpiece changes, longer machine running times and thus unmanned production shifts become possible without any high investments in a complete robot cell or large machining centres.

Shaft interface suitable for
Weldon seat and hydraulic chuck.

Simple adjustment of the
gripping force by means of a
pressure control valve

Compensation unit for optimum
protection of all components and
compensation of tolerances and
irregularities (Z: 5 mm, C: +/- 3°)

Mechanical
protection of the
gripper inserts



PNEUMATIC



HYDRAULIC

Gripper inserts can be adapted to the
workpiece size concerned by means
of displacement.

Simple adjustment of
the gripping force by
means of two throttles

THE BENEFITS AT A GLANCE:

- > It is unloaded directly from the tool magazine of the processing machine
- > The gripper is directly actuated hydraulically with cooling lubricant via the machine spindle or pneumatically by the applied compressed air as an option
- > Very high gripping forces, easily adjustable by means of a setting screw
 - up to 1000 N in the hydraulic version,
 - up to 700 N in the pneumatic version.
- > Prepared for the AMF Wireless sensing systems
- > Surfaces are burnished for steel parts and anodised for aluminium parts



CALCULATION OF THE GRIPPING FORCE

POSITIVE CONTACT WITH GRIPPER INSERT - PRISMA (ORDER NO. 538140)

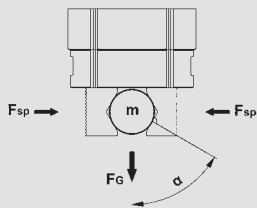

$$F_{sp} = \frac{m \times (g + a)}{2} \times \tan \alpha \times s$$

FRICTIONALLY CONNECTED WITH GRIPPER INSERT - FINGER (ORDER NO. 538165)

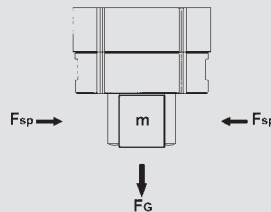

$$F_{sp} = \frac{m \times (g + a)}{2 \times \mu} \times s$$

FRICTIONALLY CONNECTED WITH GRIPPER INSERT - PRISMA/GROOVED (ORDER NO. 538140)

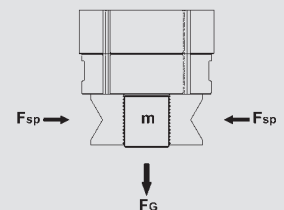

$$F_{sp} = \frac{m \times (g + a)}{2 \times \mu} \times s$$

FRICTIONALLY CONNECTED WITH GRIPPER INSERT - PRISMA (ORDER NO. 538140)

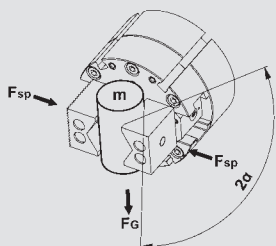

$$F_{sp} = \frac{m \times (g + a)}{2 \times \mu} \times \sin \alpha \times s$$

SIGN LEGEND

F_{sp}	Clamping/gripping force [N]
m	Workpiece mass [kg]
g	Gravity (≈ 10 m/s ²)
a	Acceleration [m/s ²] from the dynamic movement
μ	Friction coefficient between workpiece and gripper inserts
α	Draft of the gripper insert
s	Safety factor

No. 1650-210

Gripper without compensation unit, pneumatic

For part handling in the machine tool.



GERMAN DESIGN AWARD WINNER 2019



Order no.	min. operating pressure P	max. operating pressure P	Stroke [mm]	Gripping force F [N]	Weight [g]
	[bar]	[bar]			
557742	2	8	23	200-700	1720
560465	2	8	23	200-700	1720

Application:

The gripper achieves a fully automatic workpiece change during the machining process on a machine tool. It is changed from the tool magazine of the milling machine and enables workpiece handling between the part storage and the clamping device.

It is actuated by means of compressed air, which is routed through the machine spindle.

The gripper closes pneumatically and opening takes place by means of spring force.

Advantage:

- The gripping force can easily be adjusted by means of a pressure control valve and thereby adapted to the relevant requirements of the workpieces
- Easily exchangeable gripper inserts for handling various workpiece geometrics
- Easy implementation of unmanned shifts, which means greater machine utilisation and more flexibility
- Tremendous reduction of set-up times for smaller to medium-sizes batches

Note:

- Max. permitted speed: 20 [rpm]
- Suitable for Weldon seat and hydraulic expansion chucks
- Designed for ambient temperatures from 0°C to 60°C
- Transportation of workpieces up to a max. of 8 kg
- The standard supply includes three replacement seals
- Available in two designs for workpiece sizes up to a max. of 50 mm or 70 mm

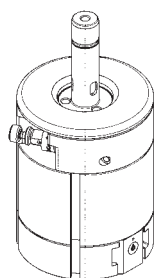
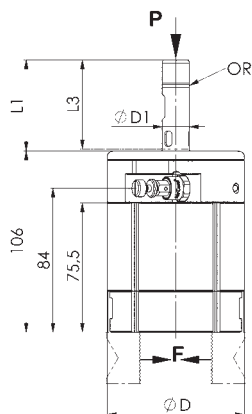
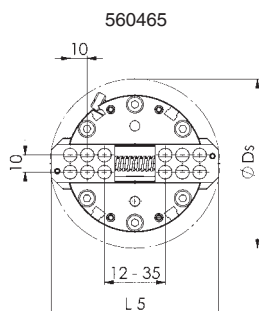
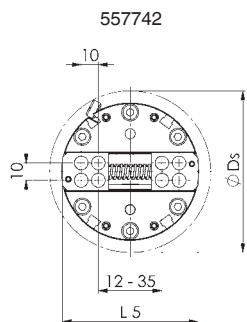

Dimensions:

Order no.	dia. D	dia. D1	Interference zone ØDs	L1	L3	Gripper extension L5
	[mm]	[mm]	[mm]	[mm]	[mm]	[mm]
557742	80	16	95,0	53	50	80
560465	80	16	97,5	53	50	100

Subject to technical alterations.

No. 1650-213

Gripper with compensation unit, pneumatic

For part handling in the machine tool.



GERMAN DESIGN AWARD WINNER 2019



Order no.	min. operating pressure P [bar]	max. operating pressure P [bar]	Stroke [mm]	Gripping force F [N]	Weight [g]
557743	2	8	23	200-700	2160
560466	2	8	23	200-700	2257

Application:

The gripper achieves a fully automatic workpiece change during the machining process on a machine tool. It is changed from the tool magazine of the milling machine and enables workpiece handling between the part storage and the clamping device.

It is actuated by means of compressed air, which is routed through the machine spindle.

The gripper closes pneumatically and opening takes place by means of spring force.

The integrated spring-loaded CX counterbalance function protects the tool, machine spindle and workpiece, and compensates for tolerances and unevenness.

Advantage:

- The counterbalance function (Z: 5 mm, C: +/- 3°) ensures that all components are optimally protected and tolerances and unevenness are compensated
- The gripping force can easily be adjusted using the pressure control valve and thereby adapted to the relevant requirements of the workpieces
- Easily exchangeable gripper inserts for handling various workpiece geometrics
- Easy implementation of unmanned shifts, which means greater machine utilisation and more flexibility
- Tremendous reduction of set-up times for smaller to medium-sizes batches

Note:

- Max. permitted speed: 20 [rpm]
- Suitable for Weldon seat and hydraulic expansion chucks
- Designed for ambient temperatures from 0°C to 60°C
- Transportation of workpieces up to a max. of 8 kg
- The standard supply includes three replacement seals
- Available in two designs for workpiece sizes up to a max. of 50 mm or 70 mm

557743

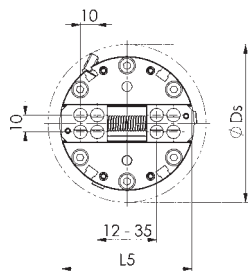

560466

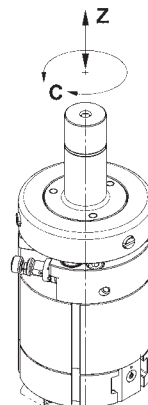
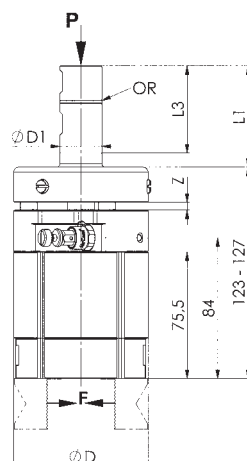
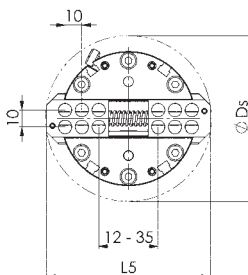

Dimensions:

Order no.	C [°]	dia. D [mm]	dia. D1 [mm]	Interference zone ØDs [mm]	L1 [mm]	L3 [mm]	Gripper extension L5 [mm]	Z [mm]
557743	+/- 3	80	25	95,0	60,5	55	80	5
560466	+/- 3	80	25	97,5	60,5	55	100	5

No. 1650-220

Gripper without compensation unit, hydraulic

For part handling in the machine tool.



GERMAN DESIGN AWARD WINNER 2019



Order no.	min. operating pressure P [bar]	max. operating pressure P [bar]	Stroke [mm]	Gripping force F [N]	Weight [g]
558639	25	30	23	250, 500, 1000	1762
558638	35	40	23	250, 500, 1000	1762
557744	45	50	23	250, 500, 1000	1762
560831	25	30	23	250, 500, 1000	1820
560829	35	40	23	250, 500, 1000	1820
560827	45	50	23	250, 500, 1000	1820

Application:

The gripper achieves a fully automatic workpiece change during the machining process on a machine tool. It is changed from the tool magazine of the milling machine and enables workpiece handling between the part storage and the clamping device.

It is actuated via cooling lubricant air, which is routed through the machine spindle. The gripper closes hydraulically and opening takes place by means of spring force.

Features:

Depending on the machine used and the operating pressure of the cooling lubricant, there are three pre-configured grippers available. Please note the minimum and maximum operating pressure.

Advantage:

- The gripping force can easily be adjusted by means of throttles and thereby adapted to the relevant requirements of the workpieces
- Easily exchangeable gripper inserts for handling various workpiece geometries
- Easy implementation of unmanned shifts, which means greater machine utilisation and more flexibility
- Tremendous reduction of set-up times for smaller to medium-sizes batches

Note:

- Max. permitted speed: 20 [rpm]
- Suitable for Weldon seat and hydraulic expansion chucks
- Designed for ambient temperatures from 0°C to 60°C
- Transportation of workpieces up to a max. of 8 kg
- The standard supply includes three replacement seals
- Available in two designs for workpiece sizes up to a max. of 50 mm or 70 mm

558639, 558638, 557744

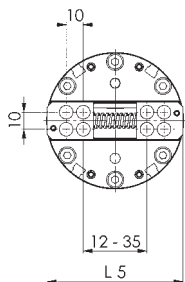

560831, 560829, 560827

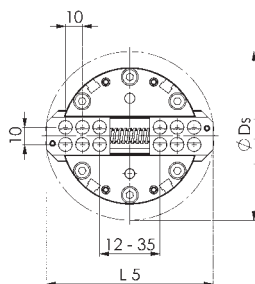

Dimensions:

Order no.	dia. D [mm]	dia. D1 [mm]	Interference zone ØDs [mm]	L1 [mm]	L3 [mm]	Gripper extension L5 [mm]
558639	80	16	80,0	53	50	80
558638	80	16	80,0	53	50	80
557744	80	16	80,0	53	50	80
560831	80	16	97,5	53	50	100
560829	80	16	97,5	53	50	100
560827	80	16	97,5	53	50	100

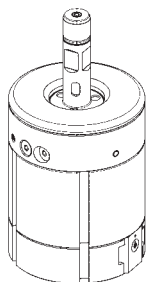
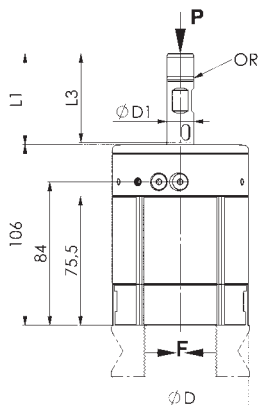

Subject to technical alterations.

No. 1650-223

Gripper with compensation unit, hydraulic

For part handling in the machine tool.



GERMAN DESIGN AWARD WINNER 2019



558641, 558640, 557745

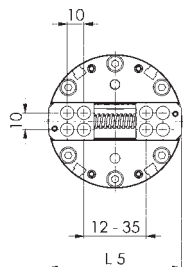

560830, 560828, 560824

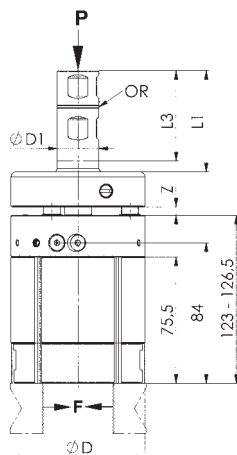
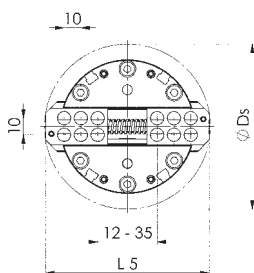

Order no.	min. operating pressure P [bar]	max. operating pressure P [bar]	Stroke [mm]	Gripping force F [N]	Weight [g]
558641	25	30	23	250, 500, 1000	2200
558640	35	40	23	250, 500, 1000	2200
557745	45	50	23	250, 500, 1000	2200
560830	25	30	23	250, 500, 1000	2288
560828	35	40	23	250, 500, 1000	2288
560824	45	50	23	250, 500, 1000	2288

Application:

The gripper achieves a fully automatic workpiece change during the machining process on a machine tool. It is changed from the tool magazine of the milling machine and enables workpiece handling between the part storage and the clamping device.

It is actuated via cooling lubricant air, which is routed through the machine spindle.

The gripper closes hydraulically and opening takes place by means of spring force.

The integrated spring-loaded CX counterbalance function protects the tool, machine spindle and workpiece, and compensates for tolerances and unevenness.

Features:

Depending on the machine used and the operating pressure of the cooling lubricant, there are three pre-configured grippers available. Please note the minimum and maximum operating pressure.

Advantage:

- The counterbalance function (Z: 5 mm, C: +/- 3°) ensures that all components are optimally protected and tolerances and unevenness are compensated
- The gripping force can easily be adjusted by means of throttles and thereby adapted to the relevant requirements of the workpieces
- Easily exchangeable gripper inserts for handling various workpiece geometrics
- Easy implementation of unmanned shifts, which means greater machine utilisation and more flexibility
- Tremendous reduction of set-up times for smaller to medium-sizes batches

Note:

- Max. permitted speed: 20 [rpm]
- Suitable for Weldon seat and hydraulic expansion chucks
- Designed for ambient temperatures from 0°C to 60°C
- Transportation of workpieces up to a max. of 8 kg
- The standard supply includes three replacement seals
- Available in two designs for workpiece sizes up to a max. of 50 mm or 70 mm

Dimensions:

Order no.	C [°]	dia. D [mm]	dia. D1 [mm]	Interference zone ØDs [mm]	L1 [mm]	L3 [mm]	Gripper extension L5 [mm]	Z [mm]
558641	+/- 3	80	25	80,0	60,5	55	80	5
558640	+/- 3	80	25	80,0	60,5	55	80	5
557745	+/- 3	80	25	80,0	60,5	55	80	5
560830	+/- 3	80	25	80,0	60,5	55	100	5
560828	+/- 3	80	25	80,0	60,5	55	100	5
560824	+/- 3	80	25	80,0	60,5	55	100	5

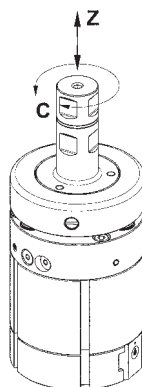

No. 1600

Gripper inserts for gripper - prism

Delivered in pairs.
 Hardened steel with wear-resistant surface.
 First side with horizontal and vertical prism, second side ribbed.

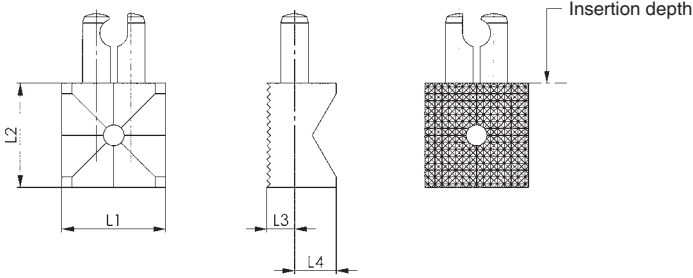

Order no.	L1 [mm]	L2 [mm]	L3 [mm]	L4 [mm]	A* [mm]	dia. D* [mm]	Weight [g]
538140	30	30	8	12	0 - 59	12,5 - 56,0	200

* Gripper with 80 mm gripper extension (L5): A=0-40 mm and $\text{ØD} = 12.5 - 39$ mm
 Gripper with 100 mm gripper extension (L5) : A=0-59 mm and $\text{ØD} = 12.5 - 56$ mm

Application:

For quick and safe parts handling in the machine tool using the AMF gripper.
 The parts are mounted to the gripper carrier and mechanically secured.

Note:

The grip inserts are suitable for all AMF grippers in the No. 1650 series.
 These can be adapted to the workpiece size concerned by displacement on the gripper carrier.

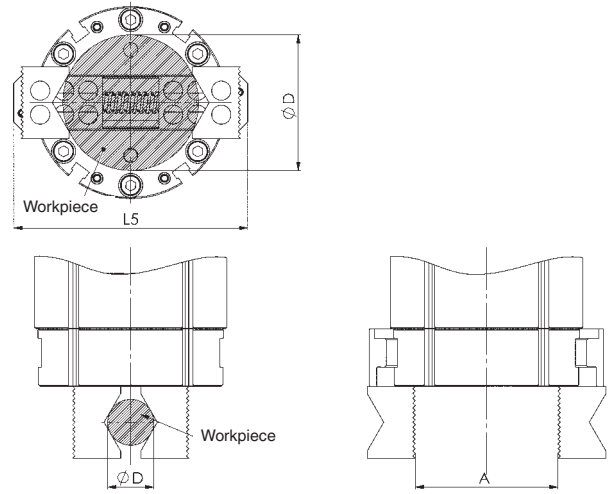

No. 1600

Gripper inserts for gripper - universal

Delivered in pairs.
 Hardened steel with wear-resistant surface.
 First side with four contact surface with ribbed surface, second side with four contact surfaces from soft plastic.

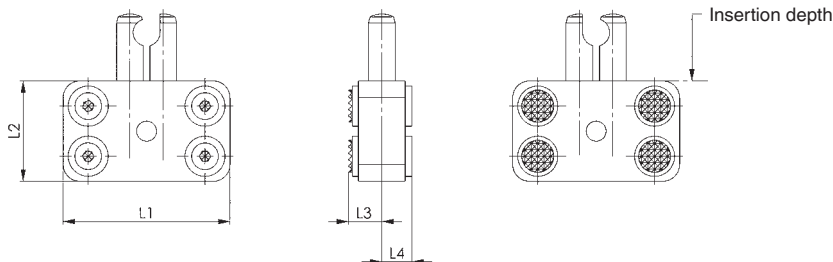

Order no.	L1 [mm]	L2 [mm]	L3 [mm]	L4 [mm]	A* [mm]	Weight [g]
538181	50	30	10	9	0 - 54	220

* Gripper with 80 mm gripper extension (L5) : A=0-34 mm
 Gripper with 100 mm gripper extension (L5) : A=0-54 mm

Application:

For quick and safe parts handling in the machine tool using the AMF gripper.
 The parts are mounted to the gripper carrier and mechanically secured.

Note:

The gripper inserts are suitable for all AMF grippers in the series No. 1650.
 They can be adapted to the workpiece size concerned by displacement on the gripper carrier.

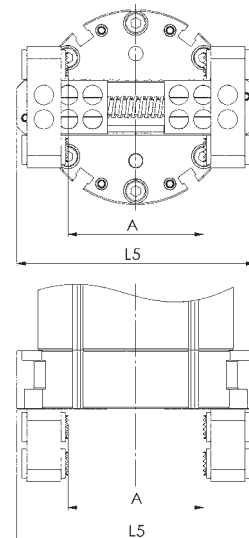

Subject to technical alterations.

No. 1600

Gripper inserts for gripper - finger

Hardened steel with wear-resistant surface.

Hardened pin with flat clamping surface on one side.

Order no.	L1 [mm]	L2 [mm]	L3 [mm]	A* [mm]	Weight [g]
538165	16	29	2,5	7,5 - 70,0	70

* Gripper with 80 mm gripper extension (L5) : A=7.5 - 50 mm

Gripper with 100 mm gripper extension (L5): A=7.5 - 70 mm

Application:

For quick and safe parts handling in the machine tool using the AMF gripper.

The parts are mounted to the gripper carrier and mechanically secured.

Note:

The gripper inserts are suitable for all AMF grippers in the series No. 1650.

They can be adapted to the workpiece size concerned by displacement on the gripper carrier.

The set includes:

- 2 x grippers - Finger left
- 2 x grippers - Finger right

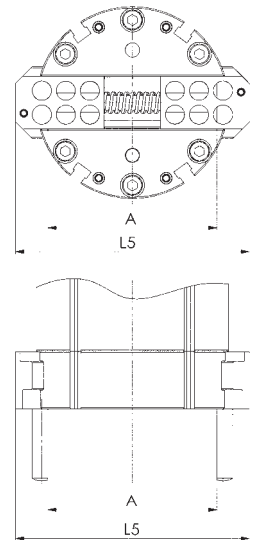
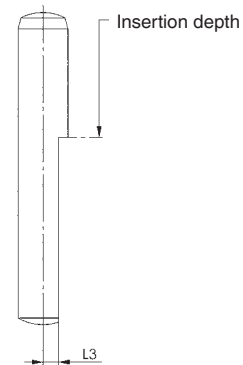
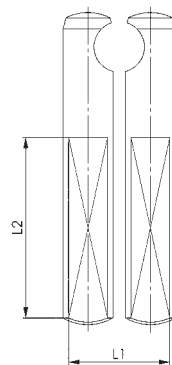

No. 1600R

Gripper inserts for gripper - blanks

for customised post-processing.

Order no.	L1 [mm]	L2 [mm]	L3 [mm]	L4 [mm]	L5 [mm]	Material	Weight [g]
561704	50	80	8	12	30	C45	950
561703	50	80	8	12	30	AW-6060	350

Application:

Aluminium or steel blanks for gripper inserts for customised post-processing.

The interface to the gripper is already integrated in the blanks.

The geometry of the blanks can be adapted to the workpiece accordingly.

Note:

The blanks for the gripper inserts are suitable for all AMF grippers in the series No. 1650.

On request:

Customized gripper inserts are available upon request.

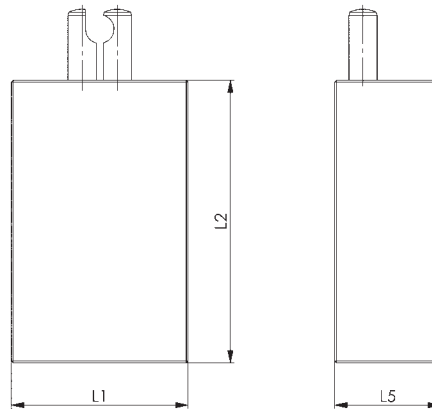

Clamping force if the length of the gripper inserts change (L2):

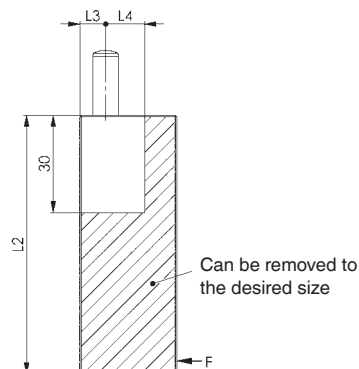
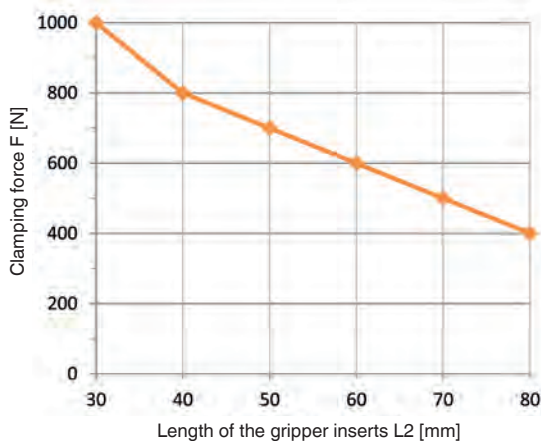



Unmanned shifts are now possible. The AMF gripper holds the workpieces between the workpiece storage and the three collets. Clamping system and storage are clamped by means of zero-point clamping system.

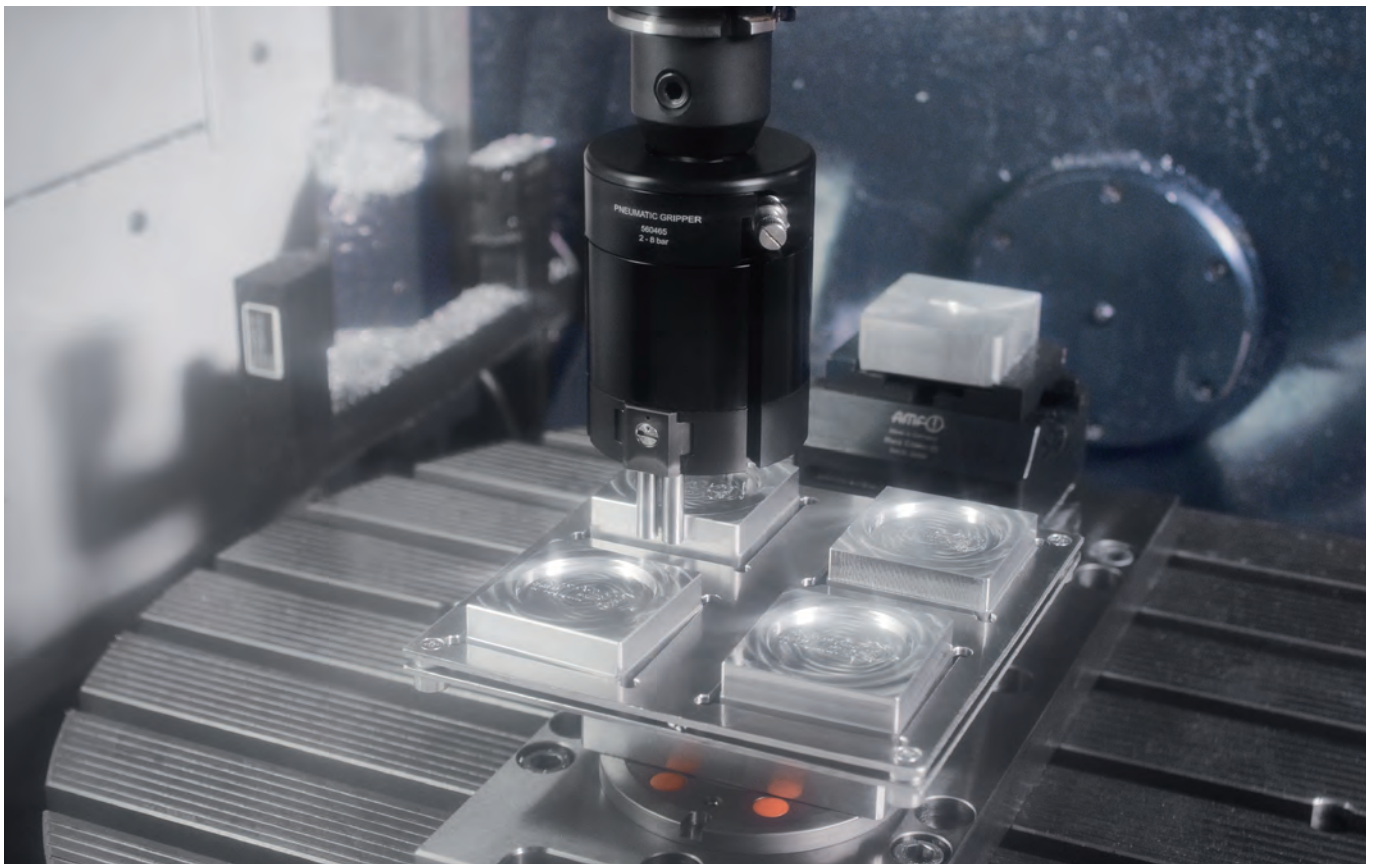

After processing, the finished workpieces are placed into the workpiece storage. This is clamped by means of the zero-point clamping system and can therefore be replaced quickly and individually.

No. 1600

Gripper inserts for gripper - wireless sensing systems

Order no.	L1 [mm]	L2 [mm]	L3 [mm]	L4 [mm]	Weight [g]
561709	30	30	12,3	12	375

Application:

The Wireless sensing systems gripper inserts are equipped with a microswitch and act as a signal transmitter (sensor), which is connected by cable to a transmitter, the Sender-Unit gripper switch (No. 5020-GM01).

The microswitch detects the presence of a gripped workpiece.

Different states of the AMF gripper can be queried with the aid of the AMF Wireless sensing systems to ensure reliable processing. The Wireless sensing systems transmit the sensor signal to a receiver (Gateway No.5010G) via Bluetooth Low Energy (BLE 4.0) by means of the Sender-Unit gripper switch.

Note:

Accessories, such as gateway, pairing stick and antenna extension, can be found in the AMF Wireless sensing systems catalogue.

The Wireless sensing systems inserts are delivered in pairs.

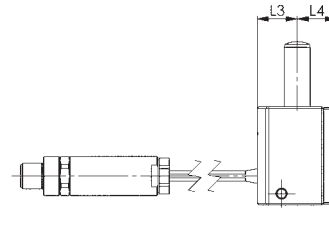
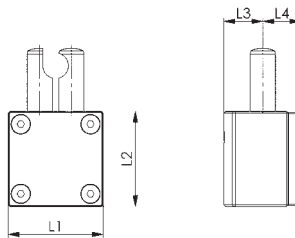

Subject to technical alterations.

No. 5010SUG
Sender-Unit Gripper

Order no.	Cabled input	Output wireless	Battery life up to [Years]	Ingress protection	Weight [g]
560408	1	1	1,5	IP67	64
560406	0	1	1,5	IP67	58

Design:

The Sender-Unit gripper is available in two versions, which vary in input for the sensor:
 - Sender-Unit gripper switch (Order no. 560408): Cabled input for an M8-round connector
 - Sender-Unit gripper reed (Order no. 560406): Sender-Unit with an integrated reed switch

Application:

The Sender-Unit gripper is the transmitter for wireless communication between the AMF gripper (No. 1650) and the gateway (receiver). A grasped workpiece can be queried via the Sender-Unit gripper switch by means of a gripper jaw with a microswitch (Order no. 561709). The bottom or top piston position of the gripper can be detected by the Sender-Unit gripper reed. The Sender-Unit is inserted into the T-slot of the gripper via a T-profile with a clamping screw and clamped.

Features:

- Output: 1 wireless to the gateway
- Transmission protocol: Bluetooth Low Energy (BLE 4.0)
- Battery life: up to 1.5 years
- Range of the radio signal: approx. 10 metres
- Designed for ambient temperatures of +5 to +65 °C

Note:

For further technical information please request the data sheet.

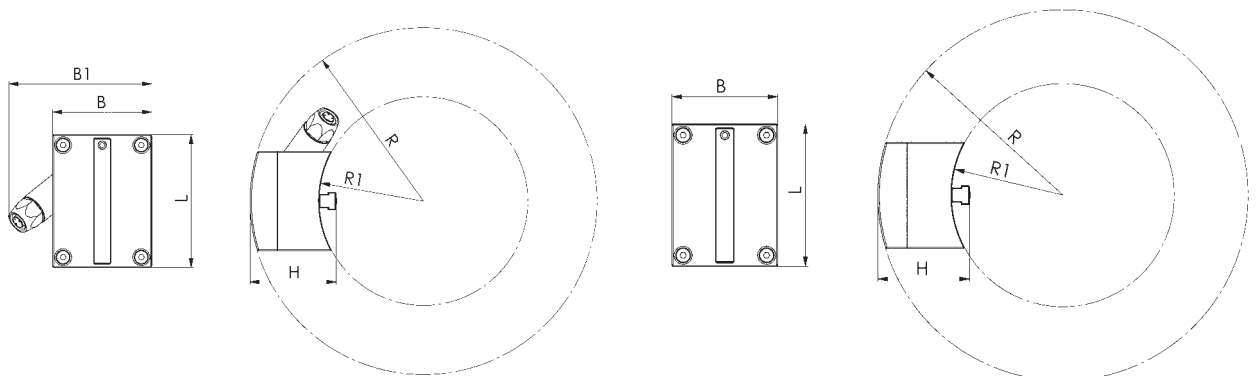

Dimensions:

Order no.	B	B1	L	H	R	R1
560408	30	54,8	51	32,9	66,5	40
560406	38	-	51	32,9	66,5	40



You can find more information in the AMF „Wireless sensing systems“ product catalogue!

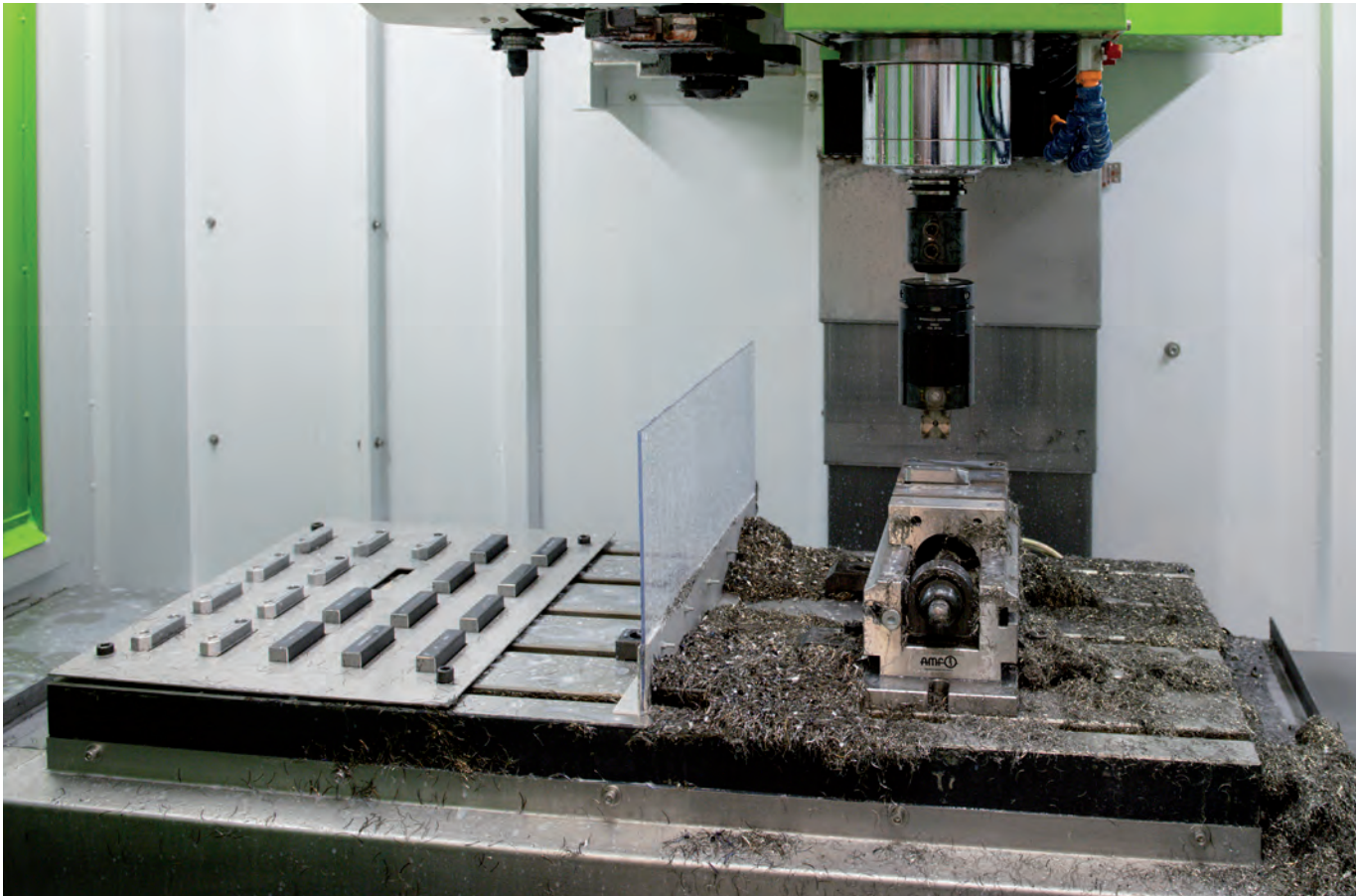

Low-cost automation, easy to implement. The AMF gripper is unloaded from the tool storage of the milling machine and transports the workpieces between the clamping system and workpiece storage before and after processing.



Subject to technical alterations.



- + Outstanding price-performance ratio
- + Drastically reduced tooling time
- + Immediate improvement of productivity
- + Repeat accuracy < 5µm
- + Stainless steel
- + Form fit



Subject to technical alterations.

These Terms of Payment apply for companies, legal entities governed by public law and public law special funds. Our goods and services are supplied exclusively on the basis of the following conditions. Any deviating purchasing conditions of the customer not expressly recognised by us will not become part of the contract through acceptance of the order. By placing the order and accepting the goods we deliver, the customer confirms its consent to our terms and conditions.

1. Offer and contractual conclusion

All our offers are always subject to change without notice unless otherwise explicitly agreed. Our delivery contracts are based on the latest version of our catalogue. Dimension and weight values, as well as illustrations, drawings and data, are non-binding and can be changed by us at any time. Therefore, deviations cannot be ruled out and do not justify any compensation claims against us.

Orders are considered accepted only when confirmed by us in writing. If, for organisational reasons, the customer does not receive a separate confirmation upon the delivery of goods, the invoice shall also be deemed the order confirmation.

2. Prices

The prices are in EURO, ex-works, excluding VAT, packing, freight, postage and insurance. Unless otherwise agreed, our list prices valid on the day of delivery shall apply. For orders below 50 EUR goods net, we must make a minimum quantity surcharge of a 10 EURO for cost reasons.

3. Tool costs

Unless any other agreements have been reached, the tools fabricated for the purpose of executing the order shall remain our property in all cases, even if we have invoiced a tool cost component separately.

4. Payment

Unless otherwise stated on the invoice, the purchase price falls due for net payment within 30 days of the invoice date (without deduction of discount). Invoice amounts of below 50 EURO are due for payment immediately.

In case of payment default, we shall be entitled to charge default interest. The amount corresponds to our interest rate for current account credits at our main bank; the minimum however being 8 percentage points above the relevant base interest rate applied by the European Central Bank. Moreover, in case of default following written notice to the customer, we shall be entitled to cease to fulfil our obligations until payments are received.

5. No set-off

The customer can set-off only with legally confirmed or undisputed counterclaims.

6. Right of withdrawal in case of delayed acceptance or payment and insolvency

If the customer fails to accept the goods in due time, we shall be entitled to set a reasonable period of grace, after which we can dispose of the goods elsewhere and supply the customer on a reasonably longer term. Our rights to withdraw from the contract under the provisions of Section 326 BGB and demand damages for non-performance shall not be affected. If the customer fails to pay for the goods once payment is due, we shall be entitled, at the end of a reasonable period of grace we have set, to withdraw from the contract and demand the return of any goods already supplied. Section 323 BGB remains unaffected in all other cases.

If the customer applies for the opening of insolvency proceedings, we shall be entitled, prior to the ordering of security measures by the insolvency court, to withdraw from the contract and demand the immediate return of the goods.

7. Customer-specific fabrications/project fabrications (custom fabrications)

Customer-specific fabrications require binding information on design, quantity etc. in written form at the time of ordering. For manufacturing reasons, we reserve the right to supply up to 10% above or below the order quantity. Technical modifications or cancellations are subject to any costs incurred. The return of customer-specific fabrications is impossible.

8. Delivery and packaging, transfer of risk

The delivery date is non-binding; although stated to the best of our knowledge. It is subject to us receiving correct, defect-free and complete deliveries. The stated delivery dates relate to completion in the factory, starting on the day the order is accepted by us. Delivery is EXW (ex-works) in accordance with Incoterms 2010. Therefore, the costs are borne by the customer. The risk is transferred to the customer when the goods are passed to the person, company or facility nominated to execute the shipment. This applies also for partial deliveries, or if we have assumed responsibility for delivery and installation. The risk shall be transferred to the customer even in the case of delayed acceptance.

In the absence of specific shipping instructions, we shall proceed as we deem fit and without any obligation to the cheapest or most expedient method. The customer agrees that the order can also be delivered in parts, insofar as this is reasonable for the customer. We shall charge a 5 EURO processing free for shipping to third parties that we supply on behalf of the customer.

The packaging complies with the packaging ordinance. Disposable packaging shall be charged at cost price. The packaging cannot be taken back.

9. Performance impediment and/or impossibility

If we are hindered in the fulfilment of our obligation due to the onset of unforeseeable circumstances, which we are unable to avoid despite reasonable effort in relation to the nature of the circumstances (e.g. operational interruption, delay in the delivery of important raw materials, defects in the delivery), the delivery time shall be extended by a reasonable period, insofar as the supply of goods or services is not rendered unreasonably difficult or impossible.

If we have to accept that these circumstances are not only temporary, we shall be entitled to withdraw from the contract either in whole or in part.

If the supply of goods or services becomes impossible, the customer shall not be obliged to furnish its own contractual service. Section 275 BGB applies mutatis mutandis. If, however, the customer is solely or predominantly responsible for the

circumstances that led to impossibility, it shall remain under an obligation to render the return service. The same applies if this circumstance occurs at a time when the customer is behind schedule with acceptance.

10. Samples/returns

Samples shall be provided only against payment. If samples or models are provided, a credit note shall be issued with the subsequent order if the order value is 125 EURO net or more. Goods can be returned only by agreement, although custom fabrications are excluded from such return.

In the case of returns for which we are not responsible (e.g. incorrect order), we shall charge a processing fee of 10%, the minimum value, however, being 7.50 EURO.

11. Retention of title

The goods shall remain our property unless full payment of all claims and/or until the cheques provided for this purpose are honoured. The itemisation of claims in an ongoing invoice, as well as balancing the account and the recognition thereof does not affect the retention of title. The customer is entitled to sell on the retained goods during the ordinary course of business. However, the customer is not permitted to pledge the goods or transfer them by way of security. It shall assign its claim ensuing from the selling on of the retained goods to us in advance. The customer shall be entitled to collect the claim to the extent that it has fulfilled its obligations towards us. At our request, the customer shall be obliged to state third-party debtors and we shall be entitled to report this and the assignment.

12. Property rights

We reserve property rights and copyrights to all contractual documents such as drafts, drawings, calculations and cost estimates. Such documents must not be reproduced or disclosed to third parties without our consent. Any rights to patents, utility models etc. reside solely with us, insofar as such patents have not yet been filed. Our products are allowed to be replicated only with our written consent.

If objects are fabricated according to drawings or samples, the customer shall warrant that any third party property rights are not infringed by manufacture or delivery. If a third party forbids manufacture and delivery on account of property rights, we shall be entitled to stop manufacture and delivery immediately. The customer shall be obliged to reimburse us with all costs incurred and indemnify us from third party compensation claims. Compensation claims by the customer are impossible.

13. Warranty

If the customer agrees with us a particular quality of the goods, we shall base this agreement on our technical delivery specifications. If we have to deliver according to customer drawings, specifications, samples etc., the customer shall assume the risk for suitability for the intended purpose. If, after the contract is concluded, the scope of goods or services is changed at the customer's request and this impairs the quality or suitability of the goods, claims for defects on the part of the customer shall be ruled out, insofar as such impairments are caused by the customer's requests for change.

The time at which the risk is transferred is decisive for the contractual state of the goods. Wear and tear of wearing parts caused by ordinary use does not constitute a defect. Claims for defects are ruled out in the following cases in particular: Unsuitable or improper use, incorrect installation and/or commissioning by the customer or third party, normal wear and tear, incorrect or negligent handling - in particular excessive use -, unsuitable equipment, replacement materials, chemical, electrochemical or electrical influences, unless such defects are caused by ourselves.

If the goods contain a defects, we shall provide, following a reasonable period of grace set by the customer, either a replacement or a repair as we deem fit. If such subsequent performance fails, the customer shall be entitled to either reduce the purchase price or withdraw from the contract. Any further warranty claims are ruled out. In case of negligible deviations from the agreed quality, no claims for defects shall be recognised.

The discovery of defects must be communicated to us immediately in writing. In the case of recognisable defects, however, within 10 days of acceptance, in the case of non-recognisable defects immediately after they become evident. The warranty is 12 months, starting with delivery of the goods ex-works.

14. Liability

With the exception of harm to life, body or health on account of a breach of duty by ourselves, our liability shall be limited to intent or gross negligence.

15. Place of fulfilment, place of jurisdiction and governing law

The place of fulfilment for all obligations ensuing from this contractual relationship is D-70734 Fellbach.

The place of jurisdiction for all legal disputes ensuing from the contractual relationship is the court responsible for the headquarters of Andreas Maier GmbH & Co. KG.

All disputes ensuing from the contract or regarding the validity thereof shall be finally decided by a court of arbitration in accordance with the Court of Arbitration Ordinance of the German Committee for Arbitration Court Procedures or the Conciliation and Arbitration Arrangement of the International Chamber of Commerce, recourse to ordinary courts of law being excluded. The legal dunning process, however, remains permissible.

German law shall govern (BGB and HGB). The applicability of the UN Convention on Contracts for the International Sale of Goods (CISG) is ruled out.

16. Severability clause

If individual provisions become legally invalid, the remaining provisions shall not be affected. The legally invalid provision shall be replaced by regulations that most closely reflect the economic purpose of the contract with reasonable consideration for the mutual interests. The publication of these Terms of Sale, Delivery and Payment renders all previous versions invalid. This does not apply for any contracts concluded prior to announcement.

GRIPPER CATALOGUE 2020/2021

Request additional catalogues from www.amf.de



ZERO-POINT-SYSTEMS



HYDRAULIC CLAMPING SYSTEMS



VACUUM CLAMPING SYSTEMS

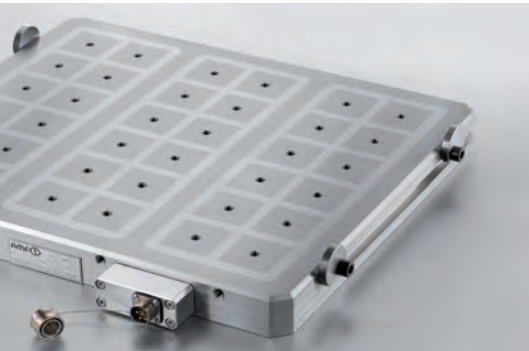

MAGNETIC CLAMPING SYSTEMS



WIRELESS SENSING SYSTEMS



TOGGLE CLAMPS



SINGLE AND MULTIPLE CLAMPING SYSTEMS



STANDARD CLAMPING SYSTEMS



MARKING AND CLEANING TOOLS



ANDREAS MAIER GmbH & Co. KG

Waiblinger Straße 116 · D-70734 Fellbach

Phone: +49 711 5766-0

Fax: +49 711 575725

E-mail: amf@amf.de

Web: www.amf.de

Order no. 562306 · € 2,40