

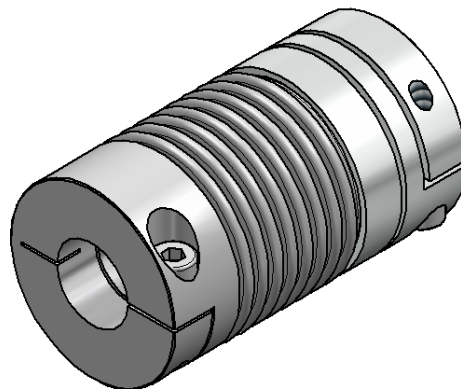

Coupling Series KB4P

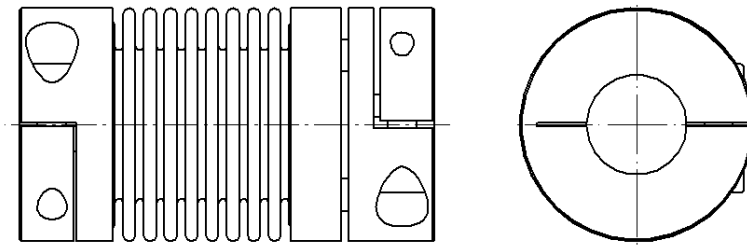

RoHS

General Information

The installation and operation instructions are an essential fact of the KBK safety coupling. It indicates tips for proper assembly, operation and maintenance. Please read these instructions carefully, and follow the instructions.

Safety Instructions

 <p>Attention!</p>	<ul style="list-style-type: none">- Installation may be performed by trained and specialized staff only.- Rotating couplings are hazard areas. The user/operator has to ensure appropriate protective measures. Do not reach into the operation area of the coupling if it is still in operation. Secure the machine against unintentional power-up during assembly work.
--	--

Manufacturer's Declaration

In accordance with directive 2006/42/EG annex IIB, shaft couplings are no machines as per the machinery directive (MR), but components for installation in machines. Operation is not permitted, unless the requirements according to the machinery directives are complied with upon integration in the final product.





Pluggable metal bellows coupling with clamping hub: KB4P

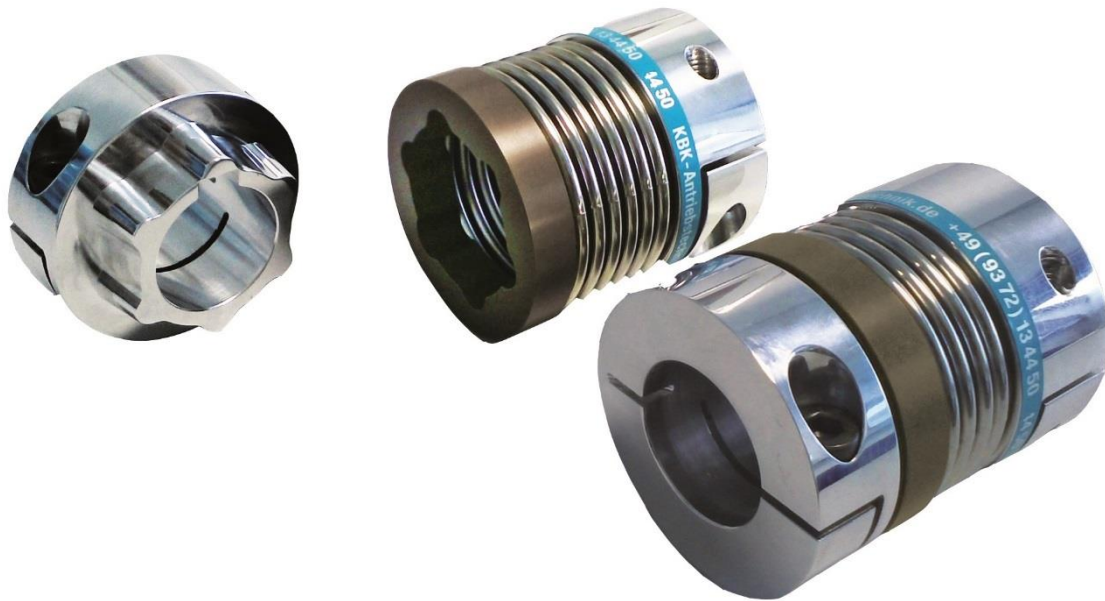

Function

KBK metal bellows couplings are flexible shaft couplings. The metal bellow compensated lateral, axial and angular shaft misalignment with low restoring forces.

Shaft-hub connections

KBK metal bellows couplings may only be used in accordance with the technical data stated in the catalogue. Retroactive processing of the coupling is not authorized.

Preparation for assembly

During assembly and disassembly, the metal bellow must not be misaligned three times higher than the permissible misalignment value stated in the catalogue. Avoid using any force. The shafts and bores of the hub must be free from dirt and burrs. Please check the connection dimensions of the shafts (as well as the dimensions regarding the key) and check the tolerances. KBK metal bellows couplings have an H7 fit. This fitting tolerance and oiling the stub shaft, facilitate both assembly and disassembly. The recommended fitting tolerance is 0,02mm-0,05mm.



Attention!

Any oils and fats containing molybdenum disulfide or any other high-pressure additives as well as lubricating pastes must not be used.



Assembly

Determine the installation dimension of the coupling prior to the assembly. This is the only way to assure that the pretension V (table 2) on the coupling is reached. For this purpose plug the coupling together, without backlash and without any axial pressure. The installation dimension is calculated from the length L minus the pretension V (installation dimension = $L - V$). Slide both hubs onto the shafts. In the correct axial position, tighten the clamping screws (A) to the torque stated in the table, by using a torque wrench. When pushing the coupling together, the pretension V of the bellow must be clearly noticeable.

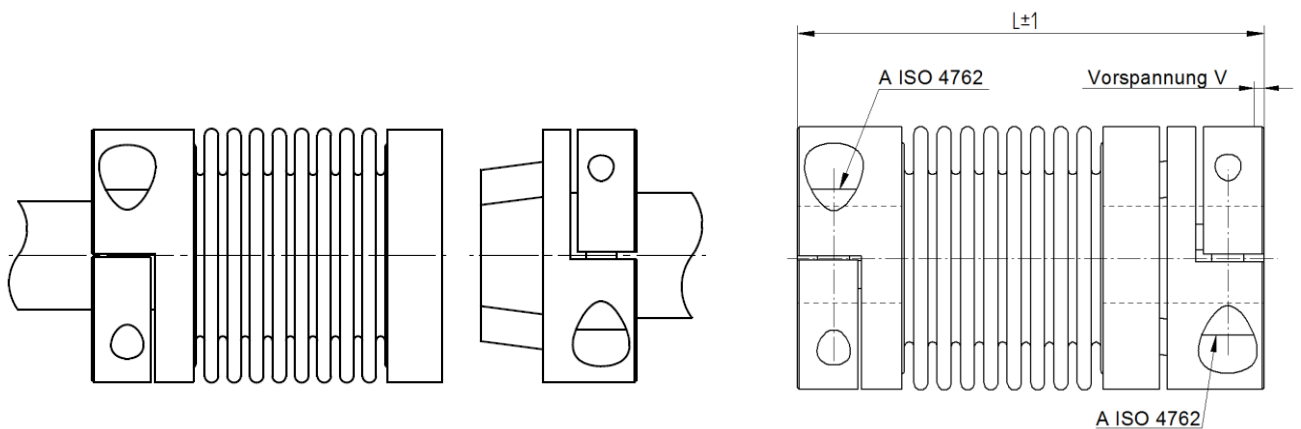

Table 1 - Torque

KB4P /	18	30	60	80	150	200	300	500
T_A (Nm) (A)	8	15	40	72	84	125	145	145

Table 2 - Pretension V

KB4P /	18	30	60	80	150	200	300	500
V (mm)	0,5-1,0	0,5-1,0	0,5-1,5	0,5-1,5	0,5-1,5	0,5-1,5	0,5-1,5	0,5-2,0

Disassembly

For disassembly, pull the KBK metal bellows coupling apart. To remove the pluggable hub, respectively the bellow body from the gear- and the motor-side loosen the clamping screws (A). Prior to re-assembly, please make sure that the hub and taper surface are free from dirt and burrs.

Maximum Misalignment

KBK metal bellows couplings compensate lateral, axial and angular shaft misalignment.

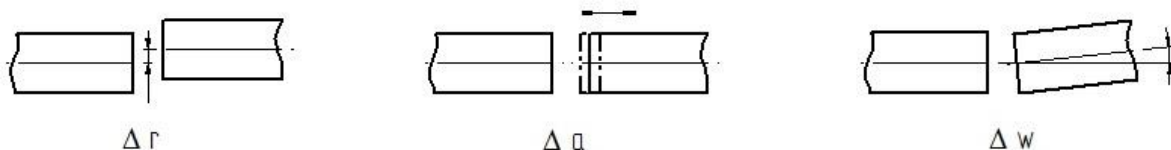



$$\sum \left[\frac{\Delta r}{\Delta r_n} * 100\% + \frac{\Delta a}{\Delta a_n} * 100\% + \frac{\Delta w}{\Delta w_n} * 100\% \right] < 100\%$$

Definition	
Δr	Radial misalignment (installed condition)
Δa	Axial misalignment (installed condition)
Δw	Angular misalignment (installed condition)
Δr_n	Maximum permissible radial misalignment (according to catalogue)
Δa_n	Maximum permissible axial misalignment (according to catalogue)
Δw_n	Maximum permissible angular misalignment (according to catalogue)



The maximum guideline value for the different misalignments can be found in our catalogue under 'technical information'. They provide security to compensate operation-related external influences e.g. thermal expansions and / or sinking foundation.

Information!



Lateral misalignment has a negative effect on the service life of the metal bellow. An exact alignment of the coupling increases the service life considerably. The load for neighboring bearings is reduced and this will have a positive effect on the running smoothness of the entire driveline.

Attention!

Maintenance

KBK metal bellows couplings are maintenance-free. Regular inspection intervals should include a visual check of the KBK metal bellows couplings. If KBK metal bellows couplings are used as intended, they will have a long-lasting durability.

Transportation

KBK metal bellows couplings are delivered ready for installation. Upon incoming goods inspection the metal bellows couplings should be stored in their original packaging and in this way they should be made available for installation. Operating and installation instructions should be always accessible for everybody at the installation location upon installation.

