

CT 200 V1

Low Profile

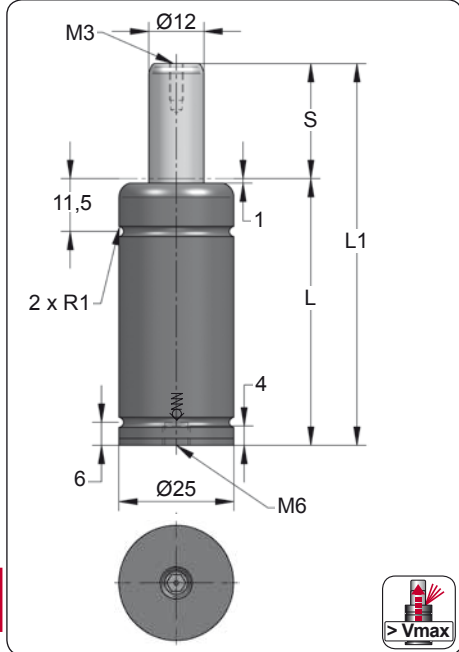

CODE	S (mm)	L1 ±0,25 (mm)	L (mm)	Kg.
CT 200 007 V1	7	47	40	0.11
CT 200 012 V1	12.7	58.4	45.7	0.29
CT 200 016 V1	16	65	49	0.13
CT 200 025 V1	25	83	58	0.35
CT 200 038 V1	38	109	71	0.41
CT 200 050 V1	50	133	83	0.46
CT 200 063 V1	63.5	160	96.5	0.52
CT 200 080 V1	80	193	113	0.60

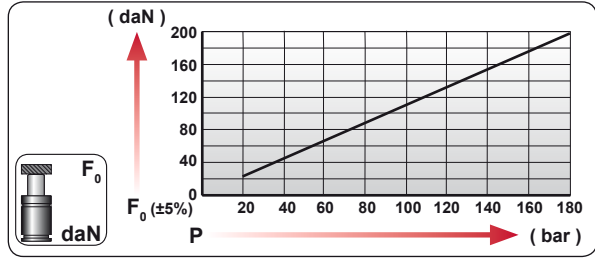

CODE	Pressure (bar)	Pressure (psi)	F ₀ (daN)	F ₁ (daN)
CT 200 050 V1	180	2610	200	295
-----	---	---	---	---

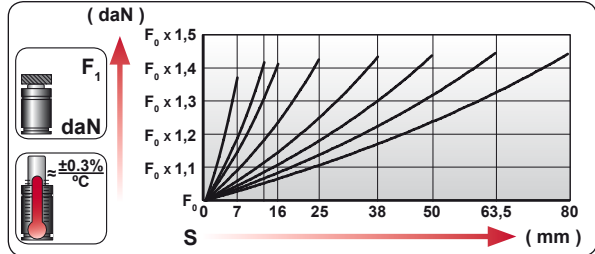

ENG ORDER
 DEU BESTELLUNG
 FRA COMMANDE
 ITA ORDINE
 ESP PEDIDO
 POR PEDIDO

F₀ daN
 S mm

CT 200 50
CT 200 050 V1

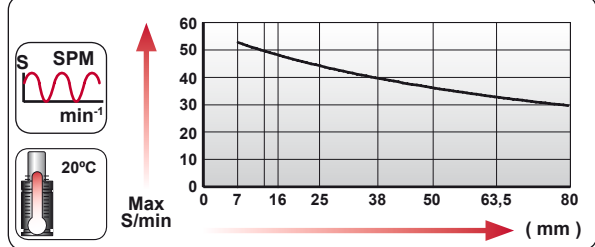

S_{max} < 100%

V

P_{min} (20°C)
 P_{max} (20°C)

T_{min}
 T_{max}

N ₂	S _{max} < 90%	V _{max} 1,6 m/s	bar psi	bar psi	°C °F	°C °F	X
			20 290	180 2610	0 32	80 176	

CT 200 V1 MOUNTS

Low Profile

A44-025

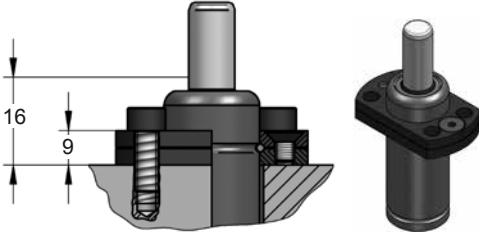
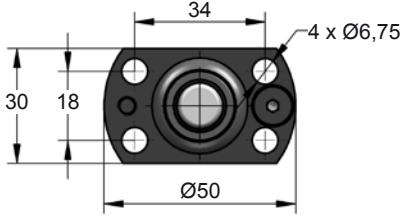

A49-025

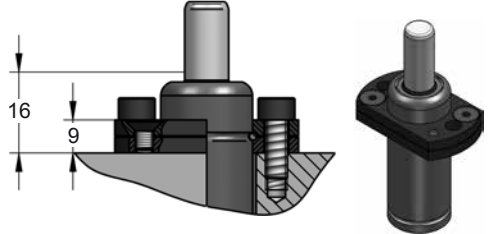
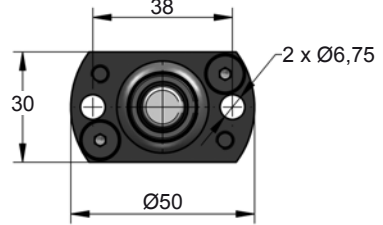

D02-025

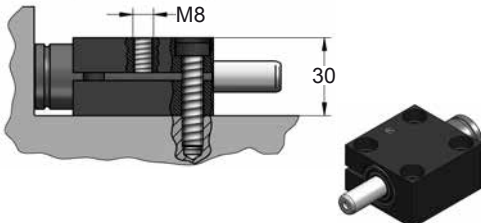
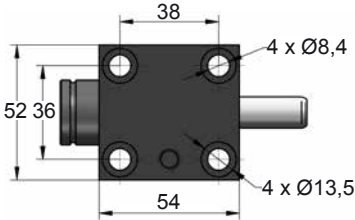

SEAL KIT S-XXXXXXX
CARTRIDGE KIT C-XXXXXXX

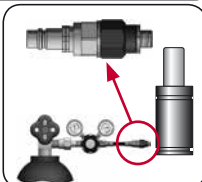
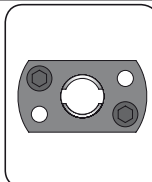

CODE	CT 200 050 V1	X	A44-025	06 CG 2-Q
ENG ORDER	GAS SPRING	REPAIR KIT	FLANGE	CHARGING ADAPTER
DEU BESTELLUNG	GASDRUCKFEDER	ERSATZTEILSATZ	FLANSCHEN	LADEADAPTER
FRA COMMANDE	RESSORT À GAZ	KIT DE RÉPARATION	BRIDE	RACCORD DE CHARGE
ITA ORDINE	CILINDRO AD AZOTO	KIT DI MANUTENZIONE	FLANGE	ADATTATORE DI CARICO
ESP PEDIDO	RESORTE DE GAS	KIT DE REPARACION	BRIDA	ADAPTADOR DE CARGA
POR PEDIDO	CILINDRO DE GÁS	KIT DE MANUTENÇÃO	FLANGE	ADAPTADOR DE CARGA