



ACCESSOIRES

ACCESSOIRES

BARRES EN "T" MODELES T250, T350, T450



Les broches à embout néoprène, les capuchons de vis et les joints également en néoprène peuvent être utilisés en conj onction avec cette barre en "T". Voir plus bas.

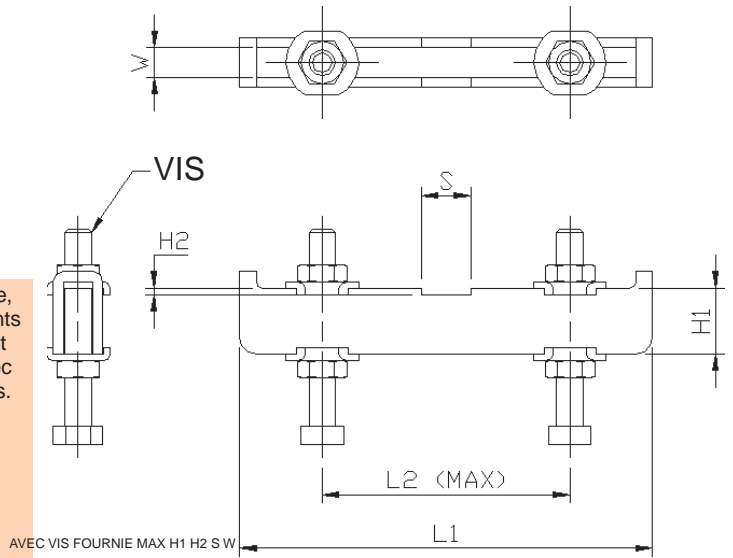

MODELE	UTILISER	AVEC VIS FOURNIE	L1	L2	H1	H2	S	W
T250	H250, V250, V300	MB0860	125	95	20	2	15	9
T350	H350, V350	MB1085	145	110	24	2	19.5	11
T450	H450, V450, H700	MB12100	200	160	25	2	23.3	13

CONSOLES POUR MONTAGE DE FACE

—Serrages verticaux et serrages horizontaux

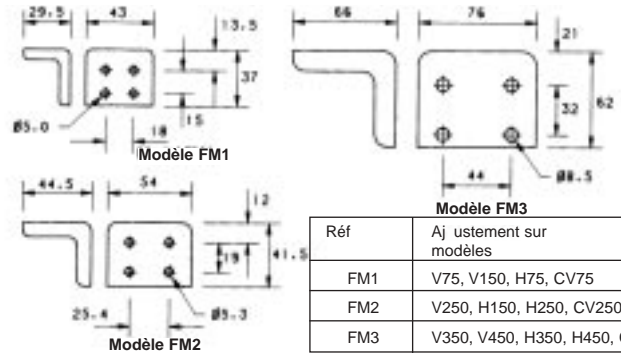

CONSOLES DE MONTAGE

—DES SERRAGES RECTILIGNES

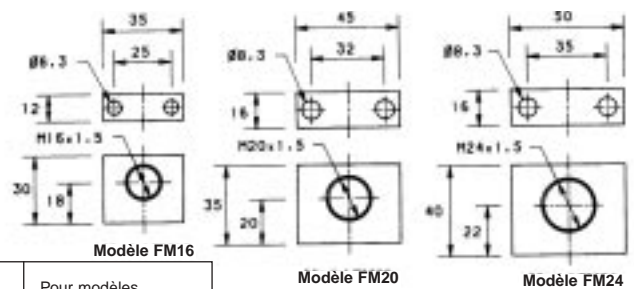

VIS

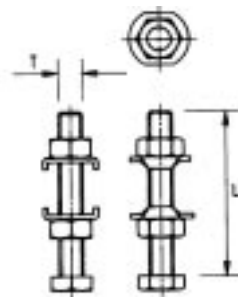

Réf	Filet. T	L	Aj ustement sur modèles
MB0420	M4	20	P50
MB0525	M5	25	H50
MB0535	M5	35	V75, H75, V100, CV75, V75X
MB0650	M6	50	V150, V200, H150, P100, P250, P350
MB0860	M8	60	V250, V300, CV250, P200, P550, P600 VP600L, P600X
MB1080	M10	80	V350, CV350, H350, P400, P450, P750 P1200, P1200L, P1200X
MB1260	M12	60	P2500, P2500L, P2500X
MB12100	M12	100	V450, VA700, VA1200, H450, H700, V450X
MB1660	M16	60	P5000, P5000L
MB16150	M16	150	V550, VA2400

ACCESSOIRES

BROCHES PLATES

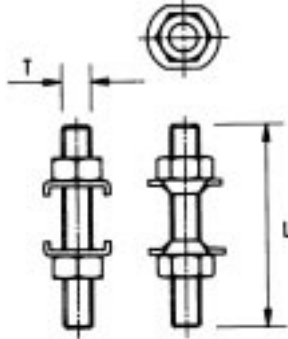

Réf	Filet. T	L	Aj ustement sur modèles
M0525	M5	25	H50
M0535	M5	35	V75, H75, V100, CV75, V75X
M0650	M6	50	V150, V200, H150, P200, P250, P350
M0865	M8	65	V250, V300, CV250, P300, P550, P600, P600L, P600X
M1085	M10	85	V350, CV350, H350, P400, P450, P750, P1200, P1200L, P1200X
M12100	M12	100	V450, VA700, VA1200, H450, H700, V450X
M16150	M16	150	V550, VA2400

BROCHES A ROTULE

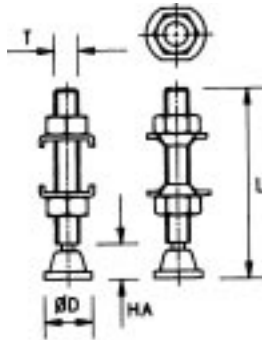

Réf	Filet. T	L	ØD	HA	Aj ustement sur modèles
MS0535	M5	35	12	10	V75, H75, V100, CV75, V75X
MS0650	M6	50	12	10	V150, V200, H150, P200, P250, P350
MS0865	M8	65	20	13	V250, V300, CV250, P300, P550, P600, P600L, P600X
MS1085	M10	85	20	15	V350, CV350, H350, P400, P450, P750, P1200, P1200L, P1200X
MS12100	M12	100	25	20	V450, VA700, VA1200, H45C, H700, V450X
MS16150	M16	150	45	30	V550, VA2400

BROCHES A EMBOUT NEOPRENE MOULE

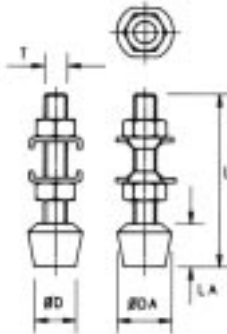

Réf	Filet. T	L	LA	ØD	ØDA	Pour serrage modèle
NTS0432	M4	32	9	8	11	P50
NTS0538	M5	38	10	10	13	H50, V75, H75, V100, CV75, V75X
NTS0645	M6	45	13	12	16	V150, V200, H150, P200, P250, P350
NTS0865	M8	63	16	16	21	V250, V300, CV250, P300, P550, P600, P600L, P600X
NTS1085	M10	86	20	22	27	V350, CV350, H350, P400, P450, P750, P1200, P1200L, P1200X
NTS12100	M12	100	24	24	30	V450, VA700, VA1200, H450, H700, V450X

CAPUCHON DE VIS NEOPRENE

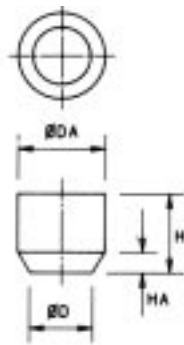

Réf	H	HA	ØD	ØDA	Pour vis modèle
NC/04	8	4	7	11	MB0420
NC/05	10	4	8	13	MB0525, MB0535
NC/06	12	4	11	15	MB0650
NC/08	15	6	13	19	MB0860
NC/10	18	7	16	23	MB1080
NC/12	20	7	19	26	MB1260, MB12100

JOINT NEOPRENE

— POUR BROCHE PLATE

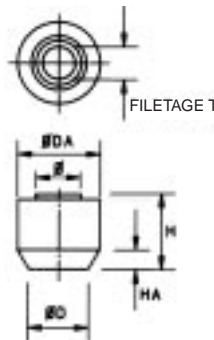

Réf	Filet. T	H	HA	ØD	ØDA	Ø	Pour broche
NP/05	-	10	1,5	-	12	-	M0525, M0535
NP/06	M6	14	4	11	15	11	M0650
NP/08	M8	18	6	13	19	15	M0865
NP/10	M10	21	7	16	23	17	M1085
NP/12	M12	23	7	19	26	21	M12100

ACCESSOIRES

PROTECTION PLASTIQUE

POUR BROCHES A ROTULES

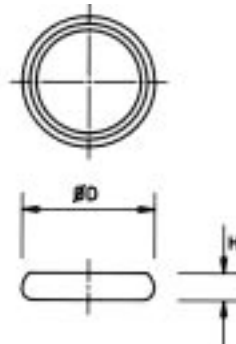

Réf	ØD	H	Pour broche
NPS/05/06	16	6	MS0535, MS0650
NPS/08/10	24	10	MS0865, MS1085
NPS/12	30	10	MS12100

RONDELLES DE PRESSION A BORD RELEVE

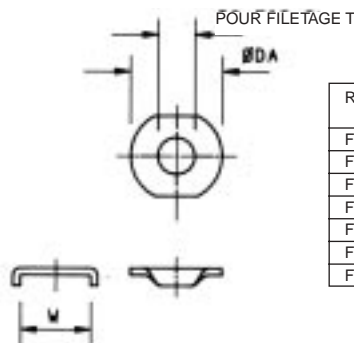

Réf	Filet. T	W	ØDA	Pour serrages avec bras type B
FW05/09	M5	9	13	H50
FW05/10	M5	10	15	H75, V75, V75X, V100
FW06/12	M6	12	18	H150, V150, V150X, V200
FW08/15	M8	15	22	H250, V250, V250X, V300
FW10/20	M10	20	26	H350, V350
FW12/23	M12	23	32	H450, V450, V450X, H700
FW16/27	M16	27	35	V550

PORTE-BROCHES

— pour broches et vis

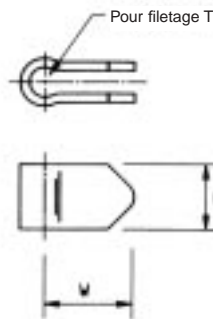

Réf	Filet T	H	W	Pour serrage avec bras type A
R/08	M8	17.5	24	V250, H250, V300
R/10	M10	22	30	V350, H350
R/12	M12	26	32	V450, H450
R/16	M16	32	35	V550

MANCHON EN PLASTIQUE

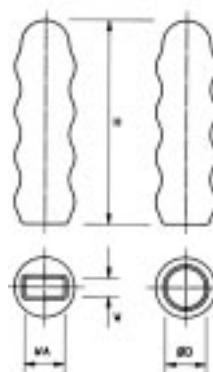

Réf	H	A monter sur les poignées diamètres			Pour serrage modèle
		W	WA	ØD	
GR/01	45	4	8		H75, V75, CV75, V100, H100
GR/02	60	5	10		H150
GR/03	40	6	10		V150, LH200
GR/04	55	5	13		H200
GR/05	58	4	13		V200, P100
GR/06	85	6	15		V250, H250, CV250, V300, LH400, P200, P350
GR/07	65	6	16		H300
GR/08	60	5	13		P250
GR/09	105	8	17		V350, CV350, H350, P400, P450, P550, TC79
GR/10	95	10	22		V450, H450, LH700
GR/11	120	10	25		V550
GR/12	105	8	19		H700
GR/13	115	8	22		P750
BR/1	70			9.5	P600L
BR/2	75			12.7	P1200L
BR/3	100			16	P2500L
B7	90			19	VA700, P5000L
B12	100			22	VA1200
B24	100			25	VA2400