

SPRĘŻYNA OKRĄGŁA FIBROFLEX® 70 SHORE A

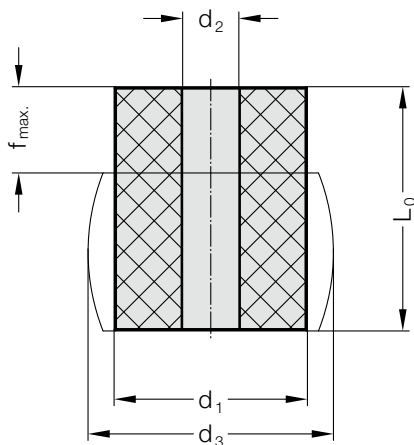

Material:

Poliuretan na bazie poliestru 70 Shore A
Kolor: biały

Uwaga:

Z powodu fizycznych właściwości elastomery poliuretanowe mają skłonność do odkształcania. Zależy ona od wewnętrznego ciepła tarcia, prędkości i liczby zmian obciążenia, ugięcia sprężyny i twardości Shore. Odkształcenie może wynosić 4 – 7% długości sprężyny L_0 .

2461.4. Sprężyna okrągła FIBROFLEX® 70 Shore A

Numer katalogowy	d_1	L_0	d_2	d_3	$f_{max.}$	Numer katalogowy	d_1	L_0	d_2	d_3	$f_{max.}$
2461.4.016.012	16	12	6,5	21	4,8	2461.4.063.100	63	100	17	81	40
2461.4.016.016	16	16	6,5	21	6,4	2461.4.063.125	63	125	17	81	50
2461.4.016.020	16	20	6,5	21	8	2461.4.080.032	80	32	21	104	12,8
2461.4.016.025	16	25	6,5	21	10	2461.4.080.040	80	40	21	104	16
2461.4.020.016	20	16	8,5	26	6,4	2461.4.080.050	80	50	21	104	20
2461.4.020.020	20	20	8,5	26	8	2461.4.080.063	80	63	21	104	25,2
2461.4.020.025	20	25	8,5	26	10	2461.4.080.080	80	80	21	104	32
2461.4.020.032	20	32	8,5	26	12,8	2461.4.080.100	80	100	21	104	40
2461.4.025.020	25	20	10,5	32	8	2461.4.080.125	80	125	21	104	50
2461.4.025.025	25	25	10,5	32	10	2461.4.100.032	100	32	21	130	12,8
2461.4.025.032	25	32	10,5	32	12,8	2461.4.100.040	100	40	21	130	16
2461.4.025.040	25	40	10,5	32	16	2461.4.100.050	100	50	21	130	20
2461.4.032.032	32	32	13,5	42	12,8	2461.4.100.063	100	63	21	130	25,2
2461.4.032.040	32	40	13,5	42	16	2461.4.100.080	100	80	21	130	32
2461.4.032.050	32	50	13,5	42	20	2461.4.100.100	100	100	21	130	40
2461.4.032.063	32	63	13,5	42	25,2	2461.4.100.125	100	125	21	130	50
2461.4.040.032	40	32	13,5	52	12,8	2461.4.125.032	125	32	27	160	12,8
2461.4.040.040	40	40	13,5	52	16	2461.4.125.040	125	40	27	160	16
2461.4.040.050	40	50	13,5	52	20	2461.4.125.050	125	50	27	160	20
2461.4.040.063	40	63	13,5	52	25,2	2461.4.125.063	125	63	27	160	25,2
2461.4.040.080	40	80	13,5	52	32	2461.4.125.080	125	80	27	160	32
2461.4.050.032	50	32	17	65	12,8	2461.4.125.100	125	100	27	160	40
2461.4.050.040	50	40	17	65	16	2461.4.125.125	125	125	27	160	50
2461.4.050.050	50	50	17	65	20	2461.4.125.160	125	160	27	160	64
2461.4.050.063	50	63	17	65	25,2						
2461.4.050.080	50	80	17	65	32						
2461.4.050.100	50	100	17	65	40						
2461.4.063.032	63	32	17	81	12,8						
2461.4.063.040	63	40	17	81	16						
2461.4.063.050	63	50	17	81	20						
2461.4.063.063	63	63	17	81	25,2						
2461.4.063.080	63	80	17	81	32						

2461.4.020.

Ø 20/70 Shore A

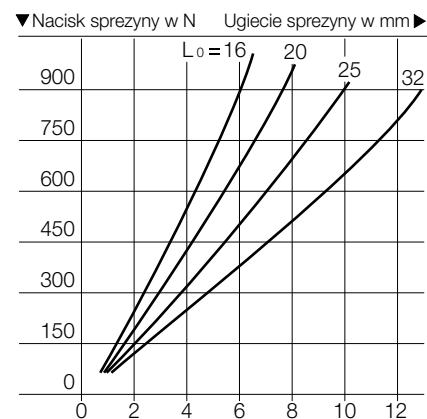



SPRĘŻYNA OKRĄGŁA FIBROFLEX® 70 SHORE A

2461.4.020.
Ø 20/70 Shore A

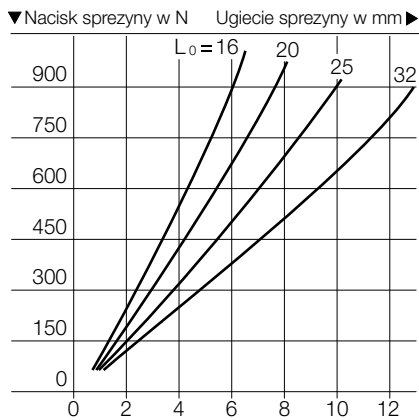

2461.4.025.
Ø 25/70 Shore A

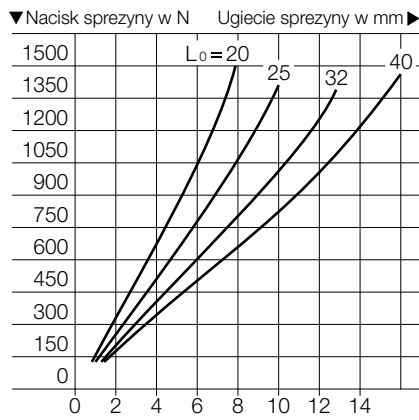

2461.4.032.
Ø 32/70 Shore A

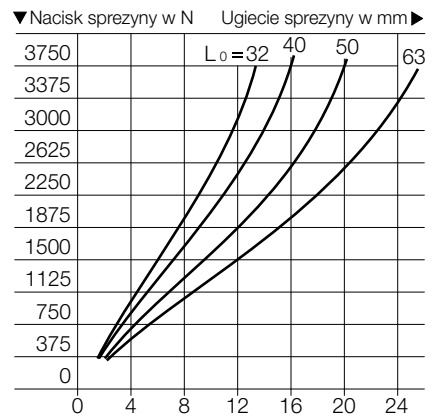

2461.4.040.
Ø 40/70 Shore A

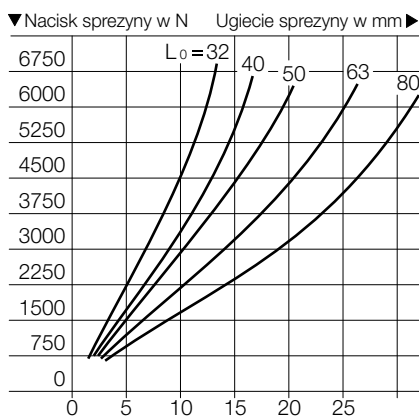

2461.4.050.
Ø 50/70 Shore A

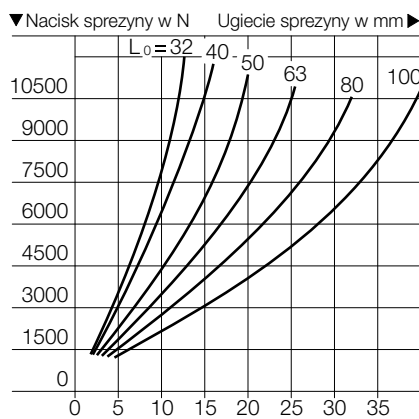

2461.4.063.
Ø 63/70 Shore A

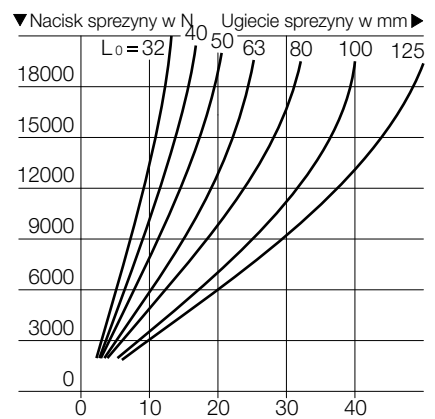

2461.4.080.
Ø 80/70 Shore A

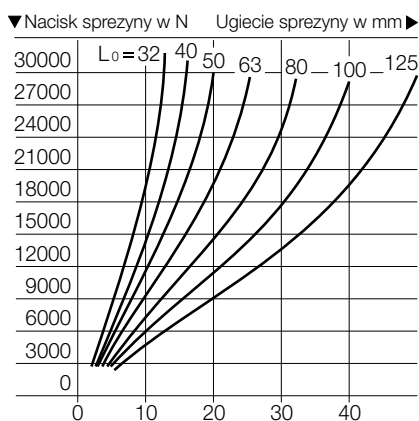

2461.4.100.
Ø 100/70 Shore A

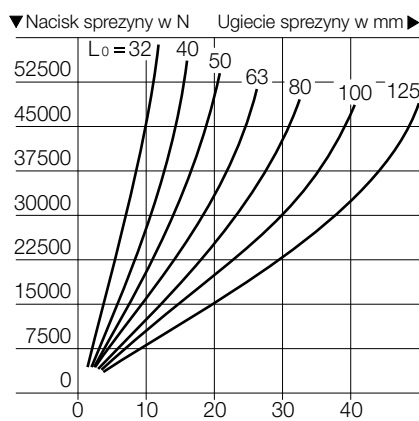

2461.4.125.
Ø 125/70 Shore A

