

# FIBROFLEX®-KRUHOVÁ PRUŽINA 80 SHORE A, DLE DIN ISO 10069-1

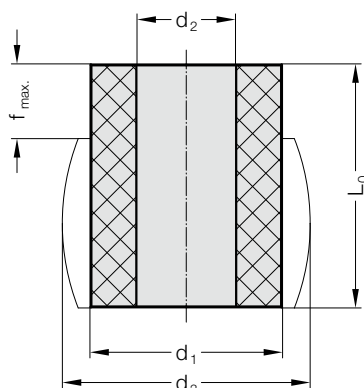

246.5.



## Popis:

Pružiny FIBROFLEX® jsou vysoce elastické polyuretanelastomerné výrobky. Tvrdost dle stupnice Shore A je důležitou vlastností pro použitý materiál FIBROFLEX®. Tuto vlastnost je nutno zohlednit při výběru správné tvrdosti pro určité případy použití.

## Materiál:

Polyuretan 80 Shore A

Barva: zelené

## Upozornění:

Na základě fyzikálních vlastností mají polyuretanové elastomery sklon k "usazení". Ten závisí na vzniklé teplotě třením, okolní teplotě, rychlosti a počtu změn zatížení, zdvihu pružiny a tvrdosti.

Může činit 4 až 7 % délky pružiny  $L_0$ .

## 246.5. FIBROFLEX®-Kruhová pružina 80 Shore A, dle DIN ISO 10069-1

Objednací číslo	$d_1$	$L_0$	$d_2$	$d_3$	$f_{max.}$	F max. [N]	Objednací číslo	$d_1$	$L_0$	$d_2$	$d_3$	$f_{max.}$	F max. [N]
246.5.016.012	16	12,5	6,5	21	4,3	1 020	246.5.063.100	63	100	17	81	35	16 200
246.5.016.016	16	16	6,5	21	5,6	980	246.5.063.125	63	125	17	81	43,7	16 000
246.5.016.020	16	20	6,5	21	7	950	246.5.080.032	80	32	21	104	11,2	31 500
246.5.016.025	16	25	6,5	21	8,7	940	246.5.080.040	80	40	21	104	14	30 100
246.5.020.016	20	16	8,5	26	5,6	1 530	246.5.080.050	80	50	21	104	17,5	29 900
246.5.020.020	20	20	8,5	26	7	1 510	246.5.080.063	80	63	21	104	22	28 800
246.5.020.025	20	25	8,5	26	8,7	1 500	246.5.080.080	80	80	21	104	28	28 300
246.5.020.032	20	32	8,5	26	10,6	1 490	246.5.080.100	80	100	21	104	35	28 100
246.5.025.020	25	20	10,5	32	7	2 600	246.5.080.125	80	125	21	104	43,7	28 000
246.5.025.025	25	25	10,5	32	8,7	2 550	246.5.100.032	100	32	21	130	10,6	56 000
246.5.025.032	25	32	10,5	32	10,6	2 520	246.5.100.040	100	40	21	130	14	52 000
246.5.025.040	25	40	10,5	32	14	2 500	246.5.100.050	100	50	21	130	17,5	50 000
246.5.032.032	32	32	13,5	42	10,6	3 900	246.5.100.063	100	63	21	130	22	47 500
246.5.032.040	32	40	13,5	42	14	3 850	246.5.100.080	100	80	21	130	28	45 000
246.5.032.050	32	50	13,5	42	17,5	3 820	246.5.100.100	100	100	21	130	35	43 300
246.5.032.063	32	63	13,5	42	22	3 800	246.5.100.125	100	125	21	130	43,7	41 500
246.5.040.032	40	32	13,5	52	10,6	6 700	246.5.125.032	125	32	27	160	10,6	92 000
246.5.040.040	40	40	13,5	52	14	6 600	246.5.125.040	125	40	27	160	14	85 000
246.5.040.050	40	50	13,5	52	17,5	6 550	246.5.125.050	125	50	27	160	17,5	80 000
246.5.040.063	40	63	13,5	52	22	6 500	246.5.125.063	125	63	27	160	22	75 000
246.5.040.080	40	80	13,5	52	28	6 480	246.5.125.080	125	80	27	160	28	71 000
246.5.050.032	50	32	17	65	10,6	10 800	246.5.125.100	125	100	27	160	35	70 500
246.5.050.040	50	40	17	65	14	10 400	246.5.125.125	125	125	27	160	43,7	70 000
246.5.050.050	50	50	17	65	17,5	10 200	246.5.125.160	125	160	27	160	56	68 000
246.5.050.063	50	63	17	65	22	10 000							
246.5.050.080	50	80	17	65	28	9 950							
246.5.050.100	50	100	17	65	35	9 900							
246.5.063.032	63	32	17	81	11,2	18 650							
246.5.063.040	63	40	17	81	14	18 000							
246.5.063.050	63	50	17	81	17,5	17 500							
246.5.063.063	63	63	17	81	22	17 000							
246.5.063.080	63	80	17	81	28	16 500							

## 246.5.016.

Ø 16/80 Shore A



▼ tah pružiny v N      průhyb pružiny v mm ▶

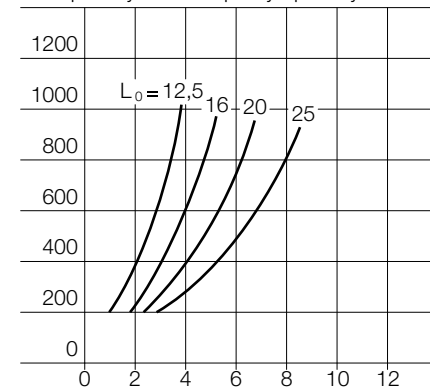



# FIBROFLEX®-KRUHOVÁ PRUŽINA 80 SHORE A, DLE DIN ISO 10069-1

246.5.020.

Ø 20/80 Shore A



▼ tah pružiny v N      průhyb pružiny v mm ▶

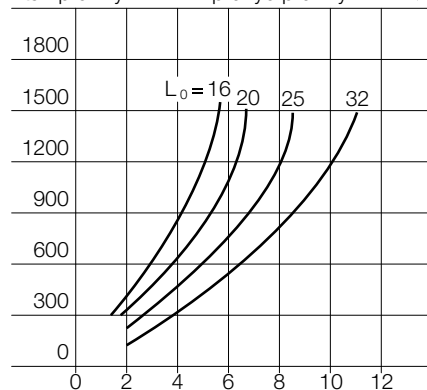

246.5.025.

Ø 25/80 Shore A



▼ tah pružiny v N      průhyb pružiny v mm ▶

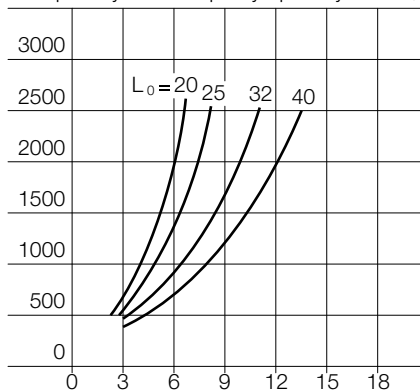

246.5.032.

Ø 32/80 Shore A



▼ tah pružiny v N      průhyb pružiny v mm ▶

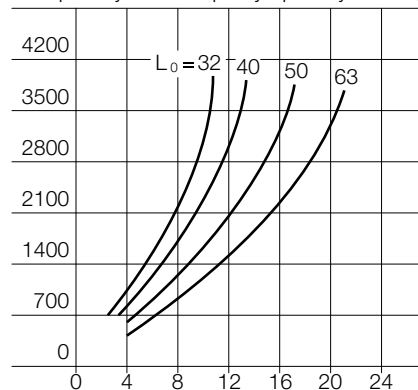

246.5.040.

Ø 40/80 Shore A



▼ tah pružiny v N      průhyb pružiny v mm ▶

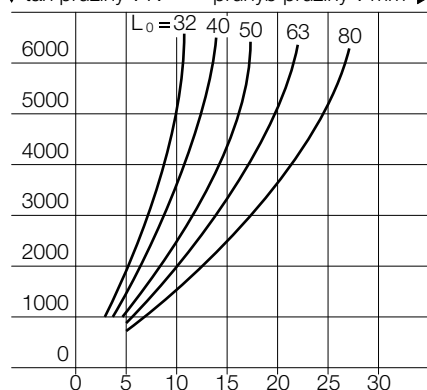

246.5.050.

Ø 50/80 Shore A



▼ tah pružiny v N      průhyb pružiny v mm ▶

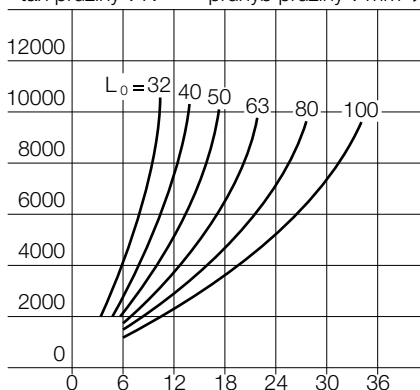

246.5.063.

Ø 63/80 Shore A



▼ tah pružiny v N      průhyb pružiny v mm ▶

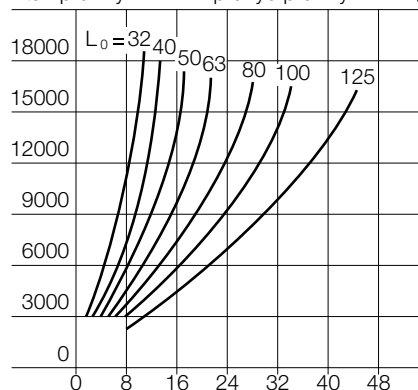

246.5.080.

Ø 80/80 Shore A



▼ tah pružiny v N      průhyb pružiny v mm ▶

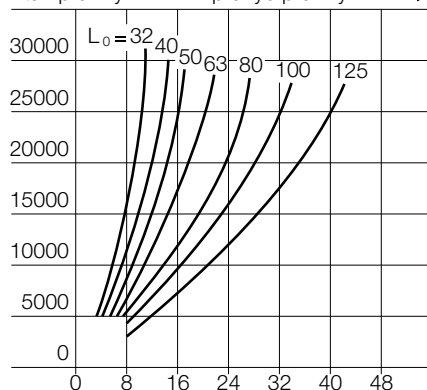

246.5.100.

Ø 100/80 Shore A



▼ tah pružiny v N      průhyb pružiny v mm ▶

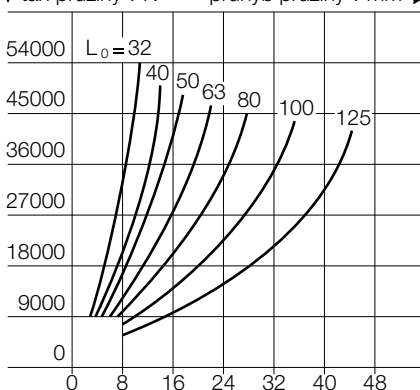

246.5.125.

Ø 125/80 Shore A



▼ tah pružiny v N      průhyb pružiny v mm ▶

