

FIBROFLEX®-KRUHOVÁ PRUŽINA 90 SHORE A, DLE DIN ISO 10069-1

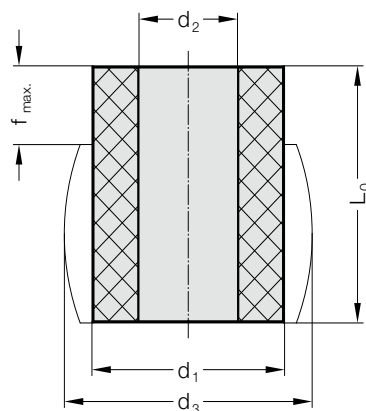

246.6.



Popis:

Pružiny FIBROFLEX® jsou vysoce elastické polyuretanelastomerné výrobky. Tvrdost dle stupnice Shore A je důležitou vlastností pro použitý materiál FIBROFLEX®. Tuto vlastnost je nutno zohlednit při výběru správné tvrdosti pro určité případy použití.

Materiál:

Polyuretan 90 Shore A

Barva: žluté

Upozornění:

Na základě fyzikálních vlastností mají polyuretanové elastomery sklon k "usazení". Ten závisí na vzniklé teplotě třením, okolní teplotě, rychlosti a počtu změn zatížení, zdvihu pružiny a tvrdosti.

Může činit 4 až 7 % délky pružiny L_0 .

246.6. FIBROFLEX®-Kruhová pružina 90 Shore A, dle DIN ISO 10069-1

Objednací číslo	d_1	l_0	d_2	d_3	f max.	F max. [N]	Objednací číslo	d_1	l_0	d_2	d_3	f max.	F max. [N]
246.6.016.012	16	12,5	6,5	21	3,6	1 680	246.6.063.100	63	100	17	81	30	27 300
246.6.016.016	16	16	6,5	21	4,8	1 650	246.6.063.125	63	125	17	81	37,5	26 800
246.6.016.020	16	20	6,5	21	6	1 620	246.6.080.032	80	32	21	104	9,6	53 000
246.6.016.025	16	25	6,5	21	7,5	1 580	246.6.080.040	80	40	21	104	12	50 500
246.6.020.016	20	16	8,5	26	4,8	2 600	246.6.080.050	80	50	21	104	15	48 000
246.6.020.020	20	20	8,5	26	6	2 550	246.6.080.063	80	63	21	104	18,9	46 500
246.6.020.025	20	25	8,5	26	7,5	2 530	246.6.080.080	80	80	21	104	24	45 500
246.6.020.032	20	32	8,5	26	9,6	2 500	246.6.080.100	80	100	21	104	30	44 900
246.6.025.020	25	20	10,5	32	6	4 300	246.6.080.125	80	125	21	104	37,5	44 000
246.6.025.025	25	25	10,5	32	7,5	4 200	246.6.100.032	100	32	21	130	9,6	90 000
246.6.025.032	25	32	10,5	32	9,6	4 150	246.6.100.040	100	40	21	130	12	84 800
246.6.025.040	25	40	10,5	32	12	4 120	246.6.100.050	100	50	21	130	15	81 000
246.6.032.032	32	32	13,5	42	9,6	6 400	246.6.100.063	100	63	21	130	18,9	78 000
246.6.032.040	32	40	13,5	42	12	6 350	246.6.100.080	100	80	21	130	24	75 000
246.6.032.050	32	50	13,5	42	15	6 300	246.6.100.100	100	100	21	130	30	73 000
246.6.032.063	32	63	13,5	42	18,9	6 250	246.6.100.125	100	125	21	130	37,5	71 000
246.6.040.032	40	32	13,5	52	9,6	11 000	246.6.125.032	125	32	27	160	9,6	150 000
246.6.040.040	40	40	13,5	52	12	10 900	246.6.125.040	125	40	27	160	12	142 500
246.6.040.050	40	50	13,5	52	15	10 800	246.6.125.050	125	50	27	160	15	132 000
246.6.040.063	40	63	13,5	52	18,9	10 750	246.6.125.063	125	63	27	160	18,9	125 000
246.6.040.080	40	80	13,5	52	24	10 700	246.6.125.080	125	80	27	160	24	118 000
246.6.050.032	50	32	17	65	9,6	17 400	246.6.125.100	125	100	27	160	30	115 000
246.6.050.040	50	40	17	65	12	17 300	246.6.125.125	125	125	27	160	37,5	113 000
246.6.050.050	50	50	17	65	15	17 000	246.6.125.160	125	160	27	160	48	111 300
246.6.050.063	50	63	17	65	18,9	16 650							
246.6.050.080	50	80	17	65	24	16 500							
246.6.050.100	50	100	17	65	30	16 400							
246.6.063.032	63	32	17	81	9,6	30 100							
246.6.063.040	63	40	17	81	12	29 500							
246.6.063.050	63	50	17	81	15	28 900							
246.6.063.063	63	63	17	81	18,9	28 000							
246.6.063.080	63	80	17	81	24	27 500							

246.6.016.

Ø 16/90 Shore A



▼ tah pružiny v N průhyb pružiny v mm ▶

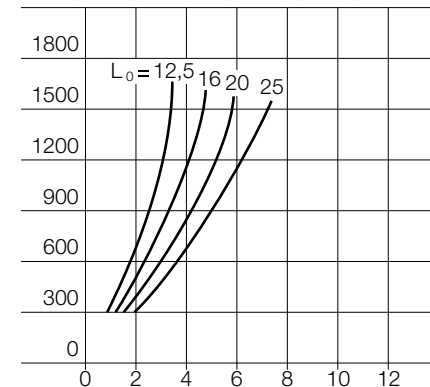



FIBROFLEX®-KRUHOVÁ PRUŽINA 90 SHORE A, DLE DIN ISO 10069-1

246.6.020.

Ø 20/90 Shore A



▼ tah pružiny v N průhyb pružiny v mm ►

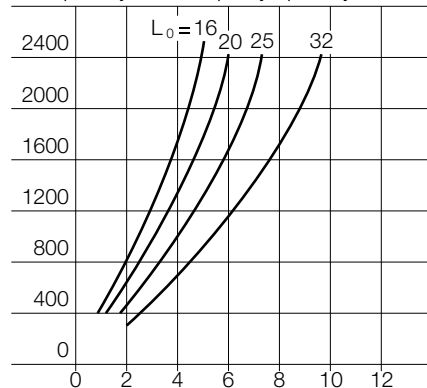

246.6.025.

Ø 25/90 Shore A



▼ tah pružiny v N průhyb pružiny v mm ►

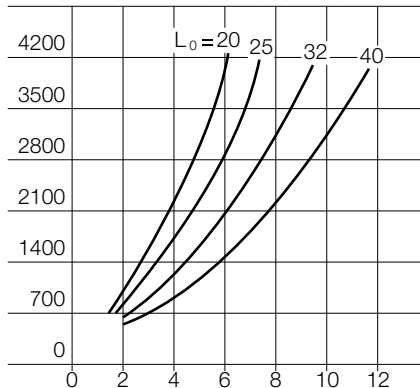

246.6.032.

Ø 32/90 Shore A



▼ tah pružiny v N průhyb pružiny v mm ►

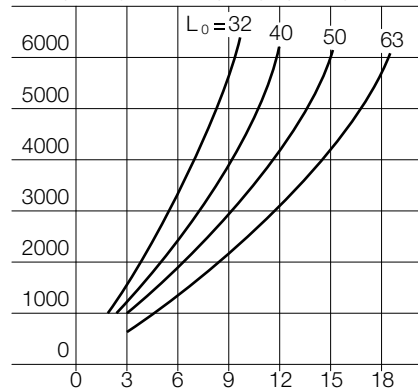

246.6.040.

Ø 40/90 Shore A



▼ tah pružiny v N průhyb pružiny v mm ►

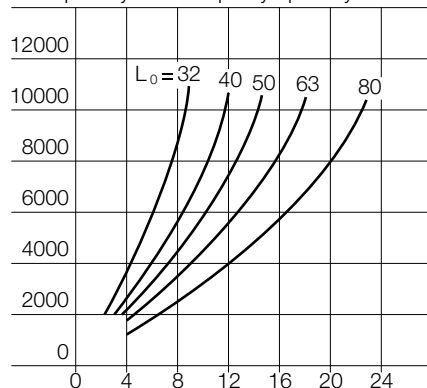

246.6.050.

Ø 50/90 Shore A



▼ tah pružiny v N průhyb pružiny v mm ►

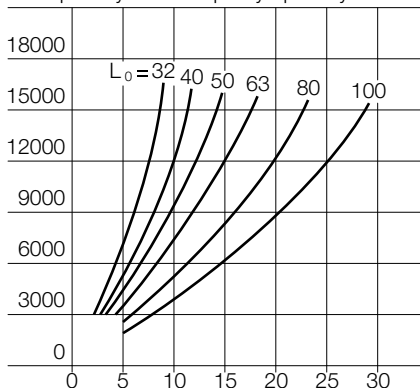

246.6.063.

Ø 63/90 Shore A



▼ tah pružiny v N průhyb pružiny v mm ►

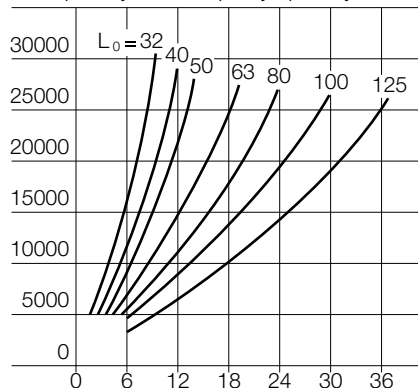

246.6.080.

Ø 80/90 Shore A



▼ tah pružiny v N průhyb pružiny v mm ►

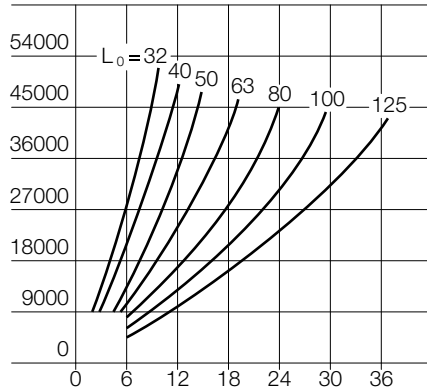

246.6.100.

Ø 100/90 Shore A



▼ tah pružiny v N průhyb pružiny v mm ►

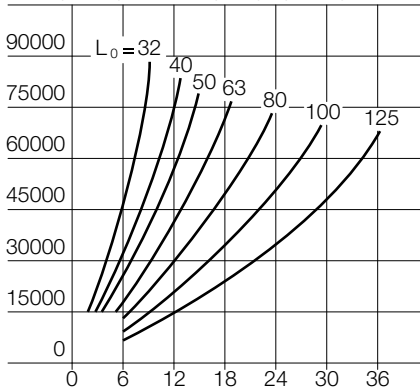

246.6.125.

Ø 125/90 Shore A



▼ tah pružiny v N průhyb pružiny v mm ►

