

FIBROFLEX®-RESSORT RONDS 95 SHORE A, SELON DIN ISO 10069-1

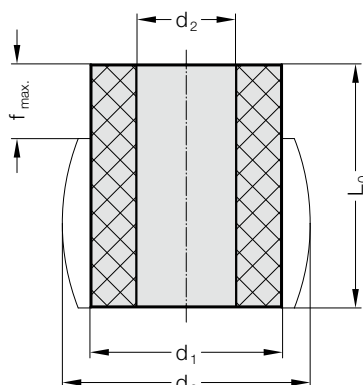

246.7.



Description :

Les ressorts FIBROFLEX® sont réalisés dans un élastomère de polyuréthane à haute élasticité.

La dureté Shore définit les FIBROFLEX®.

Elle est d'une extrême importance pour choisir de façon précise la qualité convenant exactement à l'utilisation recherchée.

Matière :

Polyurethan 95 Shore A

Couleur : rouge

Remarque :

De par leurs propriétés physiques, les élastomères de polyuréthane ont tendance à se tasser. Cette tendance est fonction de l'échauffement par frottement intérieur, du nombre d'alternances et de leur fréquence, de la course du ressort et de la dureté Shore. Le tassement peut atteindre 4 à 7% de la longueur L_0 .

246.7. FIBROFLEX®-Ressort ronds 95 Shore A, selon DIN ISO 10069-1

N° de commande	d ₁	L ₀	d ₂	d ₃	f max.	F max. [N]	N° de commande	d ₁	L ₀	d ₂	d ₃	f max.	F max. [N]
246.7.016.012	16	12,5	6,5	21	3,1	2 000	246.7.063.100	63	100	17	81	25	31 800
246.7.016.016	16	16	6,5	21	4	1 920	246.7.063.125	63	125	17	81	31,2	31 600
246.7.016.020	16	20	6,5	21	5	1 900	246.7.080.032	80	32	21	104	8	62 500
246.7.016.025	16	25	6,5	21	6,2	1 870	246.7.080.040	80	40	21	104	10	59 000
246.7.020.016	20	16	8,5	26	4	3 050	246.7.080.050	80	50	21	104	12,5	58 000
246.7.020.020	20	20	8,5	26	5	3 000	246.7.080.063	80	63	21	104	15,7	55 000
246.7.020.025	20	25	8,5	26	6,2	2 980	246.7.080.080	80	80	21	104	20	54 000
246.7.020.032	20	32	8,5	26	8	2 950	246.7.080.100	80	100	21	104	25	53 000
246.7.025.020	25	20	10,5	32	5	5 100	246.7.080.125	80	125	21	104	31,2	52 000
246.7.025.025	25	25	10,5	32	6,2	5 080	246.7.100.032	100	32	21	130	8	110 000
246.7.025.032	25	32	10,5	32	8	5 020	246.7.100.040	100	40	21	130	10	102 500
246.7.025.040	25	40	10,5	32	10	5 000	246.7.100.050	100	50	21	130	12,5	95 000
246.7.032.032	32	32	13,5	42	8	7 600	246.7.100.063	100	63	21	130	15,7	92 000
246.7.032.040	32	40	13,5	42	10	7 500	246.7.100.080	100	80	21	130	20	89 000
246.7.032.050	32	50	13,5	42	12	7 480	246.7.100.100	100	100	21	130	25	87 000
246.7.032.063	32	63	13,5	42	15,7	7 450	246.7.100.125	100	125	21	130	31,2	86 000
246.7.040.032	40	32	13,5	52	8	13 000	246.7.125.032	125	32	27	160	8	178 000
246.7.040.040	40	40	13,5	52	10	12 700	246.7.125.040	125	40	27	160	10	168 000
246.7.040.050	40	50	13,5	52	12,5	12 500	246.7.125.050	125	50	27	160	12,5	157 000
246.7.040.063	40	63	13,5	52	15,7	12 450	246.7.125.063	125	63	27	160	15,7	150 000
246.7.040.080	40	80	13,5	52	20	12 430	246.7.125.080	125	80	27	160	20	142 000
246.7.050.032	50	32	17	65	8	21 000	246.7.125.100	125	100	27	160	25	135 000
246.7.050.040	50	40	17	65	10	20 100	246.7.125.125	125	125	27	160	31,2	133 000
246.7.050.050	50	50	17	65	12,5	19 600	246.7.125.160	125	160	27	160	40	130 000
246.7.050.063	50	63	17	65	15,7	19 200							
246.7.050.080	50	80	17	65	20	19 100							
246.7.050.100	50	100	17	65	25	19 050							
246.7.063.032	63	32	17	81	8	37 000							
246.7.063.040	63	40	17	81	10	35 900							
246.7.063.050	63	50	17	81	12,5	34 000							
246.7.063.063	63	63	17	81	15,7	33 000							
246.7.063.080	63	80	17	81	20	32 000							

246.7.016.
Ø 16/95 Shore A

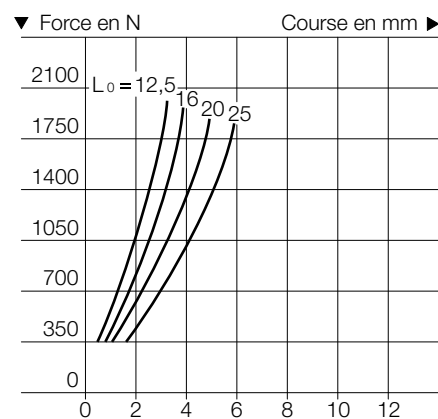



FIBROFLEX®-RESSORT RONDS 95 SHORE A, SELON DIN ISO 10069-1

246.7.020.
Ø 20/95 Shore A

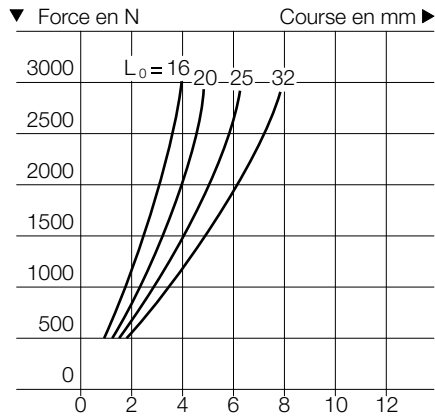

246.7.025.
Ø 25/95 Shore A

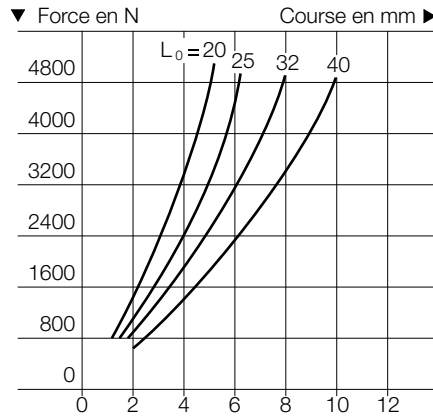

246.7.032.
Ø 32/95 Shore A

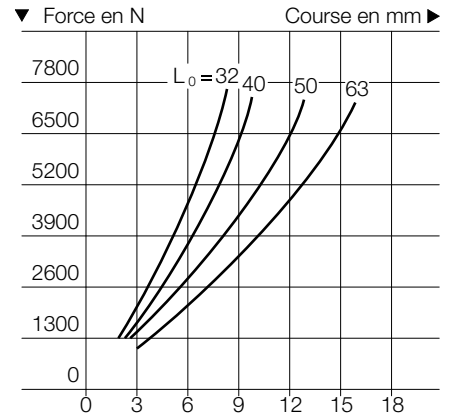

246.7.040.
Ø 40/95 Shore A

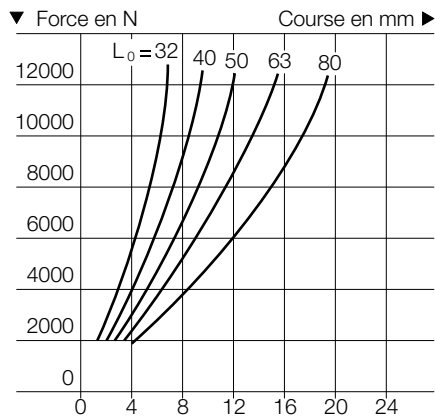

246.7.050.
Ø 50/95 Shore A

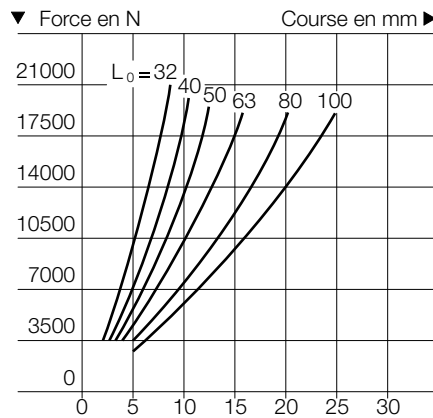

246.7.063.
Ø 63/95 Shore A

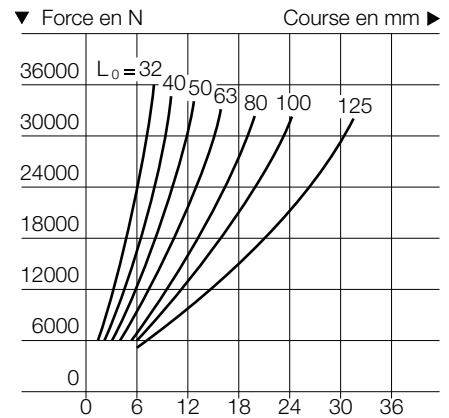

246.7.080.
Ø 80/95 Shore A

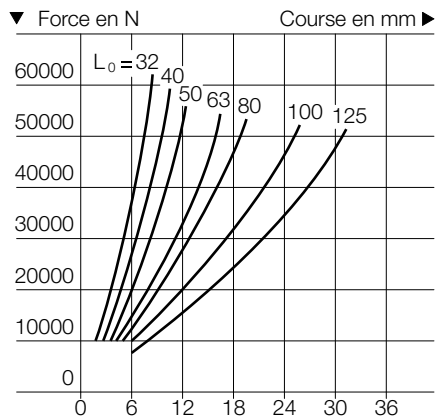

246.7.100.
Ø 100/95 Shore A

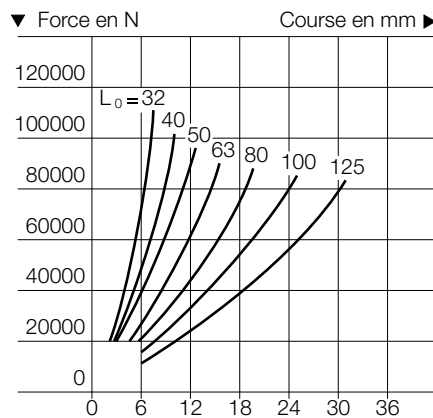

246.7.125.
Ø 125/95 Shore A

