

GAS SPRINGS - INSTALLATION GUIDELINES

Mounting examples

Mounting possibilities for gas springs are listed below.

For additional information on mounting, see the corresponding pages in the catalogue.

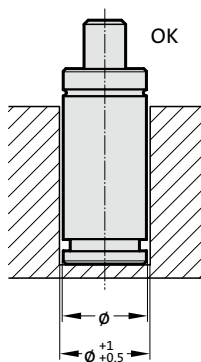

Installed loose in the bore.

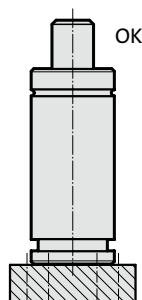

Screw mounted at the base with 2480.011.

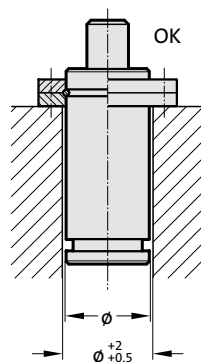

Fixed with 2480.055./057./058./064.

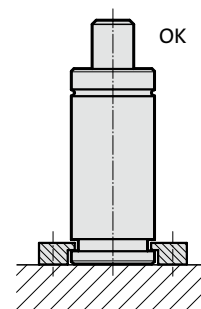
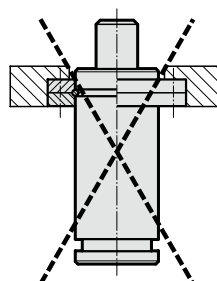

Fixed with 2480.007./008.

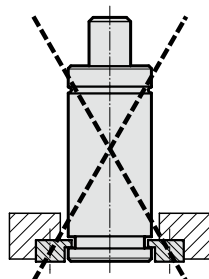

Fixed with 2480.007./008.

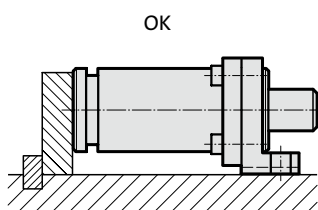

Fixed with 2480.044./045./047.

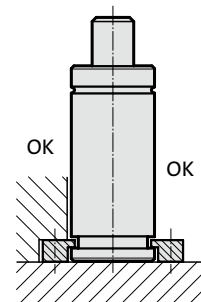
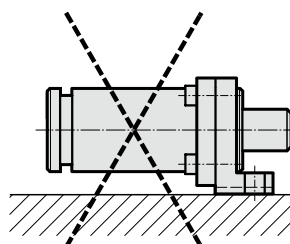

Fixed with 2480.022.

GAS SPRINGS - INSTALLATION GUIDELINES

To achieve the best possible service-life and safety from the gas spring, the directions below must be followed.

Mounting instructions

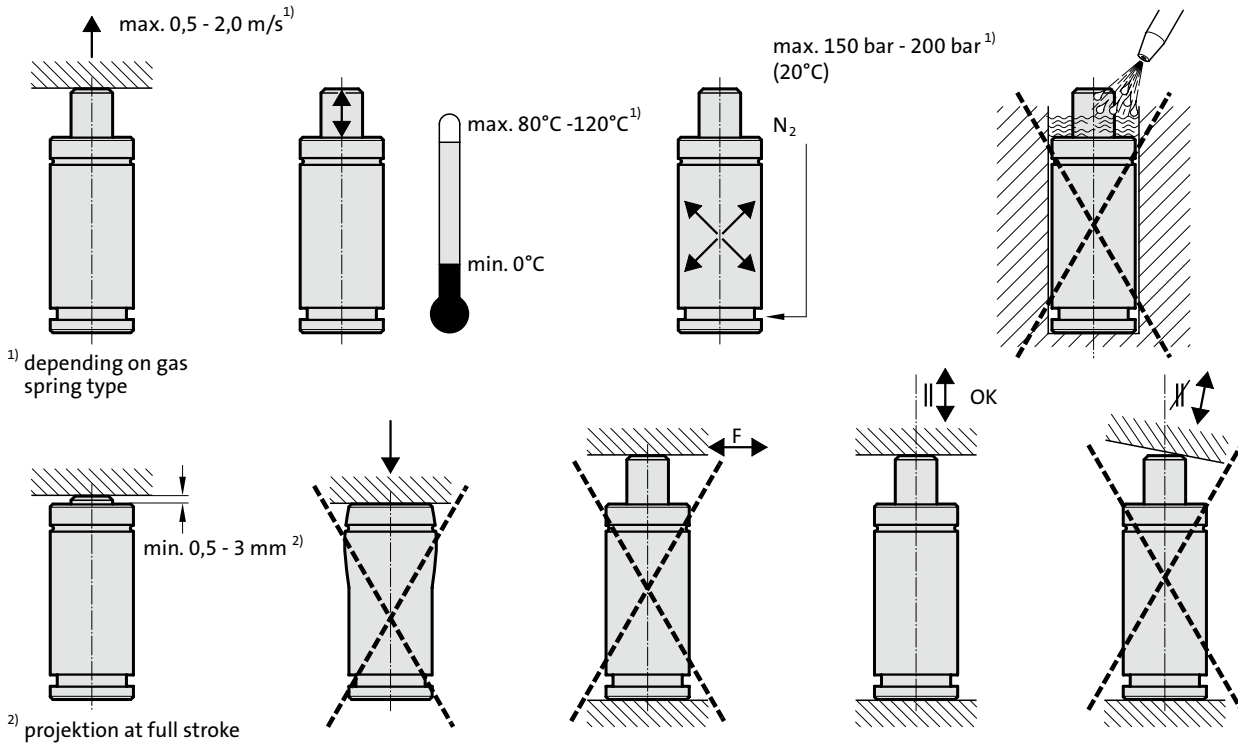

- Secure the gas spring to the tool/machine whenever possible, using the threaded hole(s) in the base of the gas spring or a suitable flange. Never exceed the maximum torque values for the threads in the base of the gas spring: (M6 = 10 Nm; M8 = 24 Nm; M10 = 45 Nm; M12 = 80 Nm)
- The threaded hole in the piston rod top should not be used for mounting purposes. It is only to be used when carrying and servicing the gas spring.
- Do not use the gas spring in such a way that the piston rod is realised freely from its compressed position, as this could cause internal damage to the gas spring.
- Make sure the gas spring is mounted parallel to the direction of the compression stroke.
- Ensure the contact surface of the piston rod top is perpendicular to the direction of the compression stroke and is sufficiently hardened.
- The gas spring should not be subjected to the side loads.
- Protect the piston rod against mechanical damage and contact with fluids.
- We recommend providing a stroke reserve of 10% of the nominal stroke length or 5 mm.
- The maximum charging pressure as a function of the working temperature must not be exceeded as it may effect the safety of the product.
- Exceeding the gas spring's recommended operating temperature will shorten the service-life of the gas spring.
- The entire contact surface of the piston rod / piston should be used (except 2479.030./031., 3479.030.).
- Do not remove bottom 2480./2497.00.20. from spring until all gas pressure has been discharged.