

For new constructions:  
**Series "E2 Tubes"**  
R68 ▶ page 6.34

# Series R68 classic E2 Tubes

45

igus® E-ChainSystems®

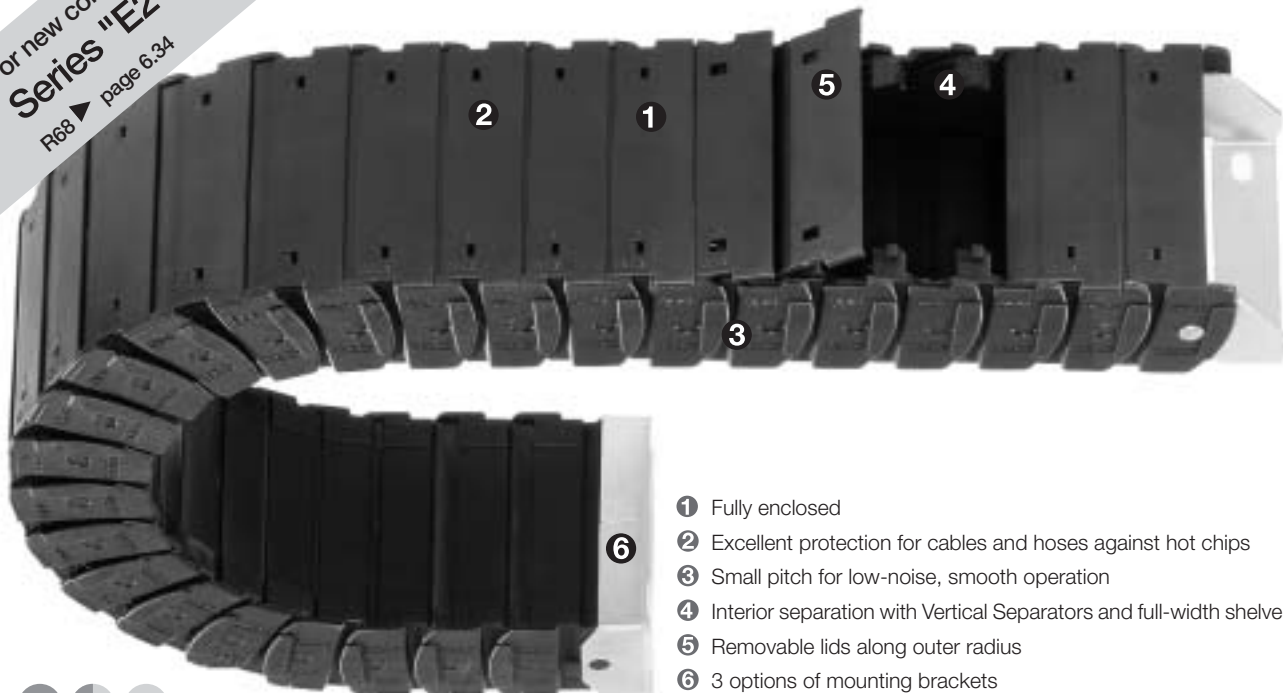

- 1 Fully enclosed
- 2 Excellent protection for cables and hoses against hot chips
- 3 Small pitch for low-noise, smooth operation
- 4 Interior separation with Vertical Separators and full-width shelves
- 5 Removable lids along outer radius
- 6 3 options of mounting brackets

● ● ● Price index

Phone +49- (0) 22 03-96 49-800  
Fax +49- (0) 22 03-96 49-222

igus® GmbH  
51147 Cologne

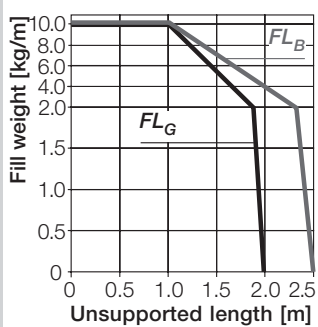

Length of travel S [m]  
0 1 2 3 4 5

Unsupported length

FL<sub>G</sub> = with straight upper run

FL<sub>B</sub> = with permitted sag

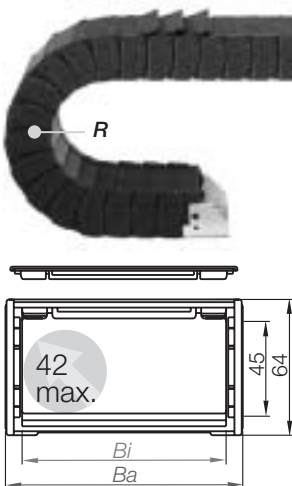
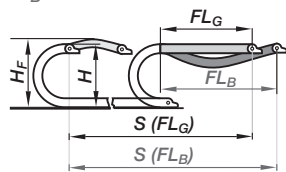

## R68 classic - snap-open along outer radius

Part No.	Bi [mm]	Ba [mm]	R [mm]	Bending Radii
68.1. <input type="text"/> .0	75	93	100	125 150
68.2. <input type="text"/> .0	115	133	200	225 250
68.3. <input type="text"/> .0	175	196	300	
Radii for all widths!				

Completare con il raggio desiderato (R) es. 68.1. 125.0

Bending radii listed above can be combined with every tube width!



Series R68 classic - fully enclosed E-Tube

### Part No. structure



68. 1. 125.0

- Color black
- Bending radius
- Width
- Series



### Order example 3,0 m complete E-Tube

(Indicate tube-lengths or number of links)

3,0 m (84 links) **Series 68.1.125.0**

+ 2 separators **311** assembled each 2<sup>nd</sup> link

+ 1 set mounting brackets **681.12**

# Series R68 classic E2 Tubes

Pitch = 36 mm    Links per m = 28    Chain length =  $S/2 + K$

<b>R</b>	100	125	150	200	225	250	300
<b>H</b>	265	315	365	465	515	565	665
<b>D</b>	200	225	250	300	325	350	400
<b>K</b>	500	650	725	875	975	1050	1225

The required clearance height is  $H_F = H + 40$  mm (with 2,5 kg/m fill weight). Please consult igus® if space is particularly restricted.

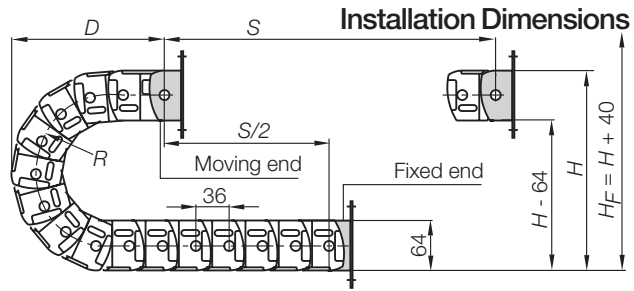

45

E2 Tubes classic  
Inner height: 45 mm

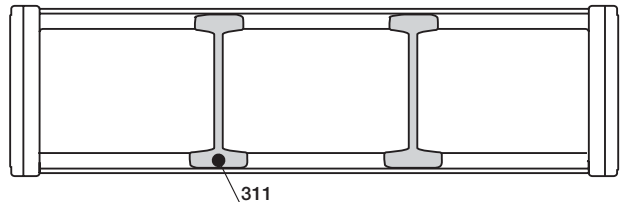

**Vertical Separator**  
 unassembled **301**  
 assembled **311**

**Interior Separation**  
 (the complete range ▶ 6.34)

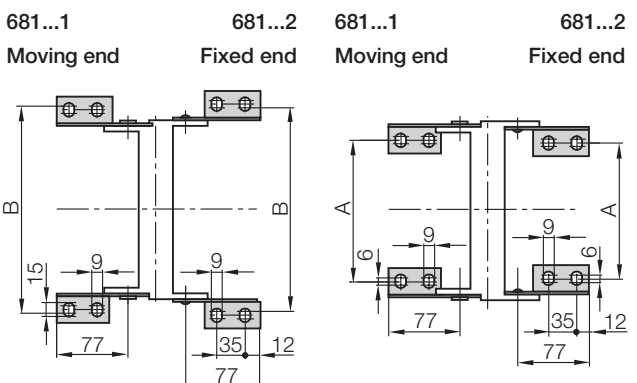

**Moving end (with bore) 681.1**

**Fixed end (with pin) 681.2**

**Mounting Brackets**

681.2 Steel, two-piece, pivoting - attachment with socket head cap bolt M6 DIN 912-8.8

For E-Chain®	Part No.	Dimension A [mm]	Dimension B [mm]
68.1. ▶	681.12	60	112
68.2. ▶	681.12	100	152
68.3. ▶	681.12	160	212

The following parts are required for attachment of the mounting brackets:

- Socket head cap bolt M6\* DIN 912-8.8    4 pieces/set
- Washer 6,3 DIN 125-ST    8 pieces/set
- Hexagon nut M6 DIN 934-8    4 pieces/set

\* The length of the socket head cap bolt is dependent on the thickness of the attachment base.

Full set, for both ends:  
**681. 12**

Single-part order:  
**681. 1**  
 Mounting bracket with bore  
**681. 2**  
 Mounting bracket with pin



Interior separation with full-width shelves and shelves    One-piece, steel mounting bracket, pivoting    Steel mounting bracket, flange, pivoting

**Additional Features**

For more features ▶ see link below