

Teilung = 91 mm    Glieder/m = 11    Kettenlänge =  $S/2 + K$

<b>R</b>	135	150	175	200	240	250	300	350	400	500
<b>H+25</b>	360	385	435	485	565	585	685	785	885	1085
<b>D</b>	270	285	310	335	375	385	435	485	535	635
<b>K</b>	650	750	825	900	1020	1050	1225	1340	1450	1775

Die erforderliche lichte Einbauhöhe ist:  $H_F = H + 50$  mm (bei 2,0 kg/m Zusatzlast). Bei besonders beengten Platzverhältnissen bitte anrufen.

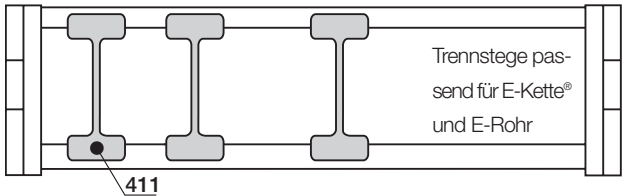
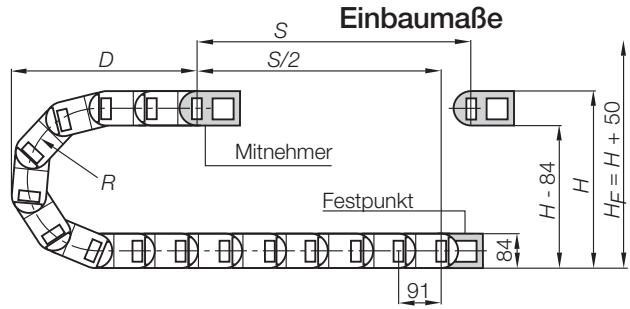

**Trennsteg**

unmontiert	401
montiert	411



**Innenaufteilung**

das komplette Programm ▶ 7.46

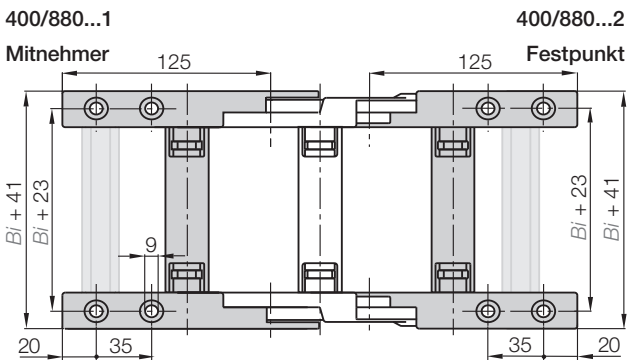

**Mitnehmer mit Bohrung**

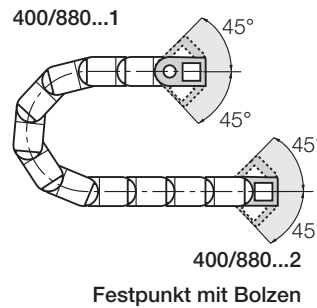

**Anschlusselemente**



**KMA pendelnd - Befestigung**  
mit Zylinderkopfschraube  
M8 DIN 912-8.8

Breiten-Index	Art. Nr. Komplettsatz optional mit C-Profil	Bi [mm]
.05.	400 .....05.12 C	50
.06.	400 .....06.12 C	65
.07.	400/880.07.12 C	75
.10.	400/880.10.12 C	100
.11.	400 .....11.12 C	112
.12.	400/880.12.12 C	125
.13.	400 .....13.12 C	137
.15.	400/880.15.12 C	150
.16.	400 .....16.12 C	162
.17.	400 .....17.12 C	175
.18.	400 .....18.12 C	187
.20.	400/880.20.12 C	200
.21.	400 .....21.12 C	212
.22.	400 .....22.12 C	225
.23.	400 .....23.12 C	237
.25.	400/880.25.12 C	250
.26.	400 .....26.12 C	262
.27.	400/880.27.12 C	275
.28.	400 .....28.12 C	287
.30.	400/880.30.12 C	300
.31.	400 .....31.12 C	312

Breiten-Index	Art. Nr. Komplettsatz optional mit C-Profil	Bi [mm]
.32.	400 .....32.12 C	325
.33.	400 .....33.12 C	337
.35.	400/880.35.12 C	350
.36.	400 .....36.12 C	362
.37.	400 .....37.12 C	375
.38.	400 .....38.12 C	387
.40.	400/880.40.12 C	400
.41.	400 .....41.12 C	412
.42.	400 .....42.12 C	425
.43.	400 .....43.12 C	437
.45.	400/880.45.12 C	450
.46.	400/880.46.12 C	462
.47.	400 .....47.12 C	475
.48.	400 .....48.12 C	487
.50.	400 .....50.12 C	500
.51.	400 .....51.12 C	512
.52.	400 .....52.12 C	525
.53.	400 .....53.12 C	537
.55.	400 .....55.12 C	550
.60.	400 .....60.12 C	600

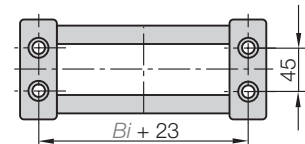

**Bestellbeispiel**

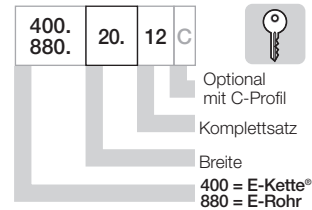

**Komplettsatz für beide Enden:**

400.20. 12

**Bei Einzelteil-Bestellung:**

400.20. 1

Anschlusselement mit **Bohrung**

400.20. 2

Anschlusselement mit **Bolzen**

Variantenreiche Innenaufteilung möglich	Mittelasche für extrem breite E-Ketten	Rastclip für E-Ketten auf der Seite liegend	Erweiterungsbügel für dicke Schläuche	Anschlusselement KMA, starr	Anschlusselement Stahl, starr

**Weitere Features**

Weitere Infos zu diesen Features ▶ siehe untenstehenden Link

E4/0  
Innenhöhe: 56 mm

Tel. +49- (0) 22 03-96 49-800  
Fax +49- (0) 22 03-96 49-222

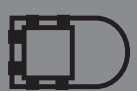

▶ Kapitel 9