

● ● ● Price index

UL94-V2 classifications upon request

ESD classification: Electrically conductive ESD/ATEX version upon request

E-Tubes with HT-material for hot chips up to 850°C available upon request

- ❶ Double stop dog for strong unsupported length
- ❷ Effective chip protection, even against hot metal chips
- ❸ Covered pin/bore connection
- ❹ Lateral glide surfaces for side-mounted operation
- ❺ Snap-open lids along inner or outer radius
- ❻ Lids can be swivelled from the left to the right
- ❼ Space-efficient with optimized ratio of inner dimension to outer dimension
- ❽ Universal KMA mounting brackets with attachment capability on all sides
- ❾ **Strain relief separator** - Separator with integrated strain relief for the use in the first or last chain link ▶ [page 6.25](#)

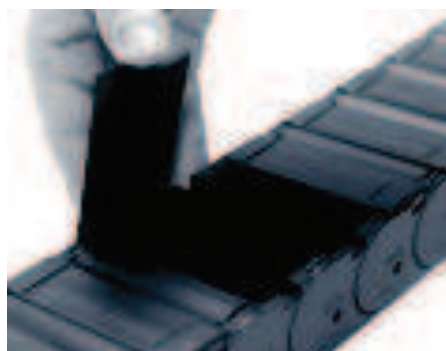

To open the E-Tube Series R100 lift up the lid and swivel lid to the side



When to use the Series R167/R168:

- If snap-open accessibility along inner or outer radius is required
- If a low-cost, lightweight E-Tube for many types of applications required
- If flush attachment is required
- If chip-repellent features are required



When not to use it:

- If snap-open accessibility along both sides is required
 - ▶ **System E4.1, Series R4.42, page 7.48**
- If very smooth travel due to small pitch is required
 - ▶ **Type R, Series R68, page 6.42**

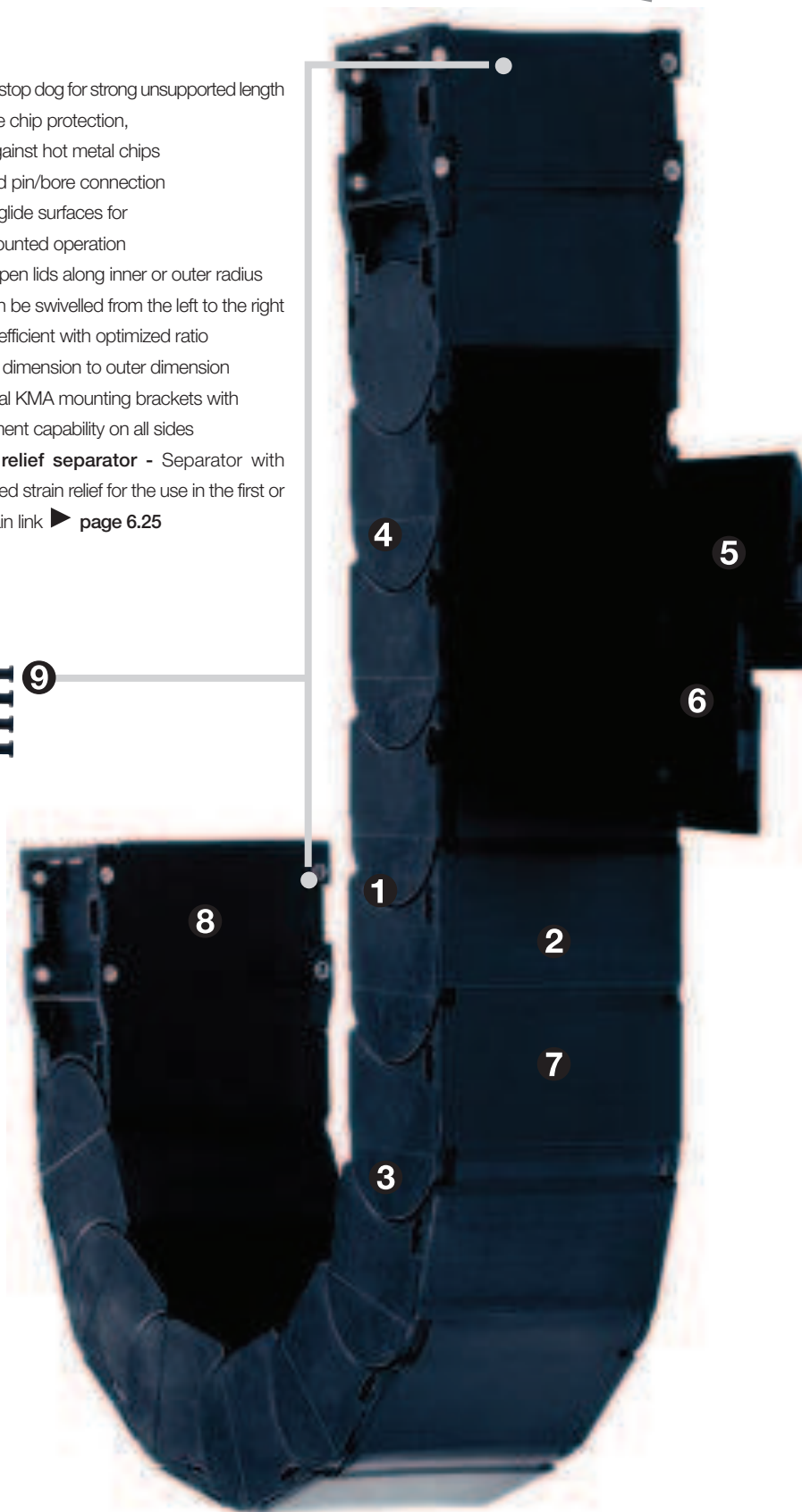

Order example complete E-Tube

Please indicate E-Tube-lengths or number of links **Example: 1 m or 17 links**

1 m **167.100.100.0**

E-Tube

with 2 separators **1686.01** assembled every 2nd link

Interior separation

1 set **1680.100.12**

Mounting bracket



Unsupported length

FL_G = with straight upper run

FL_B = with permitted sag

Further information ► **Design, page 1.12**

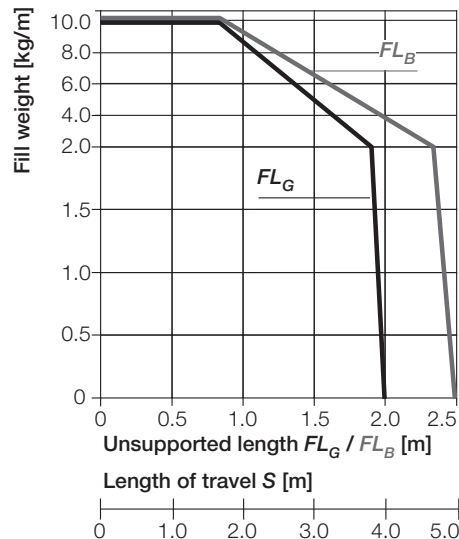
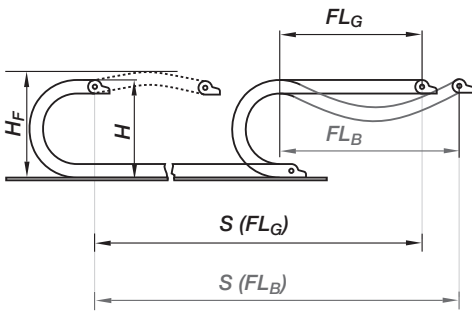

- S = Length of travel
- R = Bending radius
- H = Nominal clearance height
- H_F = Required clearance height
- D = Overlength E-Chain® radius in final position
- $K = \pi \cdot R + \text{"safety"}$

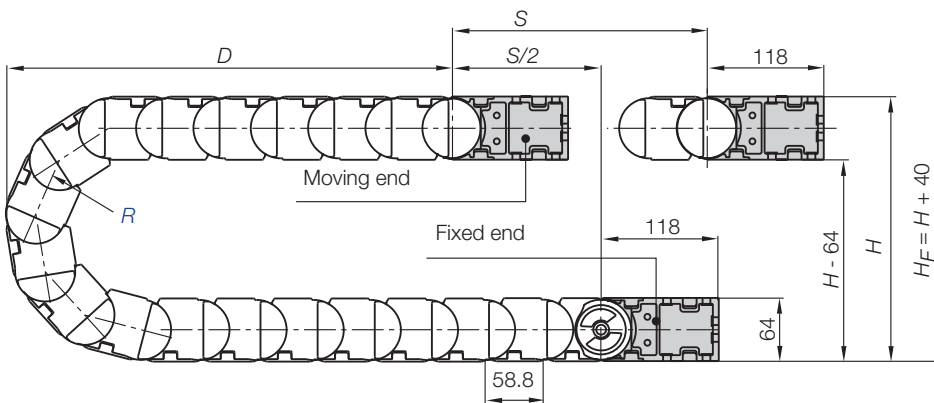

Short travels - unsupported

Unsupported E-Chains® feature positive camber over short travels. This must be accounted for when specifying the clearance height H_F . Please consult igus® if space is particularly restricted.

Pitch = 58,8 mm/link Links/m = 17 (999,6 mm) Chain length = $S/2 + K$

R	100	125	150	175	200	225	250	300
H	264	314	364	414	464	514	564	664
D	180	205	230	255	280	305	330	380
K	440	510	590	670	750	830	910	1060

The required clearance height:
 $H_F = H + 40$ mm
(with 2,0 kg/m fill weight)

Hot Chips up to 850°C

E-Tubes that repel hot chips, up to 850 °C. Some applications, depending on amount and size of the chips, can burn or melt the surface. That is no longer the case with the igus® "igumid HT" material.

Order example - Full E-Tube made of HT*: 168.100.100.0.HT

Order example - Lids made of HT: 168.100HT.100.0

*for long travels upon request

Delivery time up to 4 weeks! Further Information: www.igus.de/en/HT

Speed / acceleration FL_G	max. 10 [m/s] / max. 100 [m/s ²]
Speed / acceleration FL_B	max. 3 [m/s] / max. 6 [m/s ²]
Gliding speed / acceleration (maximum)	max. 0,5 [m/s] / max. 5 [m/s ²]
Material - permitted temperature °C	igumid G / -40° up to +120° C
Flammability class, igumid G	VDE 0304 IIC UL94 HB

Technical Data



Details of material properties
► page 1.38



E2 E-Tubes Type R
Inner height: 50 mm

Phone +49- (0) 22 03-96 49-800
Fax +49- (0) 22 03-96 49-222

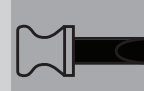

► page 6.5

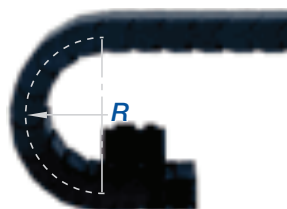
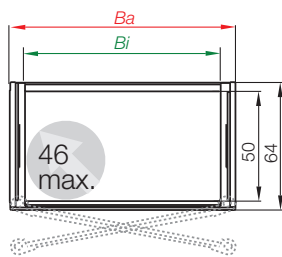

Part No. structure

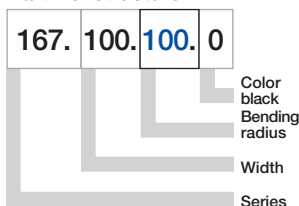

Series R167 - hinged, snap-open on both sides of the inner radius

Part No.	B_i [mm]	B_a [mm]	R [mm]	Bending radii								Weight [kg/m]
167.050.□.0	50	68	100	125	150	175	200	225	250	300	≈ 1,58	
167.075.□.0	75	93	100	125	150	175	200	225	250	300	≈ 1,84	
167.100.□.0	100	118	100	125	150	175	200	225	250	300	≈ 2,09	
167.115.□.0	115	133	100	125	150	175	200	225	250	300	≈ 2,24	
167.125.□.0	125	143	100	125	150	175	200	225	250	300	≈ 2,35	
167.150.□.0	150	168	100	125	150	175	200	225	250	300	≈ 2,60	
167.175.□.0	175	193	100	125	150	175	200	225	250	300	≈ 2,86	
167.200.□.0	200	218	100	125	150	175	200	225	250	300	≈ 3,11	
167.225.□.0	225	243	100	125	150	175	200	225	250	300	≈ 3,37	
167.250.□.0	250	268	100	125	150	175	200	225	250	300	≈ 3,62	

Supplement Part No. with required radius. Example: 167.100.100.0

0 = standard color, other colors ► page 1.39 · Pitch = 58,8 mm/link - Links/m = 17

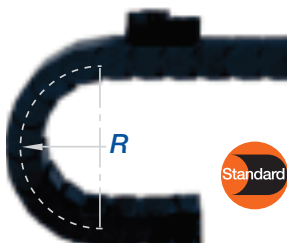
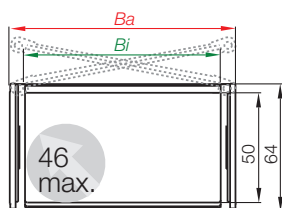

Part No. structure

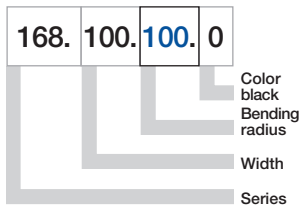

Series R168 - hinged, snap-open on both sides of the outer radius

Part No.	B_i [mm]	B_a [mm]	R [mm]	Bending radii								Weight [kg/m]
168.050.□.0	50	68	100	125	150	175	200	225	250	300	≈ 1,58	
168.075.□.0	75	93	100	125	150	175	200	225	250	300	≈ 1,84	
168.100.□.0	100	118	100	125	150	175	200	225	250	300	≈ 2,09	
168.115.□.0	115	133	100	125	150	175	200	225	250	300	≈ 2,24	
168.125.□.0	125	143	100	125	150	175	200	225	250	300	≈ 2,35	
168.150.□.0	150	168	100	125	150	175	200	225	250	300	≈ 2,60	
168.175.□.0	175	193	100	125	150	175	200	225	250	300	≈ 2,86	
168.200.□.0	200	218	100	125	150	175	200	225	250	300	≈ 3,11	
168.225.□.0	225	243	100	125	150	175	200	225	250	300	≈ 3,37	
168.250.□.0	250	268	100	125	150	175	200	225	250	300	≈ 3,62	

The sizes 125 / 225 / 250 are available upon request. Delivery time: approx. 8-10 weeks after receipt of order

Supplement Part No. with required radius. Example: 168.100.100.0

0 = standard color, other colors ► page 1.39 · Pitch = 58,8 mm/link - Links/m = 17



Option 1: Vertical Separators

Vertical Separators are used if a vertical subdivision of the E-Chain® interior is required -

By standard Vertical Separators are assembled every other E-Chain® link

- **Standard** subdivision with Vertical Separator 1686.01
- **Strain Relief Separator 1686.01.Z**, integrable in the mounting bracket, to position at any point - can be combined with Full-Width Shelf 321.X and Shelf 2210.X

Vertical Separator	
unassembled	1685.01
assembled	1686.01

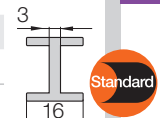

Strain Relief Separator	
unassembled	1685.01.Z
assembled	1686.01.Z

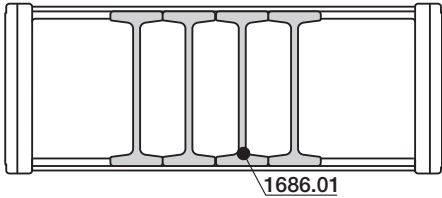
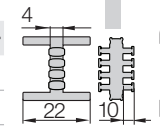

E2 E-Tubes Type R
Inner height: 50 mm

Option 2: Full-Width Shelves

For applications involving many thin cables with similar or identical diameters

- Vertical Separator, slotted 1686.02 for applications with Full-Width Shelf 321.X

Vert. Separator, slotted	
unassembled	1685.02
assembled	1686.02

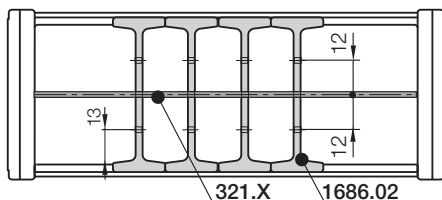
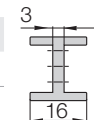

Width X [mm]	Part No. unassembled	Part No. assembled
050	320.050	321.050
075	320.075	321.075
100	320.100	321.100
115	320.115	321.115
125	320.125	321.125

Width X [mm]	Part No. unassembled	Part No. assembled
150	320.150	321.150
175	320.175	321.175
200	320.200	321.200
225	320.225	321.225
250	320.250	321.250

Full-Width Shelf

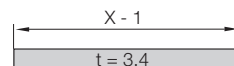

Option 3: Shelves

For applications involving many cables with similar or identical diameters. Partial separation into individual chambers can be achieved and the entire width Bi-10 mm can be used

- Shelf 2210.X can be combined with Middle Plate 1686.03 and Side Plate 1686.04

Middle Plate	
unassembled	1685.03
assembled	1686.03

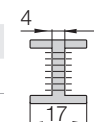

Side Plate	
unassembled	1685.04
assembled	1686.04

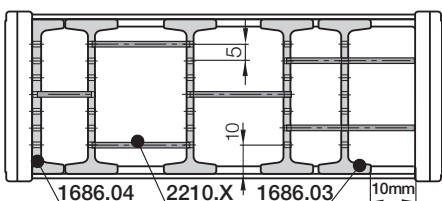
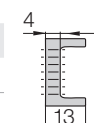

Width X [mm]	Part No. unassembled	Part No. assembled
018	2200.18	2210.18
023	2200.23	2210.23
028	2200.28	2210.28
033	2200.33	2210.33
038	2200.38	2210.38
043	2200.43	2210.43
048	2200.48	2210.48

Width X [mm]	Part No. unassembled	Part No. assembled
058	2200.58	2210.58
068	2200.68	2210.68
073	2200.73	2210.73
088	2200.88	2210.88
099	2200.99	2210.99
124	2200.0124	2210.124
149	2200.0149	2210.149

Shelf

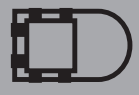
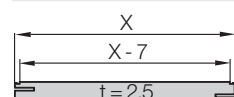

▶ page 6.5

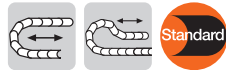

Option KMA* - pivoting

- Recommended for unsupported and gliding applications
- Option - KMA with Quickflange, bolted connection outside of E-Tube cross-section
- Universal mountable with attachment capability on all sides
- Locked connection to E-Tube
- Long travels with lowered mounting height possible
- Corrosion-resistant

*KMA = Polymer Metal Mounting Bracket

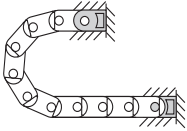

The attachment variants arising automatically by the choice of the KMA mounting bracket

Moving end (outer link)
1680...1

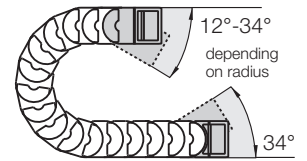

1680...2

Fixed end (inner link)

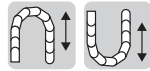

Option KMA - locking

- Recommended for vertical hanging / standing applications
- Option - KMA with Quickflange, bolted connection outside of E-Tube cross-section
- At very high speed and acceleration
- Universal mountable with attachment capability on all sides
- Flush mounting at both ends of the E-Tube

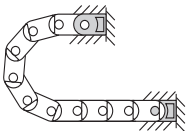

The attachment variants arising automatically by the choice of the KMA mounting bracket

Moving end (outer link)
1680...1

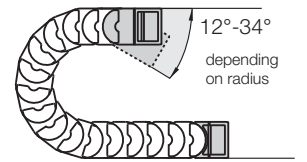

1680...4

Fixed end (inner link)

Dimensions and order configurations



Quickflange upon request

Part No. structure (pivoting)

1680.100.12.A



A... must be indicated on preassembled configurations
Full set pivoting = 12
Width
KMA for selected chain type

Full set, for both ends:

1680.100.12

Single-part order:

1680.100.1

Mounting bracket with bore

1680.100.2

Mounting bracket with pin

Part No. structure (locking)

1680.100.14.A

A... must be indicated on preassembled configurations
Full set locking = 14
Width
KMA for selected chain type

Full set, for both ends:

1680.100.14

Single-part order:

1680.100.1

Mounting bracket with bore

1680.100.4

Mounting bracket with pin

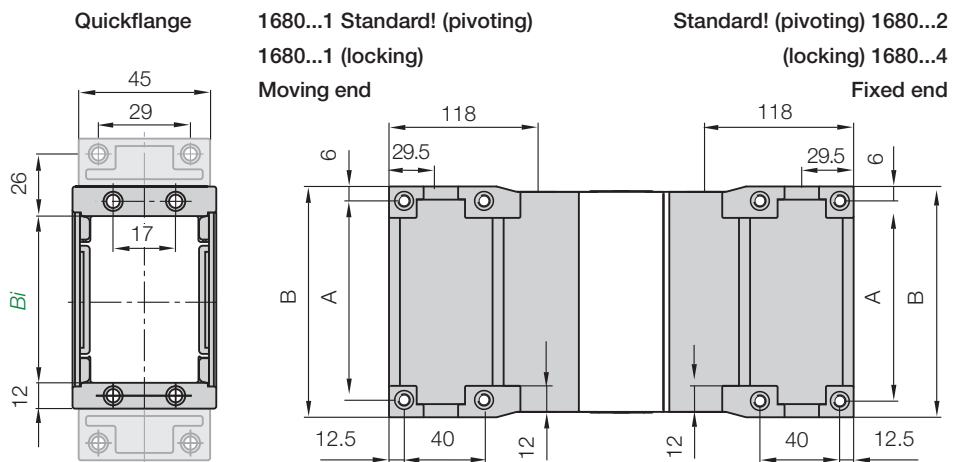

For Series	Part No. full set	Part No. full set with Quickflange	Dim. A [mm]	Dim. B [mm]
167-168.050	1680.050.	1680.050. QF	62	74
167-168.075	1680.075.	1680.075. QF	87	99
167-168.100	1680.100.	1680.100. QF	112	124
167-168.115	1680.115.	1680.115. QF	127	139
167-168.125	1680.125.	1680.125. QF	137	149
167-168.150	1680.150.	1680.150. QF	162	174
167-168.175	1680.175.	1680.175. QF	187	199
167-168.200	1680.200.	1680.200. QF	212	224
167-168.225	1680.225.	1680.225. QF	237	249
167-168.250	1680.250.	1680.250. QF	262	274

Please add the Part No. with the requested index - 12 for the pivoting configuration

e.g. 1680.100.12 or 14 for the locking configuration e.g. 1680.100.14

For the preassembled mode please add the index A e.g. 1680.100.12.A

Quickflange unassembled: Part No. 16800.QF

The following parts are required for attachment of the mounting brackets:

- Socket head cap bolt M5 DIN 912-8.8 Length depends on the thickness of the attachment base
- Washer 5,3 DIN 125-ST ● Hexagon nut M5 DIN 934-8



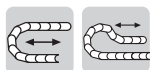

Flange mounting brackets made of steel

- Metallic flange brackets with popular hole patterns, easily be replaced by their modern successors, without having to alter the hole pattern
- Bolted connection outside of chain cross-section possible
- Universal mountable with attachment capability on all sides
- Steel, galvanized
- One-piece mounting bracket
- High stability

Moving end (outer link)
905.050.X

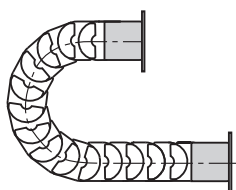

905.050.X
Fixed end (inner link)

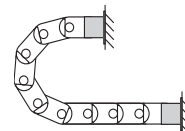

Flush mounting possibilities at both ends of the E-Tube

Hole patterns flange steel mounting brackets 905.050.X

905.050.X
Moving end

905.050.X
Fixed end

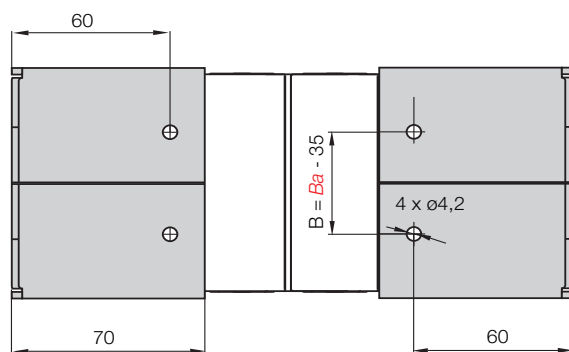
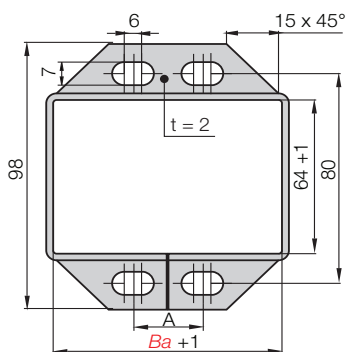

Dimensions and order configurations

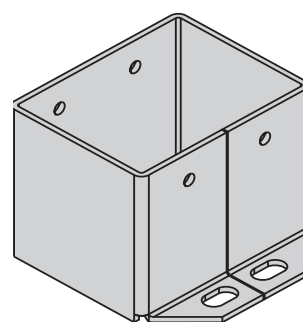

Principle sketch flange steel mounting brackets



Mounting only with hexagon socket DIN 912 M6 and washer DIN 125, 6,3 mm

For Series	Hole pattern	Part No. full set	Bi [mm]	Ba [mm]	Dim. A [mm]	Dim. B [mm]
R168.075	68.01	905.050.1	75	93	30	58
R168.115	68.02	905.050.2	115	133	50	98
R168.175	68.03	905.050.3	175	193	100	158

R100 | Serie R167·R168 | Accessories | Strain Relief

Strain relief separator

Separator with integrated strain relief, for use in the first or last chain link. For manufacturing of switchgear cabinets or for the assembly of machines. Easy to assemble without any fastening device. Separator base **1658.01.Z** is 22 mm wide. The possible number of separators per E-Chain® is defined by its inner width *Bi* and by the cable-diameter. **Details ▶ chapter 10**

Part No.	Number of teeth	For Series
1658.01.Z	4 both sides	R167/168 E-Tube

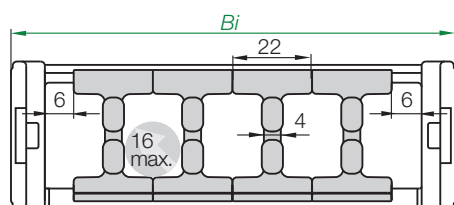
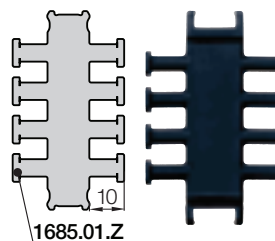

Strain Relief Separator - The number of separators is depending on the cables and the available inner space. Example: E-Chain® inner width *Bi* 100 mm: 4 Strain Relief Separator, max. cable diameter 16 mm.

Details ▶ chapter 10



Other strain relief elements
▶ chapter 10

Phone +49- (0) 22 03-96 49-800
Fax +49- (0) 22 03-96 49-222



▶ chapter 10



▶ page 6.5