

● ● ● Price index



IPA Qualification Certificate:
Air Cleanless Class ISO Class 2
(at v = 1 m/s) upon request



UL94-V2
classifications



Torsional
motion possible



Special equipment:
Electrically conductive ESD/ATEX
version upon request



Just push the cables with your thumb
into the E-Chain® - and it's ready



When to use the Series E26/Z26:

- If filling is required without opening and closing lids
- If price is an issue
- If quiet operation is required



When not to use it:

- For applications with very high loads and long unsupported travel lengths
 - ▶ Series 3400/3450/3480/3500 E2/000, page 5.126
- If a E-Chain® is needed with a high locking crossbar
 - ▶ Series 3400/3450/3480/3500 E2/000, page 5.126

- 1 Limited torsion tolerance
- 2 Large pins for long service life
- 3 Cable-friendly interior
- 4 Integrated strain relief option
- 5 "E" Series features split crossbar along the outer radius
- 6 "Z" Series features split crossbar along the inner radius
- 7 Dirt-repellent exterior
- 8 Very easy to fill
- 9 1-, 2- or 3-chamber system available
- 10 The patented push-button principle holds the links together



Order example complete E-Chain®

Please indicate chain-lengths or number of links **Example: 1 m or 18 links**

1 m E26.07.150.0



E-Chain®

1 set 2607.34.PZB



Mounting bracket



Unsupported length

FL_G = with straight upper run
 FL_B = with permitted sag
 Further information ► **Design, page 1.12**

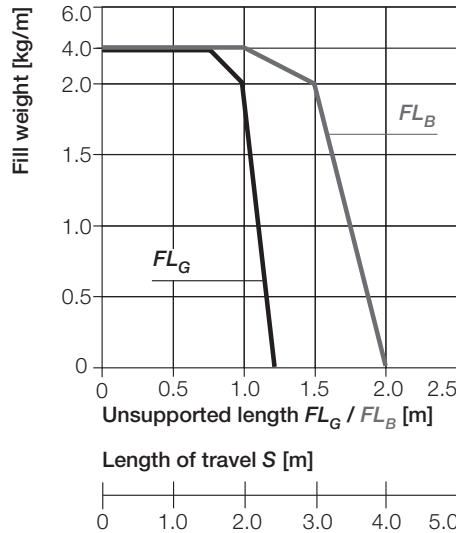
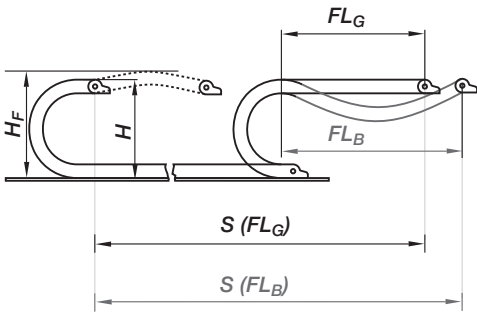

- S = Length of travel
- R = Bending radius
- H = Nominal clearance height
- H_F = Required clearance height
- D = Overlength E-Chain® radius in final position
- $K = \pi \cdot R + \text{"safety"}$

Other installation methods

- Vertical, hanging ≤ 10 m
- Vertical, standing $\leq 1,5$ m
- Side mounted, un supp. $\leq 0,5$ m
- Rotary requires further calculation
- Unsupported length of upper run = upon request

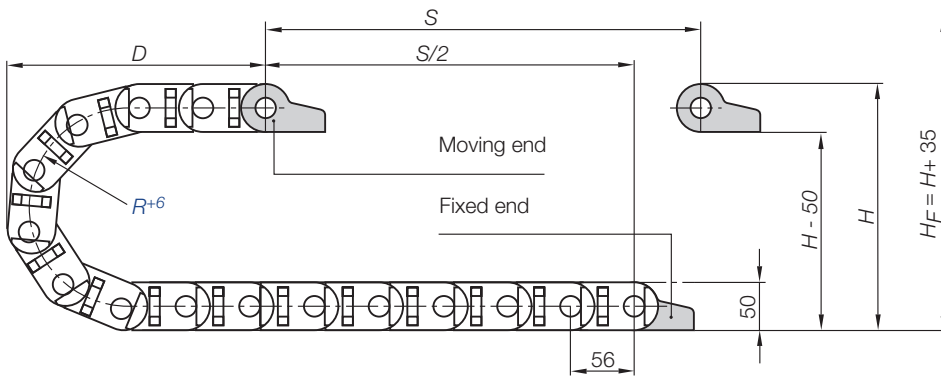

Short travels - unsupported

Unsupported E-Chains® feature positive camber over short travels. This must be accounted for when specifying the clearance height H_F . Please consult igus® if space is particularly restricted.

Pitch = 56 mm/link Links/m = 18 (1.008 mm) Chain length = $S/2 + K$

R	063	075	100	125	150	175	200	250
$H +5$	180	200	250	300	350	400	450	550
D	140	150	175	200	225	250	275	325
K	335	375	475	550	650	750	825	925

The required clearance height:
 $H_F = H + 35$ mm
 (with 2,0 kg/m fill weight)

Speed / acceleration FL_G	max. 20 [m/s] / max. 200 [m/s ²]
Speed / acceleration FL_B	max. 3 [m/s] / max. 6 [m/s ²]
Gliding speed / acceleration (maximum)	max. 3 [m/s] / max. 10 [m/s ²]
Material (E-Chain®)- permitted temperature °C	igumid NB / -40° up to +80° C
Material (mounting brackets)* - permitted temperature °C	igumid G / -40° up to +120° C
Flammability class (E-Chain®), igumid NB	VDE 0304 IIC UL94 V2
Flammability class (mounting brackets), igumid G*	VDE 0304 IIC UL94 HB

*Available in igumid NB upon request, please consult igus® for delivery time

Technical Data



Details of material properties
 ► page 1.38



Easy Chain®
 Inner height: 36,5 mm

Phone +49- (0) 22 03-96 49-800
 Fax +49- (0) 22 03-96 49-222

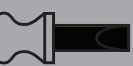
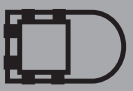

► page 3.5

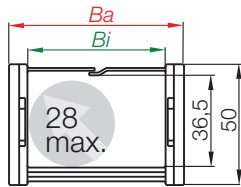

Series E26 - split crossbar along the outer radius

Part No.	Bi [mm]	Ba [mm]	R [mm]	Bending radii								Weight [kg/m]
E26.07. <input type="text"/> .0	75	92	<input type="text"/>	<input type="text"/>	<input type="text"/>	<input type="text"/>	<input type="text"/>	<input type="text"/>	<input type="text"/>	<input type="text"/>	<input type="text"/>	≈ 0,96

Ba: pin dimension approx. 0,3 - 0,5 mm wider!

Supplement Part No. with required radius. Example: E26.07. .0

0 = standard color, other colors ▶ page 1.39 · Pitch = 56 mm/link - Links/m = 18

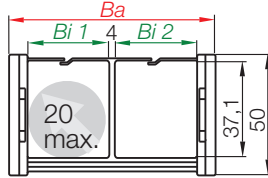

Series E26 - split crossbar along the outer radius with 2-chamber system

Part No.	Bi [mm]	Ba [mm]	R [mm]	Bending radii								Weight [kg/m]
E26.2/45. <input type="text"/> .0	48/48	117	<input type="text"/>	<input type="text"/>	<input type="text"/>	<input type="text"/>	<input type="text"/>	<input type="text"/>	<input type="text"/>	<input type="text"/>	<input type="text"/>	≈ 1,14

Ba: pin dimension approx. 0,3 - 0,5 mm wider!

Supplement Part No. with required radius. Example: E26.2/45. .0

0 = standard color, other colors ▶ page 1.39 · Pitch = 56 mm/link - Links/m = 18

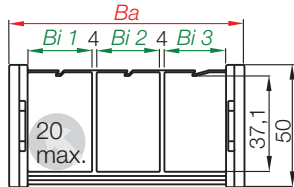

Series E26 - split crossbar along the outer radius with 3-chamber system

Part No.	Bi [mm]	Ba [mm]	R [mm]	Bending radii								Weight [kg/m]
E26.3/45. <input type="text"/> .0	47/48/47	167	<input type="text"/>	<input type="text"/>	<input type="text"/>	<input type="text"/>	<input type="text"/>	<input type="text"/>	<input type="text"/>	<input type="text"/>	<input type="text"/>	≈ 1,30

Ba: pin dimension approx. 0,3 - 0,5 mm wider!

Supplement Part No. with required radius. Example: E26.3/45. .0

0 = standard color, other colors ▶ page 1.39 · Pitch = 56 mm/link - Links/m = 18

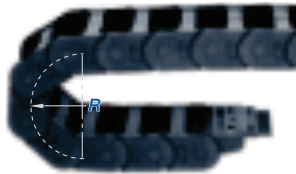

Part No. structure

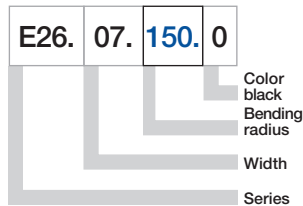

Series Z26 - split crossbar along the inner radius

Part No.	Bi [mm]	Ba [mm]	R [mm]	Bending radii	Weight [kg/m]
Z26.07. <input type="text"/> .0	75	92	063	075 100 125 150 175 200 250	≈ 0,96

Ba: pin dimension approx. 0,3 - 0,5 mm wider!

Supplement Part No. with required radius. Example: Z26.07. 150 .0

0 = standard color, other colors ▶ page 1.39 · Pitch = 56 mm/link - Links/m = 18

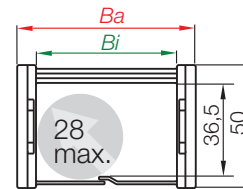

Series Z26 - split crossbar along the inner radius with 2-chamber system

Part No.	Bi [mm]	Ba [mm]	R [mm]	Bending radii	Weight [kg/m]
Z26.2/45. <input type="text"/> .0	48/48	117	063	075 100 125 150 175 200 250	≈ 1,14

Ba: pin dimension approx. 0,3 - 0,5 mm wider!

Supplement Part No. with required radius. Example: Z26.2/45. 150 .0

0 = standard color, other colors ▶ page 1.39 · Pitch = 56 mm/link - Links/m = 18

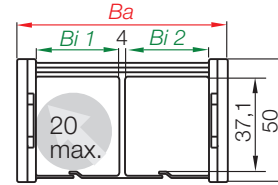

Series Z26 - split crossbar along the inner radius with 3-chamber system

Part No.	Bi [mm]	Ba [mm]	R [mm]	Bending radii	Weight [kg/m]
Z26.3/45. <input type="text"/> .0	47/48/47	167	063	075 100 125 150 175 200 250	≈ 1,30

Ba: pin dimension approx. 0,3 - 0,5 mm wider!

Supplement Part No. with required radius. Example: Z26.3/45. 150 .0

0 = standard color, other colors ▶ page 1.39 · Pitch = 56 mm/link - Links/m = 18

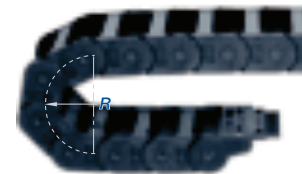
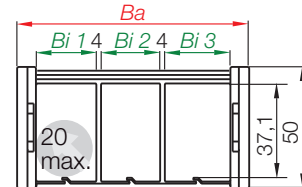

Part No. structure

Z26.	07.	150.	0
------	-----	------	---

Color
black
Bending
radius
Width
Series

Easy Chain®
Inner height: 36,5 mm

Phone +49- (0) 22 03-96 49-800
Fax +49- (0) 22 03-96 49-222



▶ page 3.5

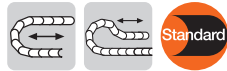

The Standard - option polymer - pivoting

- Recommended for unsupported and gliding applications
- Well suited for tight installation conditions
- Strain relief with detachable tiewrap plates
- Variable traverse angle for flexible assembly
- The twistability of the E-Chain® and the option to assemble the mounting brackets on the fixed end and/or the moving end, enable various installation options

Moving end with bore
(outer link) 26...3PZ(B)

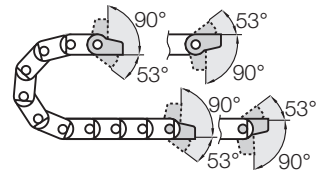

26...4PZ(B) Fixed end
with pin (inner link)

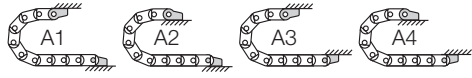

Possible installation conditions for assembled mounting brackets ► Order example "preassembled" below

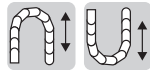

Option polymer - locking

- Recommended for unsupported and gliding applications
- Furthermore:
 - At very high speed and/or acceleration
 - If space is limited for height (the H_F measurement)
 - The twistability of the E-Chain® and the option to assemble the mounting brackets on the fixed end and/or the moving end, enable various installation options

Moving end with bore
(outer link) 26...1PZ(B)

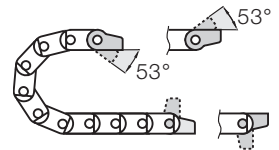

26...2PZ(B) Fixed end
with pin (inner link)

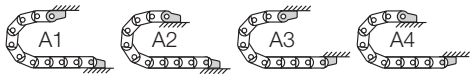

Possible installation conditions for assembled mounting brackets ► Order example "preassembled" below

Dimensions and order configurations

Strain relief is possible on the moving end and/or the fixed end.

Part No. structure (pivoting)

2607.	34	PZB	A1	<p>A... must be indicated on preassembled configurations with assembled tiewrap plates Full set pivoting = 34 Mounting brackets for selected chain type</p>

Full set, for both ends:

2607. 34 PZB +tiewrap plate

Single-part order:

2607. 3 PZB +tiewrap plate

Mounting bracket with bore

2607. 4 PZB +tiewrap plate

Mounting bracket with pin

Part No. structure (locking)

2607.	12	PZB	A1	<p>A... must be indicated on preassembled configurations with assembled tiewrap plates Full set locking = 12 Mounting brackets for selected chain type</p>

Full set, for both ends:

2607. 12 PZB +tiewrap plate

Single-part order:

2607. 1 PZB +tiewrap plate

Mounting bracket with bore

2607. 2 PZB +tiewrap plate

Mounting bracket with pin

26...3PZ(B) Standard! (pivoting)

26...1PZ(B) (locking)

Moving end

Standard! (pivoting) 26...4PZ(B)

(locking) 26...2PZ(B)

Fixed end

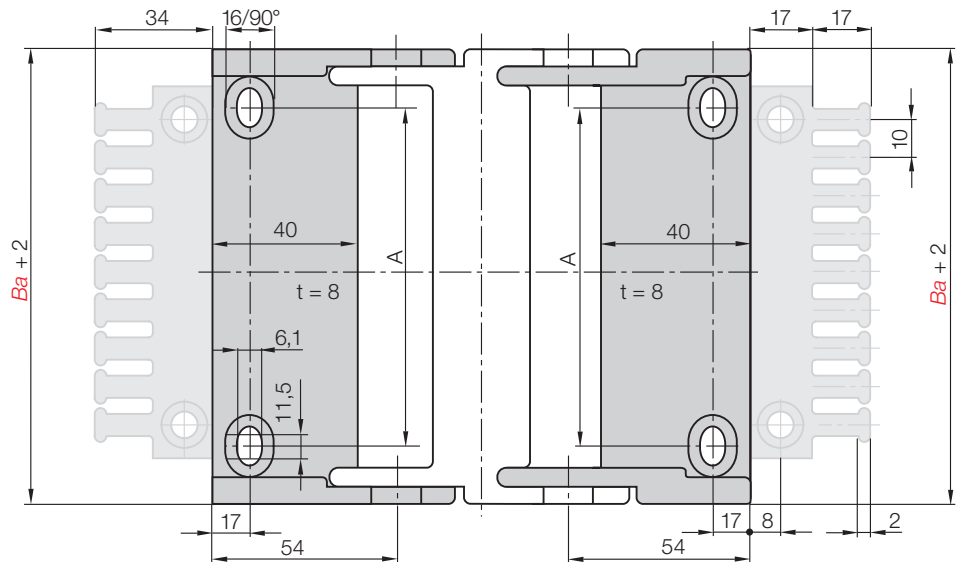

For E-Chain®	Part No. full set with tiewrap plate	Part No. tiewrap plate + 10 cable tiewraps	Part No. full set without tiewrap plate	Number of teeth	Dim. A [mm]
E26-Z26.07	2607. [] PZB	2607. [] PZBK1	2607. [] PZ	7	55
E26-Z26.2/45	2610. [] PZB	2610. [] PZBK1	2610. [] PZ	10	80
E26-Z26.3/45	2615. [] PZB	2615. [] PZBK1	2615. [] PZ	15	130

Please add the Part No. with the requested index - 34 for the pivoting configuration

e.g. 2607. 34 PZB or 12 for the locking configuration e.g. 2607. 12 PZB

For the preassembled mode please add the index A1...A4 e.g. 2607. 34 PZB A1

Strain relief for polymer mounting brackets (pivoting or locking)

The strain relief tiewrap plates can be directly snapped onto the mounting bracket. After bolting the mounting brackets to the machine, the strain relief tiewrap plates are also firmly connected to the base. They do not need to be bolted on separately. Cable tiewraps secured the tiewrap plate "teeth" and the cable provide proper strain relief and save time. **Details ▶ chapter 10**



Tiewrap plate	No. of teeth <i>n</i>	Dim. C [mm]	Dim. B [mm]	Center bore
3050.ZB	5	50	30	-
3075.ZB	7	75	55	-
3100.ZB	10	100	80	-
3115.ZB	11	115	95	-
3125.ZB	12	125	105	-
3150.ZB	15	150	130	-
3175.ZB	17	175	155	-
3200.ZB	20	200	180	+
3225.ZB	22	225	205	+
3250.ZB	25	250	230	+

(- = no / + = yes)

Tiewrap plate as individual part

As individual component screwed on or can be plugged in the mounting brackets. **Details ▶ chapter 10**

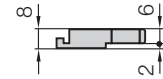
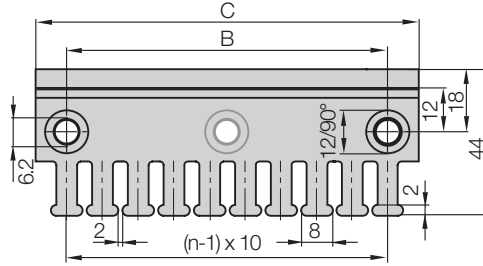

Single tiewrap plate

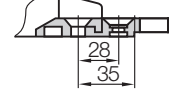

Shown assembled

Cable tiewraps as individual part

Cable tiewraps 100 pieces/bag	Width x length	Max. Ø	Tensile strength
CFB.001	4,8 x 150 mm	36 mm	222 N



Other strain relief elements - optional ▶ chapter 10

Easy Chain®
Inner height: 36,5 mm

Phone +49- (0) 22 03-96 49-800
Fax +49- (0) 22 03-96 49-222

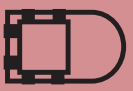

▶ chapter 10

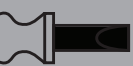

▶ page 3.5