

Stable due to undercut design, medium inner height

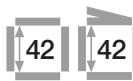

e-chains® Series E4.42 | Crossbars every link (crossbars removable along the inner and outer radius)
 e-chains® Series H4.42 | Crossbars every 2nd link (crossbars removable along the inner and outer radius)
 e-tubes Series R4.42 | Fully enclosed (lids openable along the outer radius, from one side)

Part No.	Bi	Ba	E4.42	H4.42	R4.42	Part No.	Bi	Ba	E4.42	H4.42	R4.42
e-chains® / e-tubes	[mm]	[mm]	[kg/m]	[kg/m]	[kg/m]	e-chains® / e-tubes	[mm]	[mm]	[kg/m]	[kg/m]	[kg/m]
E4.1) H4. R4.2) 42. 05. R.0	50	76	≈ 2.10	≈ 2.05	≈ 2.74	E4. H4. - 42. 212. R.0	212	239	≈ 2.94	≈ 2.46	-
E4.1) H4. - 42. 06. R.0	68	94	≈ 2.21	≈ 2.10	-	E4. H4. - 42. 23. R.0	225	251	≈ 3.02	≈ 2.51	-
E4.1) H4. R4. 42. 07. R.0	75	101	≈ 2.24	≈ 2.12	≈ 3.05	E4. H4. - 42. 237. R.0	237	264	≈ 3.05	≈ 2.52	-
E4.1) H4. R4. 42. 087. R.0	87	114	≈ 2.30	≈ 2.15	≈ 3.20	E4. H4. R4. 42. 25. R.0	250	276	≈ 3.16	≈ 2.58	≈ 5.44
E4. H4. - 42. 097. R.0	97	123	≈ 2.35	≈ 2.17	-	E4. H4. - 42. 262. R.0	262	289	≈ 3.23	≈ 2.61	-
E4.1) H4. R4. 42. 10. R.0	100	126	≈ 2.37	≈ 2.18	≈ 3.34	E4. H4. - 42. 28. R.0	275	301	≈ 3.29	≈ 2.64	-
E4. H4. R4. 42. 11. R.0	108	134	≈ 2.42	≈ 2.20	≈ 3.39	E4. H4. - 42. 29. R.0	287	314	≈ 3.32	≈ 2.65	-
E4. H4. - 42. 112. R.0	112	139	≈ 2.43	≈ 2.21	-	E4. H4. R4. 42. 30. R.0	300	326	≈ 3.42	≈ 2.71	≈ 6.09
E4. H4. R4. 42. 12. R.0	125	151	≈ 2.52	≈ 2.26	≈ 3.58	E4. H4. - 42. 312. R.0	312	339	≈ 3.44	≈ 2.72	-
E4. H4. - 42. 137. R.0	137	164	≈ 2.57	≈ 2.28	-	E4. H4. - 42. 325. R.0	325	351	≈ 3.53	≈ 2.76	-
E4.1) H4. R4. 42. 15. R.0	150	176	≈ 2.64	≈ 2.32	≈ 3.87	E4. H4. - 42. 337. R.0	337	364	≈ 3.58	≈ 2.79	-
E4. H4. - 42. 162. R.0	162	189	≈ 2.66	≈ 2.33	-	E4. H4. - 42. 350. R.0	350	376	≈ 3.77	≈ 2.88	-
E4. H4. R4. 42. 17. R.0	168	194	≈ 2.73	≈ 2.36	≈ 4.10	E4. H4. - 42. 362. R.0	362	389	≈ 3.85	≈ 2.92	-
E4.1) H4. - 42. 18. R.0	175	201	≈ 2.75	≈ 2.37	-	E4. H4. - 42. 375. R.0	375	402	≈ 3.91	≈ 2.95	-
E4. H4. - 42. 187. R.0	187	214	≈ 2.79	≈ 2.39	-	E4. H4. - 42. 387. R.0	387	414	≈ 3.97	≈ 2.98	-
E4.1) H4. R4. 42. 20. R.0	200	226	≈ 2.90	≈ 2.44	≈ 4.44	E4. H4. - 42. 400. R.0	400	426	≈ 4.02	≈ 3.01	-

1) ⚠ ESD version available from stock 2) Removable lid, non-openable

*Radius not available for e-tubes

Available bend radii

R [mm] | 075* | 100* | 115* | 125 | 150 | 160 | 175 | 200 | 250 | 300 | 350 |

Complete Part No. with required radius (R). Example:

E4.42.30.300.0 = crossbars every link / H4.42.30.300.0 = crossbars every 2nd link / R4.42.30.300.0 = fully enclosed

ESD - many sizes from stock

- Standardised product made from igumid ESD
- ESD material tested with over 10 million cycles for the toughest requirements
- Short delivery times including mounting brackets and interior separation; 24hrs, from stock

More information ► www.igus.co.uk/esd



Unsupported applications | Short travels

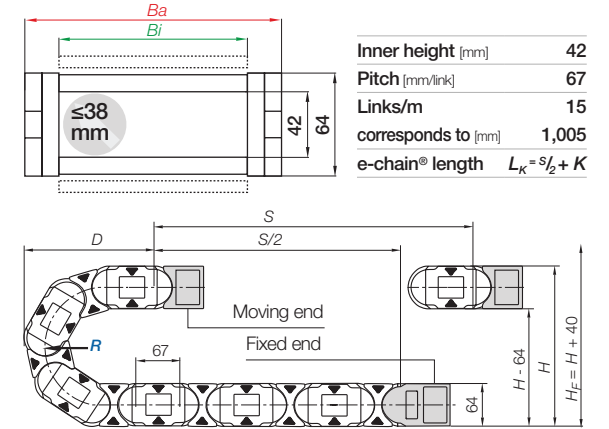
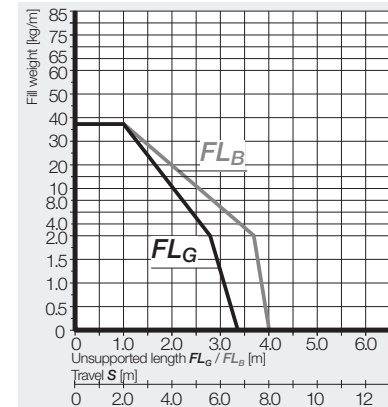

R	075*	100*	115*	125	150	160	175	200	250	300	350
H ₀₋₂₅	214	264	294	314	364	384	414	464	564	664	764
D	208	233	248	258	283	293	308	333	383	433	483
K	370	450	500	530	610	640	685	765	920	1,080	1,235

The required clearance height: $H_F = H + 40\text{mm}$ (with 3.0kg/m fill weight)

*Radius not available for e-tubes

Gliding applications | For long travels from 12m to max. 300m

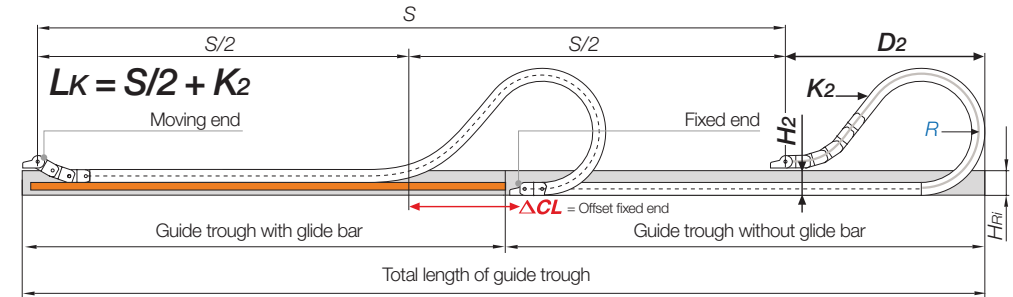

Note: We recommend the project planning of such a system to be carried out by igus®.

In case of travels between 8 and 12m we recommend an e-chain® with a longer unsupported length.

R	075*	100*	115*	125	150	160	175	200	250	300	350
H ₂	150	200	230	186	186	186	186	186	186	186	186
D ₂₊₂₅	174	199	435	475	570	623	670	780	1,030	1,150	1,500
K ₂	370	450	737	804	938	1,072	1,139	1,340	1,675	1,943	2,412
ΔACL	-	-	200	230	300	380	380	460	660	730	1,030

*Radius not available for e-tubes

E4.1 | e-chains® E4.42·H4.42 | Accessories

KMA mounting brackets | Attachment from any side | Pivoting | Locking

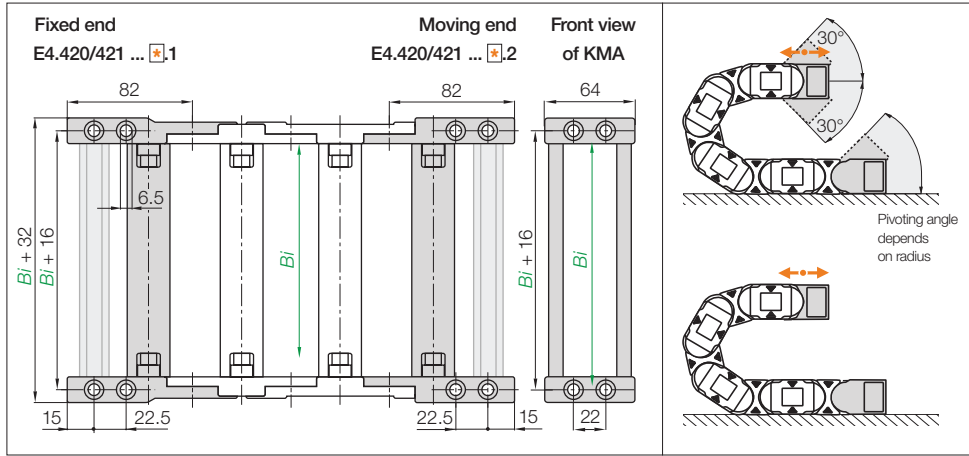

KMA pivoting | Recommended for unsupported and gliding applications
KMA locking | Recommended for vertical hanging and standing applications

Width index	Part No. full set KMA pivoting	Part No. full set KMA locking	Bi [mm]	Width index	Part No. full set KMA pivoting	Part No. full set KMA locking	Bi [mm]
05.	E4.420.05	E4.421.05	50	212.	E4.420.212	E4.421.212	212
06.	E4.420.06	E4.421.06	68	23.	E4.420.23	E4.421.23	225
07.	E4.420.07	E4.421.07	75	237.	E4.420.237	E4.421.237	237
087.	E4.420.087	E4.421.087	87	25.	E4.420.25	E4.421.25	250
09.	E4.420.097	E4.421.097	97	262.	E4.420.262	E4.421.262	262
10.	E4.420.10	E4.421.10	100	28.	E4.420.28	E4.421.28	275
11.	E4.420.11	E4.421.11	108	29.	E4.420.29	E4.421.29	287
112.	E4.420.112	E4.421.112	112	30.	E4.420.30	E4.421.30	300
12.	E4.420.12	E4.421.12	125	312.	E4.420.312	E4.421.312	312
137.	E4.420.137	E4.421.137	137	325.	E4.420.325	E4.421.325	325
15.	E4.420.15	E4.421.15	150	337.	E4.420.337	E4.421.337	337
162.	E4.420.162	E4.421.162	162	350.	E4.420.350	E4.421.350	350
17.	E4.420.17	E4.421.17	168	362.	E4.420.362	E4.421.362	362
18.	E4.420.18	E4.421.18	175	375.	E4.420.375	E4.421.375	375
187.	E4.420.187	E4.421.187	187	387.	E4.420.387	E4.421.387	387
20.	E4.420.20	E4.421.20	200	400.	E4.420.400	E4.421.400	400

(KMA = polymer metal mounting bracket) For the C-profile option please add index .C

E4.1 | e-tubes R4.42 | Accessories

KMA mounting brackets | Attachment from any side | Pivoting | Locking

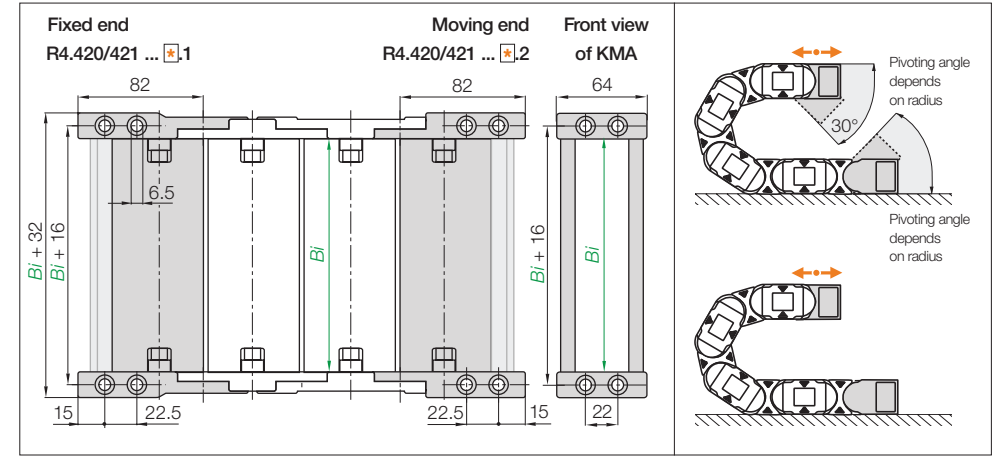

KMA pivoting | Recommended for unsupported and gliding applications
KMA locking | Recommended for vertical hanging and standing applications

Width index	Part No. full set KMA pivoting	Part No. full set KMA locking	Bi [mm]	Width index	Part No. full set KMA pivoting	Part No. full set KMA locking	Bi [mm]
05.	R4.420.05	R4.421.05	50	15.	R4.420.15	R4.421.15	150
07.	R4.420.07	R4.421.07	75	17.	R4.420.17	R4.421.17	168
087.	R4.420.087	R4.421.087	087	20.	R4.420.20	R4.421.20	200
10.	R4.420.10	R4.421.10	100	25.	R4.420.25	R4.421.25	250
11.	R4.420.11	R4.421.11	108	30.	R4.420.30	R4.421.30	300
12.	R4.420.12	R4.421.12	125				

(KMA = polymer metal mounting bracket) For the C-profile option please add index .C

Note: The e-chains® may end with either an inner or an outer side link. An outer side link should always be the first e-chain® link at the moving end. Please specify the index 1 (for odd) or 2 (for even) depending on an even or odd number of links required. Please add index .A2 for the preassembled standard version with C-profile, in the inner radius at the moving end and in the outer radius at the fixed end.

E4.420.30.2.12.C.A2 Order example

- .A... To indicate option with brackets pre-fitted
- C-profile option
- Full set
- Even numbers of links
- Width index
- Series

Strain relief e.g. clamps, tie-wrap plates, nuggets and plug-in clips are available from stock. The complete chainfix range with ordering options ▶ From page 1300

Interior separation | Increase cable service life

Previous generation of interior separation with other options ► www.igus.co.uk/E4.42

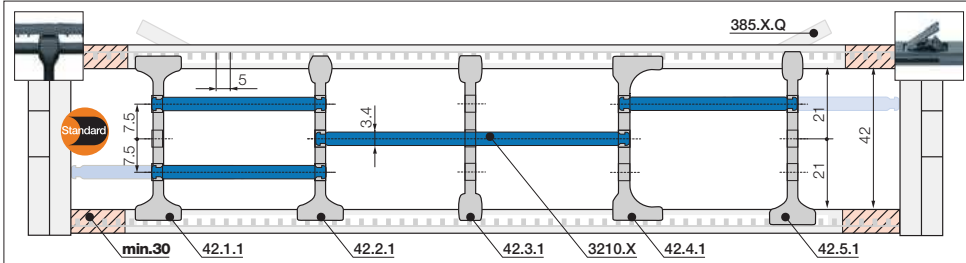

Note: Please be aware of the minimum lateral gap to the side links! **e-tubes: 30mm**
As standard separators are fitted every 2nd e-chain® link!

		Standard separator, wide base
		unassembled 42.1 assembled 42.1.1

Standard - for any application
Separator with a wide base for maximum holding force in the e-chain®.

		Separator for QuickLock crossbar
		unassembled 42.2 assembled 42.2.1

For even faster installation
Separator for igus® QuickLock crossbar **385.X.Q.** Wide on one side for high holding force, narrow on opposite side for easy cable fitting.

		Separator, narrow
		unassembled 42.3 assembled 42.3.1

For small cables
Separator with a narrow base for a large number of small cables side by side. Saves space in the e-chain®. Also available for QuickLock crossbars.

		Separator, asymmetrical
		unassembled 42.4 assembled 42.4.1

For side-mounted applications
Asymmetrical separator, for defined gap distance. No additional spacers required.

		Notch separator for notched crossbar
		unassembled 42.5 assembled 42.5.1

Locks securely in preset increments
Notch separator for exact positioning in e-chains®. Recommended for side-mounted applications.

		Shelf, lockable
		unassembled 3200.X assembled 3210.X

Horizontal separation
Full-width shelf locks securely into separators at both ends, giving a fixed width. Can be used as full-width or partial shelf.

Shelves Width = X [mm]	X [mm]		X [mm]		X [mm]			
	unassembled	assembled	unassembled	assembled	unassembled	assembled		
050	3200.050	3210.050	125	3200.125	3210.125	225	3200.225	3210.225
075	3200.075	3210.075	150	3200.150	3210.150	250	3200.250	3210.250
100	3200.100	3210.100	175	3200.175	3210.175			
115	3200.115	3210.115	200	3200.200	3210.200			

Interior separation | To allow faster filling

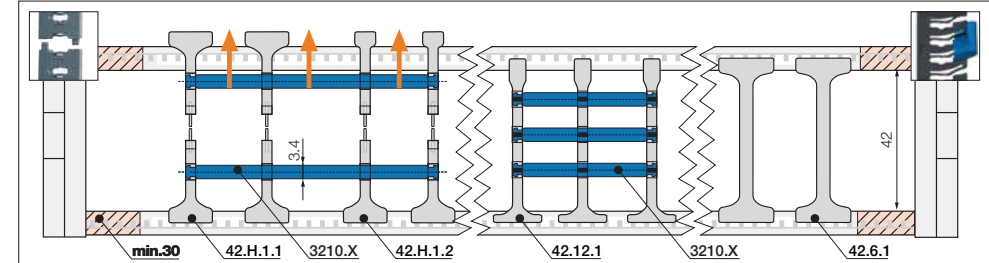

Note: Please be aware of the minimum lateral gap to the side links! **e-tubes: 30mm**
As standard separators are fitted every 2nd e-chain® link!

		Split separator, wide base/top
		unassembled 42.H.1 assembled 42.H.1.1

Split separators
In order to fill e-chains® more easily and effectively, these separators can be split in the middle. This allows easier access to middle shelf partitions. Fast assembly and easy retrofit. 2 types available: with wide or narrow top.

		Split separator, narrow top
		unassembled 42.H.2 assembled 42.H.2.1

		Lean separator
		unassembled 42.12 assembled 42.12.1

Lean separators *New*
New design allows extremely fast fitting of shelves in several layers, which significantly reduces assembly time. Enables extremely fast replacement of individual cables in a very full e-chain®.

Lean separator design - several layers of cables fitted quickly, save up to 50%* assembly time
(*Lean separator vs. standard separator - measured on a 4m long e-chain® fitted with 12 cables in the igus® readychain® factory)



More interior separation options

		Notch locking separator
		unassembled 42.6 assembled 42.6.1

Notch locking separator for increased holding force
Notch locking separators offer higher crossbar opening forces for high humidity and/or large hydraulic hoses. They can be positioned precisely and then locked in position.

TUB **New**

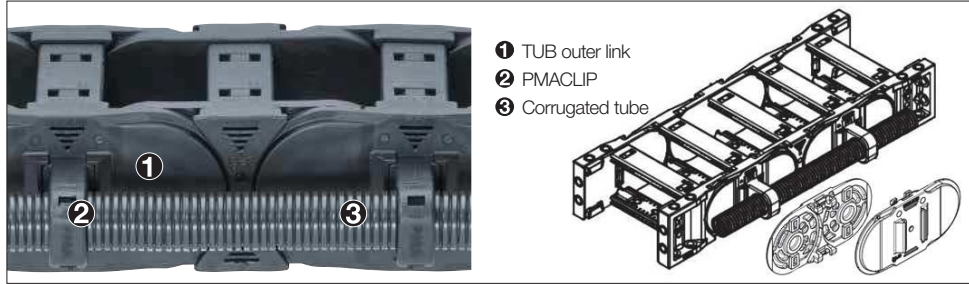

TUB | Safe guidance for corrugated tubes parallel to the e-chain®

- Additional, simple guidance for corrugated tubes on the outside of the e-chain®
- PMACLIP allows corrugated tubes with nominal widths 07, 10, 12, 17mm to be easily clipped on
- Easy access to the corrugated tubes, fast replacement of the hoses
- Reduce assembly time and cost - easy to assemble, without any additional screws or tools
- The part number includes the e-chain® with TUB side sections; the PMACLIP support and the hose are ordered separately

Part No. TUB	Part No. TUB	Part No. TUB	For corrugated tube nominal diameter
Outer link right*	Outer link left*	Outer link at both ends*	Ø [mm]
E4.42.XXXTUBR.R.0	E4.42.XXXTUBL.R.0	E4.42.XXXTUB.R.0	07 / 10 / 12 / 17

*As viewed from the fixed end

Part number appended with width index **XXX Bi** and radius (**R**) e.g.

E4.42.100TUBR.150.0 = with TUB outer sections every 2nd right hand link

Product range | PMACLIP | Support, one-piece, with safety clip

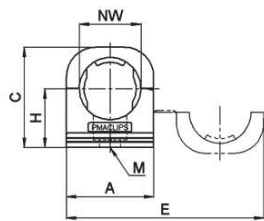

PMACLIP support - one-piece construction with safety clip, suitable for corrugated tubes

Part No.	NW	A	B	C	H	E	M
PMACLIP	Ø [mm]	mm	mm	mm	mm	mm	mm
I-BFH-07-0	07	17.0	20.0	21.5	13.5	40.5	M4
I-BFH-10-0	10	20.5	20.0	24.5	15.5	47.5	M5
I-BFH-12-0	12	24.0	20.0	27.0	16.5	54.5	M5
I-BFH-17-0	17	30.0	20.0	34.0	20.0	68.0	M6

e-chain® with openable extender crossbars **New**

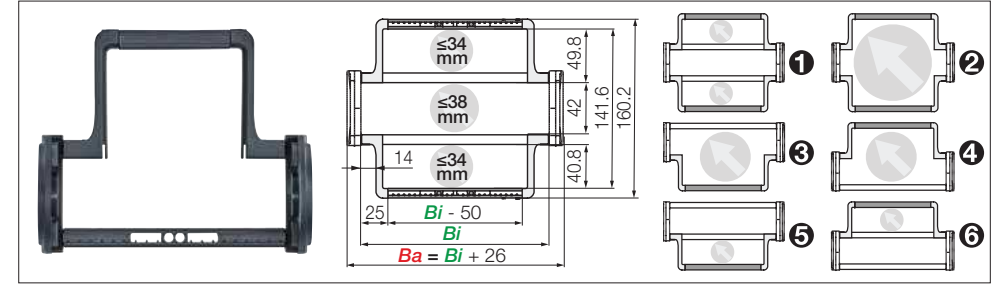

Extender crossbars with flexible width | Safe guiding for large hoses

- For guiding and protecting large hoses
- With mounting for noise dampers
- Cable-friendly design, high crossbar holding force
- The openable extender crossbars can be fitted in different ways and combinations
- Optionally openable along the inner or outer radius

Versions	Hose	Part No.	Part No.
e-chain® with extender crossbar	Ø ≤ [mm]	crossbars every link	crossbars every 2 nd link
1 Extender crossbar and standard crossbar alternating along the inner and outer radius ¹⁾	34	E4.42.XXXHB50.R.0	-
2 Extender crossbar on both sides along the inner and outer radius ²⁾	130	E4.42.XXXB50.R.0	H4.42.XXXB50.R.0 ²⁾
3 Extender crossbar along the outer radius ³⁾	85	E4.42.XXXBE50.R.0	H4.42.XXXBE50.R.0 ²⁾
4 Extender crossbar along the inner radius ²⁾	85	E4.42.XXXBZ50.R.0	H4.42.XXXBZ50.R.0 ²⁾
5 Extender crossbar and standard crossbar alternating along the outer radius ³⁾	34	E4.42.XXXHBE50.R.0	-
6 Extender crossbar and standard crossbar alternating along inner radius ¹⁾	34	E4.42.XXXHBZ50.R.0	-

1) Minimum bend radius: R 125 2) Minimum bend radius: R 150 3) Minimum bend radius: R 075

Bi [mm] Available inner widths

| 100 | 125 | 137 | 150 | 162 | 175 | 187 | 200 | 212 | 225 | 237 | 250 |
| 262 | 275 | 287 | 300 | 312 | 325 | 337 | 350 | 362 | 375 | 387 | 400 |

Complete Part No. with the width index **XXX Bi** and the minimum bend radius (**R**). Example:

E4.42.100B50.150.0 = crossbars every link, extender crossbar on both sides along the inner and outer radius



The E4.1 can be fitted with openable extender crossbars, which increase the size of the interior of the e-chain®. Crossbars can be fitted in various ways: from one or both sides, alternating with standard crossbars and or any combination

Extender crossbar with fixed width

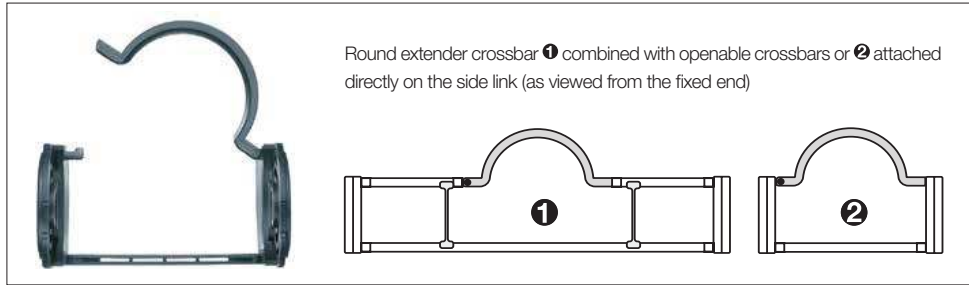

Extender crossbars with fixed width | Safe guiding for large hoses

- Suitable for hoses with a maximum outer diameter of 105mm.
- Variant ① extender crossbar with fixed width to combine with standard crossbars
- Variant ② extender crossbar with fixed width attached directly on the side link
- Optionally openable along the inner "Z" or outer "E" radius
- Gliding with crossbars assembled along the outer radius and a special guide trough

Part No. extender crossbar with fixed width, as individual parts	Hose $\varnothing \leq$ [mm]	Extender crossbar shape	② Fitted to side link	① Combine with openable crossbars
385.15RHD115	105	○ round	No	Yes
385.18RD115	105	○ round	Yes	No

Order example: ① combined with openable crossbars

To receive extender crossbar RHD115 pre-fitted along the outer radius of the-chain®, please add index **E**: E4.42.10/15RHD**E**115/10.**R.0**

To receive extender crossbar RHD115 pre-fitted along the inner radius of the-chain®, please add index **Z**: E4.42.10/15RHD**Z**115/10.**R.0**

Order example: ② fitted to side link

To receive extender crossbar RD115 pre-fitted along the outer radius of the-chain®, please add index **E**: E4.42.18RDE**E**115.**R.0**

To receive extender crossbar RD115 pre-fitted along the inner radius of the-chain®, please add index **Z**: E4.42.18RD**Z**115.**R.0**

Extension links | Hinged crossbars | Swivel clip

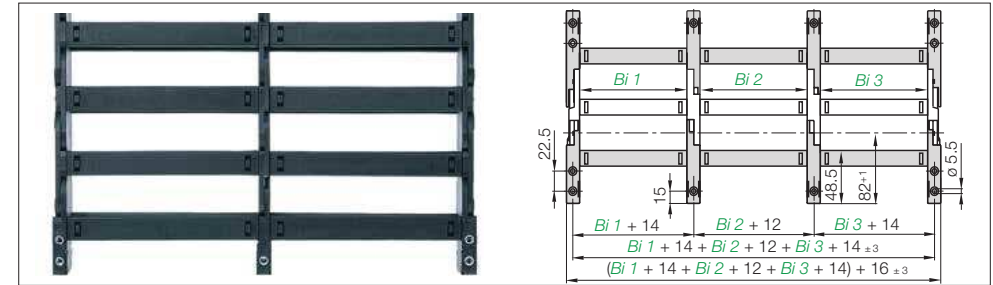

Extension links | For extremely wide e-chains® up to 3.0m

- Virtually unlimited side-by-side extension
- For extremely wide e-chains® up to 3,000mm
- Unsupported length FL_G max. can be increased when heavy fill weights are required
- e-chains® and e-tubes can be combined
- Attached with KMA or steel mounting brackets

Part No. Extension link e-chain®	Part No. Extension link e-tube	Part No. Extension link as an individual part
E4.42. Bi 1/ Bi 2/ Bi 3. R.0	R4.42. Bi 1/ Bi 2/ Bi 3. R.0	384. R.

Complete Part No. with the width index **Bi**1/**Bi**2/**Bi**3/*etc.* and the radius (**R**). Example: E4.42.10/20/10.200.0

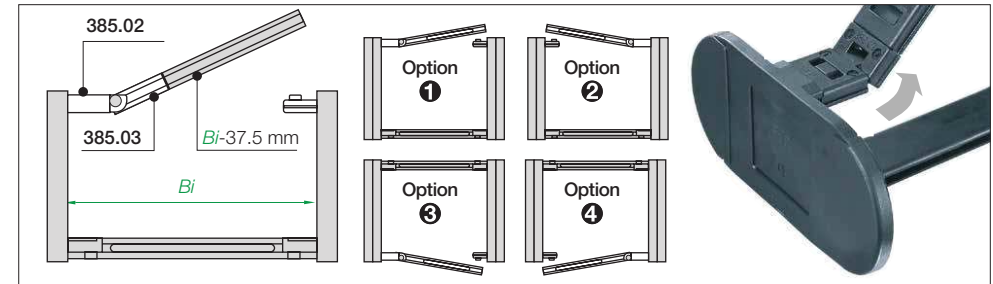

Hinged crossbars | Swivel clip | Openable crossbar remains attached to the e-chain®

- When opening crossbars must remain attached to the e-chain®
- Hinged crossbars consist of a swivel clip and a shortened crossbar
- Openable crossbar (shortened): **Bi**-37.5mm (smallest inner width **Bi** = 87.5)
- Please consult igus® for assistance with this product

Part No. e-chain® with hinged crossbar	Part No. swivel clip as an individual part	Part No. openable crossbar as an individual part
E4.42. Bi . Z . R.0	385.02	385.03

Complete Part No. with the width index **Bi**, the index **Z** for the required option and the radius (**R**). Example: E4.42.137.1.200.0

Steel support tray for support of the lower run

- Simple one-piece support trays for the lower run
- To your requirements and specification
- 4 options available

More information ► [From page 1264](#)

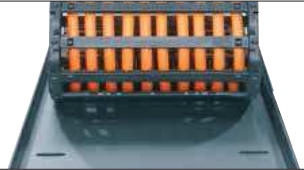
**Swarf up to +850°C**

- e-tubes to withstand 850°C swarf, as a special option
- No hot swarf melting or embedding into the chain
- igus® igumid HT material

More information ► www.igus.co.uk/HT

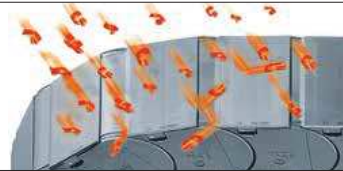
**Reduce assembly time - E4 e-chain® opener**

- e-chain® opener tools for easy opening and closing of e-chains®
- Simple opening and closing of e-chain® crossbars
- Also for use in hard to reach locations
- Significant assembly time reduction

More information ► www.igus.co.uk/E4savetime

**Roller crossbars - increase the service life of cables and hoses**

- Significantly reduce jacket abrasion of very stiff cables and hoses with rolling contact surfaces equipped with tribo-optimised bearings
- For sensitive hoses in restricted space
- Usable along the inner and/or outer radius, retrofit possible

More information ► www.igus.co.uk/roller-crossbar



igus® e-chains® can even withstand the difficult conditions in stone processing facilities. The task of this e-chain® is to supply the tool carriage with energy (up to 100 A), signals, compressed air and water. It can travel up to 12m and achieves speeds of up to 32m/min.