

E4.1 | Series E4.80·H4.80·R4.80 | Product range

Stable due to undercut design, new very large inner height



e-chains® Series E4.80 Crossbars every link (crossbars removable along the inner and outer radius)
 e-chains® Series H4.80 Crossbars every 2nd link (crossbars removable along the inner and outer radius)
 e-tubes Series R4.80 Fully enclosed (lids openable along the outer radius, from one side)

Part No.	Bi	Ba	E4.80	H4.80	R4.80	Part No.	Bi	Ba	E4.80	H4.80	R4.80		
e-chains® / e-tubes	[mm]	[mm]	[kg/m]	[kg/m]	[kg/m]	e-chains® / e-tubes	[mm]	[mm]	[kg/m]	[kg/m]	[kg/m]		
E4. H4. -	80. 05. R.0	50	100	≈ 5.73	≈ 5.72	-	E4. H4. -	80. 28. R.0	287	338	≈ 7.14	≈ 6.42	-
E4. H4. -	80. 055. R.0	55	105	≈ 5.77	≈ 5.74	-	E4. H4. -	80. 31. R.0	312	363	≈ 7.30	≈ 6.50	-
E4. H4. -	80. 06. R.0	65	115	≈ 5.80	≈ 5.76	-	E4. H4. -	80. 32. R.0	325	375	≈ 7.38	≈ 6.54	-
E4. H4. R4.	80. 07. R.0	75	125	≈ 5.86	≈ 5.78	-	E4. H4. -	80. 33. R.0	337	388	≈ 7.48	≈ 6.59	-
E4. H4. -	80. 08. R.0	87	137	≈ 5.93	≈ 5.82	-	E4. H4. R4.	80. 35. R.0	350	400	≈ 7.59	≈ 6.65	≈ 9.90
E4. H4. R4.	80. 10. R.0	100	150	≈ 6.00	≈ 5.85	≈ 6.70	E4. H4. -	80. 36. R.0	362	413	≈ 7.61	≈ 6.66	-
E4. H4. -	80. 11. R.0	112	163	≈ 6.10	≈ 5.90	-	E4. H4. -	80. 37. R.0	375	425	≈ 7.71	≈ 6.71	-
E4. H4. R4.	80. 12. R.0	125	175	≈ 6.16	≈ 5.93	-	E4. H4. -	80. 38. R.0	387	438	≈ 7.74	≈ 6.73	-
E4. H4. -	80. 13. R.0	137	188	≈ 6.27	≈ 5.99	-	E4. H4. R4.	80. 40. R.0	400	450	≈ 7.84	≈ 6.77	≈ 10.52
E4. H4. R4.	80. 15. R.0	150	200	≈ 6.30	≈ 6.01	≈ 7.34	E4. H4. -	80. 41. R.0	412	463	≈ 7.90	≈ 6.80	-
E4. H4. -	80. 16. R.0	162	213	≈ 6.39	≈ 6.05	-	E4. H4. -	80. 42. R.0	425	475	≈ 8.00	≈ 6.85	-
E4. H4. -	80. 169. R.0	169	220	≈ 6.46	≈ 6.08	-	E4. H4. -	80. 43. R.0	437	488	≈ 8.07	≈ 6.89	-
E4. H4. R4.	80. 17. R.0	175	225	≈ 6.50	≈ 6.11	-	E4. H4. -	80. 45. R.0	450	500	≈ 8.23	≈ 6.97	-
E4. H4. -	80. 182. R.0	182	233	≈ 6.54	≈ 6.12	-	E4. H4. R4.	80. 46. R.0	462	513	≈ 8.26	≈ 6.99	≈ 11.33
E4. H4. -	80. 18. R.0	187	238	≈ 6.59	≈ 6.15	-	E4. H4. -	80. 47. R.0	475	525	≈ 8.29	≈ 7.00	-
E4. H4. R4.	80. 20. R.0	200	250	≈ 6.64	≈ 6.17	≈ 8.09	E4. H4. -	80. 48. R.0	487	538	≈ 8.35	≈ 7.03	-
E4. H4. -	80. 207. R.0	207	258	≈ 6.68	≈ 6.20	-	E4. H4. -	80. 50. R.0	500	550	≈ 8.48	≈ 7.09	-
E4. H4. -	80. 21. R.0	212	263	≈ 6.70	≈ 6.20	-	E4. H4. -	80. 51. R.0	512	563	≈ 8.52	≈ 7.11	-
E4. H4. -	80. 22. R.0	225	275	≈ 6.76	≈ 6.23	-	E4. H4. -	80. 52. R.0	525	575	≈ 8.63	≈ 7.17	-
E4. H4. -	80. 23. R.0	237	288	≈ 6.84	≈ 6.28	-	E4. H4. -	80. 53. R.0	537	588	≈ 8.70	≈ 7.21	-
E4. H4. R4.	80. 25. R.0	250	300	≈ 6.94	≈ 6.32	≈ 8.47	E4. H4. -	80. 55. R.0	550	600	≈ 9.05	≈ 7.38	-
E4. H4. -	80. 26. R.0	262	313	≈ 7.01	≈ 6.36	-	E4. H4. -	80. 60. R.0	600	650	≈ 9.23	≈ 7.47	-
E4. H4. R4.	80. 27. R.0	275	325	≈ 7.09	≈ 6.40	-							

1) ▲ ESD version available from stock *Radius not available for e-tubes

Available bend radii

R [mm] | 150* | 200 | 250 | 300 | 350 | 400 | 500 | 550 | 600 | 1.000 |

Complete Part No. with required radius (R). Example:

E4.80.30.300.0 = crossbars every link / H4.80.30.300.0 = crossbars every 2nd link / R4.80.30.300.0 = fully enclosed

ESD - many sizes from stock

- Standardised product made from igumid ESD
 - ESD material tested with over 10 million cycles for the toughest requirements
 - Short delivery times including mounting brackets and interior separation; 24hrs, from stock
- More information ► www.igus.co.uk/esd



E4.1 | E4.80·H4.80·R4.80 | Installation dimensions

Unsupported applications | Short travels

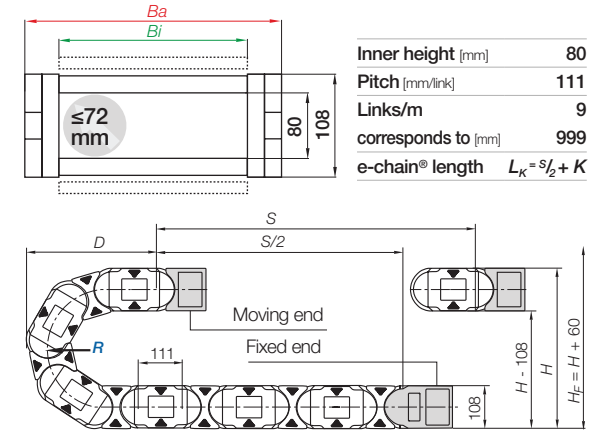
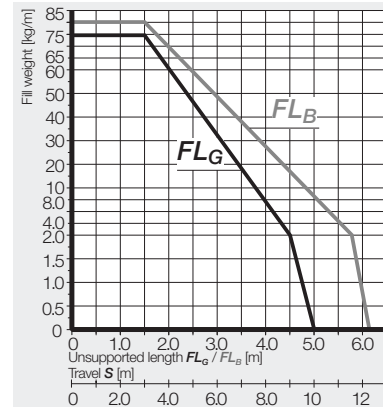

R	150*	200	250	300	350	400	500	550	600	1.000
H ₀₋₂₅	408	508	608	708	808	908	1,108	1,208	1,308	2,108
D	371	421	471	521	571	621	721	771	821	1,221
K	695	855	1,010	1,165	1,325	1,480	1,795	1,950	2,110	3,365

The required clearance height: $H_F = H + 60\text{mm}$ (with 3.0kg/m fill weight)

*Radius not available for e-tubes

Gliding applications | For long travels from 12m to max. 400m

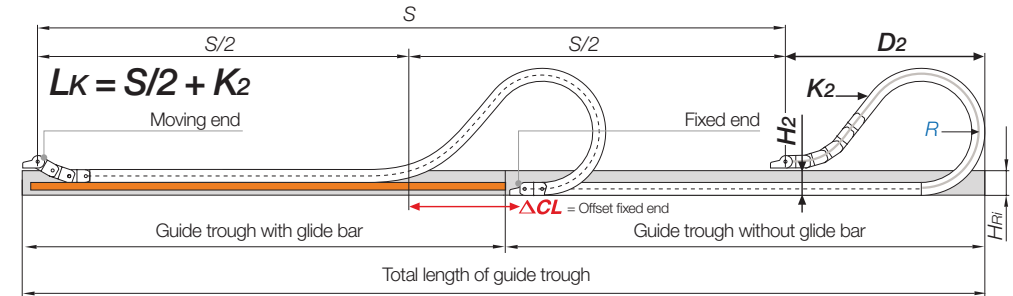

Note: We recommend the project planning of such a system to be carried out by igus®.

In case of travels between 10 and 12m we recommend an e-chain® with a longer unsupported length.

R	150*	200	250	300	350	400	500	550	600	1.000
H ₂	242	242	242	242	242	242	242	-	-	-
D ₂ *25	550	800	1,000	1,200	1,450	1,600	2,100	-	-	-
K ₂	890	1,330	1,665	2,000	2,330	2,660	3,440	-	-	-
ΔCL	189	389	539	689	889	989	1,389	-	-	-

*Radius not available for e-tubes

E4.1 | e-chains® E4.80·H4.80 | Accessories

KMA mounting brackets | Attachment from any side | Pivoting | Locking

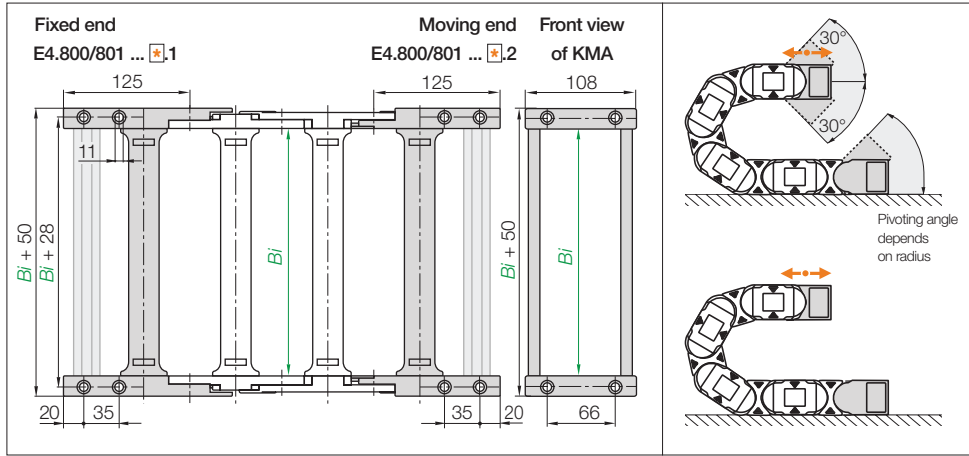

KMA pivoting | Recommended for unsupported and gliding applications
KMA locking | Recommended for vertical hanging and standing applications

Width index	Part No. full set KMA pivoting	Part No. full set KMA locking	Bi [mm]	Width index	Part No. full set KMA pivoting	Part No. full set KMA locking	Bi [mm]
05.	E4.800.05	E4.801.05	50	28.	E4.800.28	E4.801.28	287
055.	E4.800.055	E4.801.055	55	30.	E4.800.30	E4.801.30	300
06.	E4.800.06	E4.801.06	65	31.	E4.800.31	E4.801.31	312
07.	E4.800.07	E4.801.07	75	32.	E4.800.32	E4.801.32	325
08.	E4.800.08	E4.801.08	87	33.	E4.800.33	E4.801.33	337
10.	E4.800.10	E4.801.10	100	35.	E4.800.35	E4.801.35	350
11.	E4.800.11	E4.801.11	112	36.	E4.800.36	E4.801.36	362
12.	E4.800.12	E4.801.12	125	37.	E4.800.37	E4.801.37	375
13.	E4.800.13	E4.801.13	137	38.	E4.800.38	E4.801.38	387
15.	E4.800.15	E4.801.15	150	40.	E4.800.40	E4.801.40	400
16.	E4.800.16	E4.801.16	162	41.	E4.800.41	E4.801.41	412
169.	E4.800.169	E4.801.169	169	42.	E4.800.42	E4.801.42	425
17.	E4.800.17	E4.801.17	175	43.	E4.800.43	E4.801.43	437
182.	E4.800.182	E4.801.182	182	45.	E4.800.45	E4.801.45	450
18.	E4.800.18	E4.801.18	187	46.	E4.800.46	E4.801.46	462
20.	E4.800.20	E4.801.20	200	47.	E4.800.47	E4.801.47	475
207.	E4.800.207	E4.801.207	207	48.	E4.800.48	E4.801.48	487
21.	E4.800.21	E4.801.21	212	50.	E4.800.50	E4.801.50	500
22.	E4.800.22	E4.801.22	225	51.	E4.800.51	E4.801.51	512
23.	E4.800.23	E4.801.23	237	52.	E4.800.52	E4.801.52	525
25.	E4.800.25	E4.801.25	250	53.	E4.800.53	E4.801.53	537
26.	E4.800.26	E4.801.26	262	55.	E4.800.55	E4.801.55	550
27.	E4.800.27	E4.801.27	275	60.	E4.800.60	E4.801.60	600

(KMA = polymer metal mounting bracket) For the C-profile option please add index .C

E4.1 | e-tubes R4.80 | Accessories

KMA mounting brackets | Attachment from any side | Pivoting | Locking

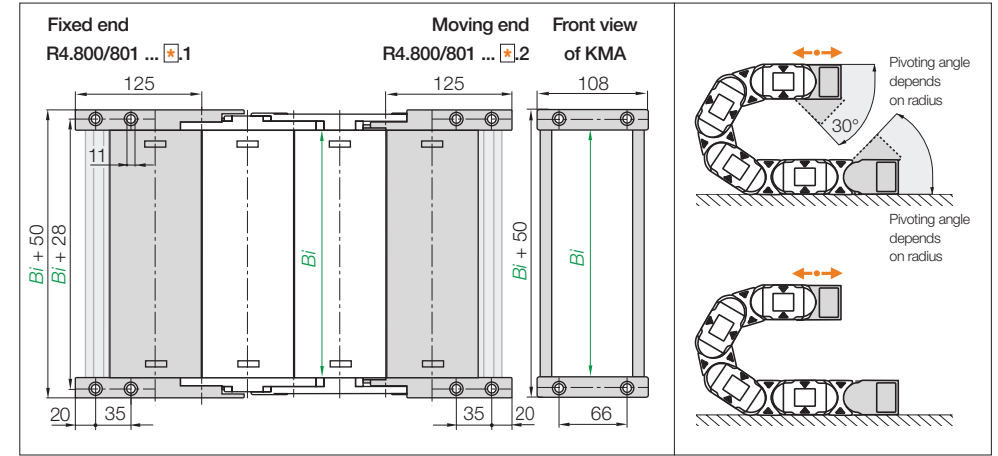

KMA pivoting | Recommended for unsupported and gliding applications
KMA locking | Recommended for vertical hanging and standing applications

Width index	Part No. full set KMA pivoting	Part No. full set KMA locking	Bi [mm]	Width index	Part No. full set KMA pivoting	Part No. full set KMA locking	Bi [mm]
10.	R4.800.10	R4.801.10	100	30.	R4.800.30	R4.801.30	300
15.	R4.800.15	R4.801.15	150	35.	R4.800.35	R4.801.35	350
20.	R4.800.20	R4.801.20	200	40.	R4.800.40	R4.801.40	400
25.	R4.800.25	R4.801.25	250	46.	R4.800.46	R4.801.46	462

(KMA = polymer metal mounting bracket) For the C-profile option please add index .C

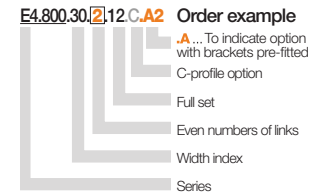
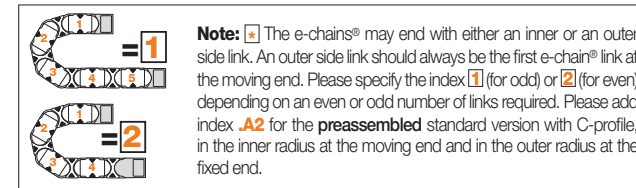

Strain relief e.g. clamps, tiewrap plates, nuggets and plug-in clips are available from stock. The complete chainfix range with ordering options ▶ From page 1300

Interior separation | Increase cable service life

Previous generation of interior separation with other options ► www.igus.co.uk/E4.80

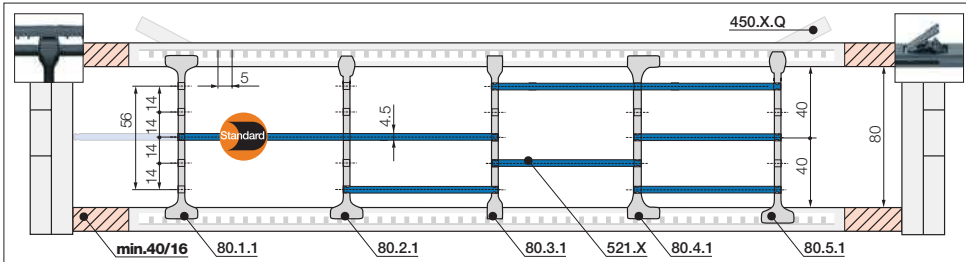

Note: Please be aware of the minimum lateral gap to the side links! **e-tube: 40mm** | **e-chain®: 16mm**
As standard separators are fitted every 2nd e-chain® link!

		4		Standard separator, wide base
		18		unassembled 80.1 assembled 80.1.1

Standard - for any application
Separator with a wide base for maximum holding force in the e-chain®.

		8		Separator for QuickLock crossbar
		18		unassembled 80.2 assembled 80.2.1

For even faster installation
Separator for igus® QuickLock crossbar 450.X.Q. Wide on one side for high holding force, narrow on opposite side for easy cable fitting.

		4		Separator, narrow
		8		unassembled 80.3 assembled 80.3.1

For small cables
Separator with a narrow base for a large number of small cables side by side. Saves space in the e-chain®. Also available for QuickLock crossbars.

		4		Separator, asymmetrical
		18		unassembled 80.4 assembled 80.4.1

For side-mounted applications
Asymmetrical separator, for defined gap distance. No additional spacers required.

		8		Notch separator for notched crossbar
		18		unassembled 80.5 assembled 80.5.1

Locks securely in preset increments
Notch separator for exact positioning in e-chains®. Recommended for side-mounted applications.

		52		Shelf, lockable
		X-1		unassembled 520.X assembled 521.X

Horizontal separation
Full-width shelf locks securely into separators at both ends, giving a fixed width. Can be used as full-width or partial shelf.

Shelves Width = X [mm]	X [mm]	unassembled	assembled	X [mm]	unassembled	assembled	X [mm]	unassembled	assembled
		050	520.050	521.050	150	520.150	521.150	300	520.300
	065	520.065	521.065	175	520.175	521.175	350	520.350	521.350
	075	520.075	521.075	200	520.200	521.200	375	520.375	521.375
	100	520.100	521.100	225	520.225	521.225	387	520.387	521.387
	125	520.125	521.125	250	520.250	521.250	450	520.450	521.450

Interior separation | To allow faster filling

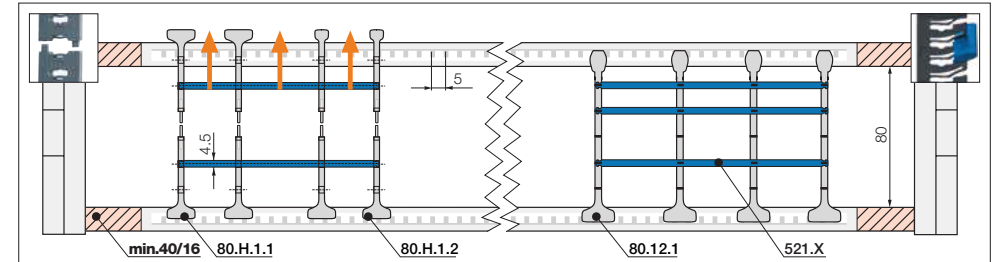

Note: Please be aware of the minimum lateral gap to the side links! **e-tube: 40mm** | **e-chain®: 16mm**
As standard separators are fitted every 2nd e-chain® link!

		4		Split separator, wide base/top
		18		unassembled 80.H.1 assembled 80.H.1.1

Split separators
In order to fill e-chains® more easily and effectively, these separators can be split in the middle. This allows easier access to middle shelf partitions. Fast assembly and easy retrofit. 2 types available: with wide or narrow top.

		8		Split separator, narrow top
		18		unassembled 80.H.2 assembled 80.H.2.1

		8		Lean separator
		18		unassembled 80.12 assembled 80.12.1

Lean separators New
New design allows extremely fast fitting of shelves in several layers, which significantly reduces assembly time. Enables extremely fast replacement of individual cables in a very full e-chain®.

Lean separator design - several layers of cables fitted quickly, save up to 50%* assembly time
(*Lean separator vs. standard separator - measured on a 4m long e-chain® fitted with 12 cables in the igus® readychain® factory)



More interior separation options

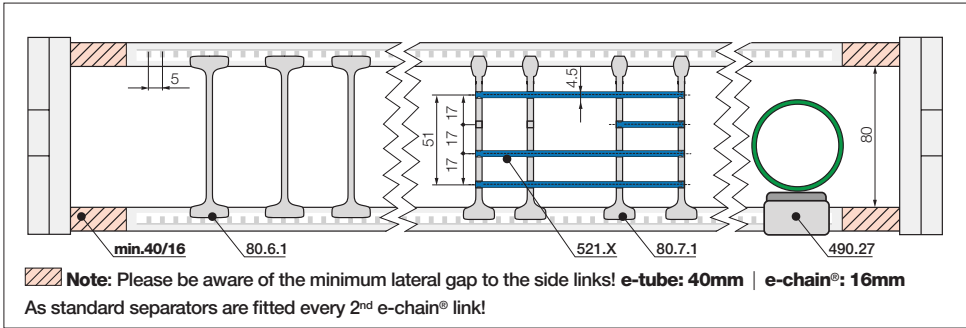

		Notch locking separator	unassembled 80.6 assembled 80.6.1
		Separator, one end locking	unassembled 80.7 assembled 80.7.1
		Rollclip* for e-chains®	unassembled 489.27 assembled 490.27

Notch locking separator for increased holding force
Notch locking separators offer higher crossbar opening forces for high humidity and/or large hydraulic hoses. They can be positioned precisely and then locked in position.

Separator, one end locking
Offset slots for more variability

Rollclip*
Minimises abrasion of sensitive hoses. Simply clamps onto the opening crossbar. The movable rollers compensate for relative movement between the e-chain® and hose.

*Only for e-chains®

TUB New

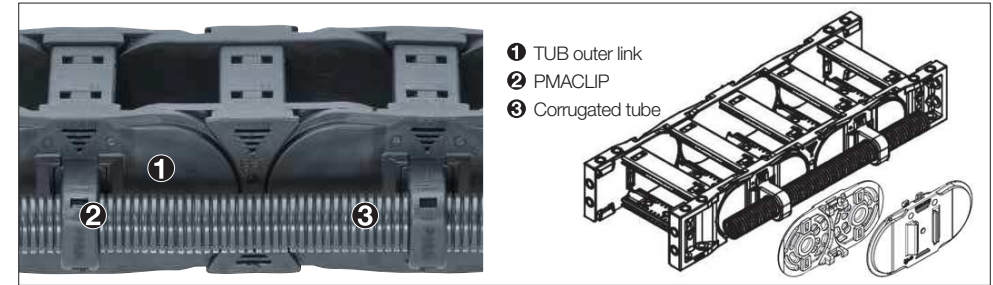

TUB | Safe guidance for corrugated tubes parallel to the e-chain®

- Additional, simple guidance for corrugated tubes on the outside of the e-chain®
- PMACLIP allows corrugated tubes with nominal widths 17, 23, 29, 36, 48mm to be easily clipped on
- Easy access to the corrugated tubes, fast replacement of the hoses
- Reduce assembly time and cost - easy to assemble, without any additional screws or tools
- The part number includes the e-chain® with TUB side sections; the PMACLIP support and the hose are ordered separate

Part No. TUB Outer link right*	Part No. TUB Outer link left*	Part No. TUB Outer link at both ends*	For corrugated tube nominal diameter Ø [mm]
E4.80.XXXTUBR.R.0	E4.80.XXXTUBL.R.0	E4.80.XXXTUB.R.0	17 / 23 / 29 / 36 / 48

*As viewed from the fixed end

Part number appended with width index **XXX Bi** and radius **(R)** e.g.

E4.80.100TUBR.150.0 = with TUB outer sections every 2nd right hand link

Product range | PMACLIP | Support, one-piece, with safety clip

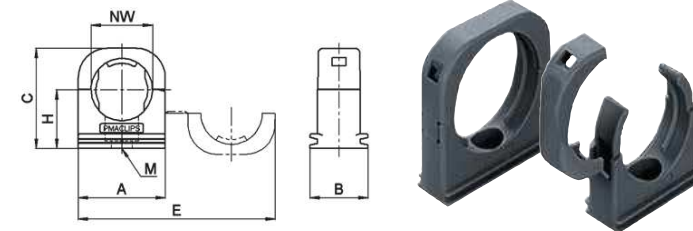

PMACLIP support - one-piece construction with safety clip, suitable for corrugated tubes

Part No.	NW	A	B	C	H	E	M
PMACLIP	Ø [mm]	mm	mm	mm	mm	mm	mm
I-BFH-17-0	17	30.0	20.0	34.0	20.0	68.0	M6
I-BFH-23-0	23	38.5	20.0	42.0	24.0	85.0	M6
I-BFH-29-0	29	45.5	20.0	48.0	27.0	99.0	M6
I-BFH-36-0	36	55.5	20.0	56.0	31.0	119.0	M6
I-BFH-48-0	48	67.5	20.0	68.0	37.0	143.0	M6

Extender crossbar with fixed width

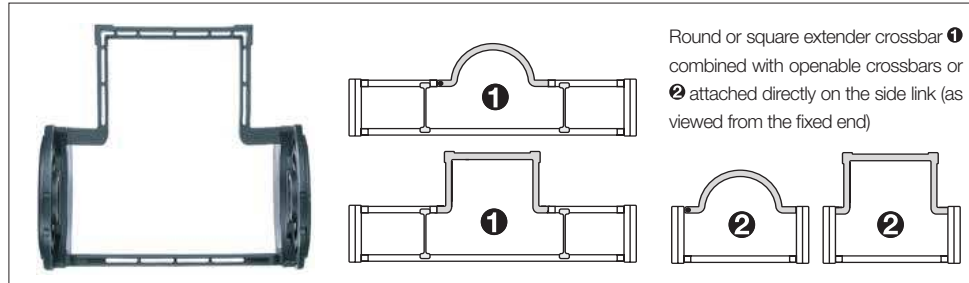

Extender crossbars with fixed width | Safe guiding for large hoses

- Suitable for hoses with a maximum outer diameter of 270mm
- Variant 1 extender crossbar with fixed width to combine with standard crossbars
- Variant 2 extender crossbar with fixed width attached directly on the side link
- Optionally openable along the inner "Z" or outer "E" radius
- Gliding with crossbars assembled along the outer radius and a special guide trough

Part No. extender crossbar with fixed width, as individual parts	Hose $\varnothing \leq$ [mm]	Extender crossbar shape	2 Fitted to side link	1 Combine with openable crossbars
450.15RHD115	115	○ round	No	Yes
450.17RD115	115	○ round	Yes	No
450.25D150	150	□ square	Yes	No
450.30D200	200	□ square	Yes	No
450.35D250	220	□ square	Yes	No
450.40D300	270	□ square	Yes	No
450.20HD150	150	□ square	No	Yes
450.25HD200	200	□ square	No	Yes
450.30HD250	220	□ square	No	Yes

Order example: 1 combined with openable crossbars

To receive extender crossbar RHD115 pre-fitted along the outer radius of the-chain®, please add index **E: E4.80.10/15RHD**E115/10.**R.0**

To receive extender crossbar RHD115 pre-fitted along the inner radius of the-chain®, please add index **Z: E4.80.10/15RHD**Z115/10.**R.0**

Order example: 2 fitted to side link

To receive extender crossbar RD115 pre-fitted along the outer radius of the-chain®, please add index **E: E4.80.17RDE**E115.**R.0**

To receive extender crossbar RD115 pre-fitted along the inner radius of the-chain®, please add index **Z: E4.80.17RD**Z115.**R.0**

Extension links

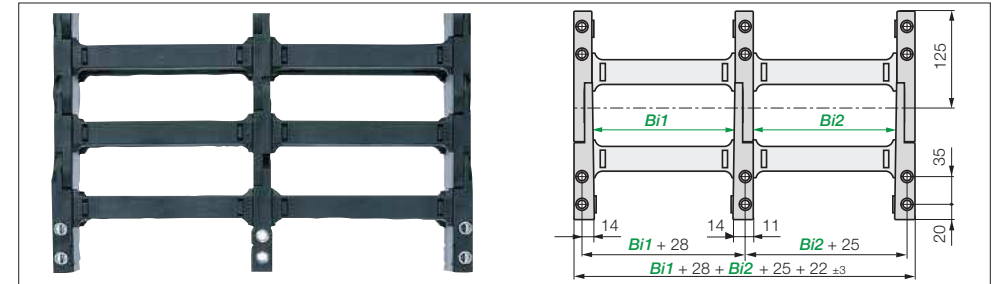

Extension links | For extremely wide e-chains® up to 3.0m

- Virtually unlimited side-by-side extension
- For extremely wide e-chains® up to 3,000mm
- Unsupported length FL_G max. can be increased when heavy fill weights are required
- e-chains® and e-tubes can be combined
- Attached with KMA or steel mounting brackets

Part No. Extension link e-chain®	Part No. Extension link e-tube	Part No. extension link as an individual part	
		Outer link	Inner link
E4.80. Bi1/Bi2/Bi3 .R.0	R4.80. Bi1/Bi2/Bi3 .R.0	E4.80M.01	E4.80M.02.R.

Complete Part No. with the width index **Bi1/Bi2/Bi3/etc.** and the radius (**R**). Example: **E4.80.10/20/10.200.0**

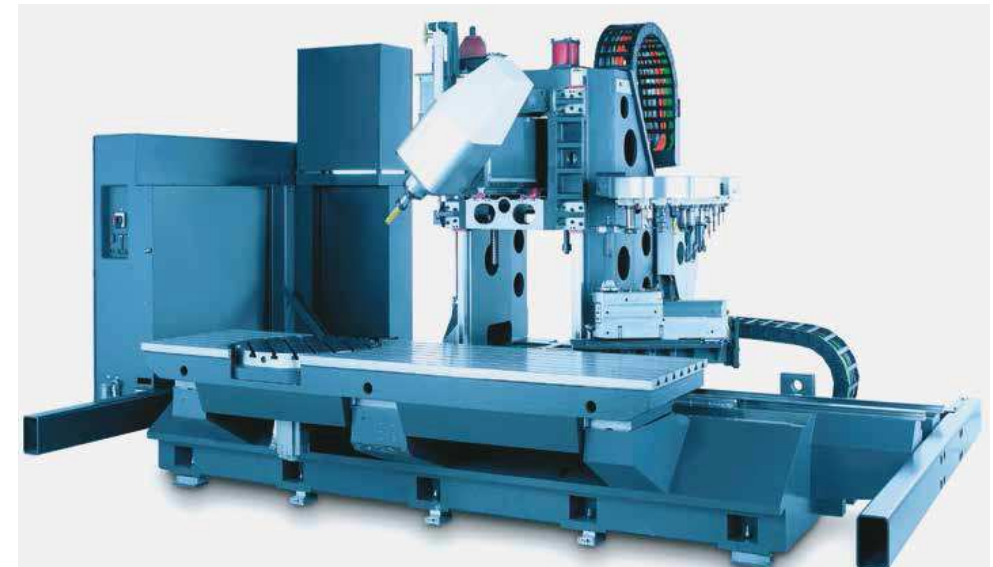

Due to the undercut design igus® E4.1 series feature high lateral stability. High lateral accelerations of up to $8m/s^2$ can be managed on this milling machine for bicycles

E4 snapclip - clip-on tiewrap

- For side-mounted applications, compatible with many E4 e-chains®
- Serves as a clip-on, lateral guide for hoses and cables on e-chains®
- The loops can be adjusted as required

More information ► www.igus.co.uk/E4.80

**Steel support tray for support of the lower run**

- Simple one-piece support trays for the lower run
- To your requirements and specification
- 4 options available

More information ► From page 1264

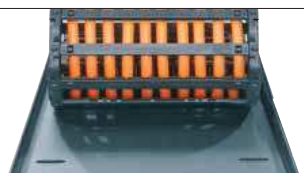
**Swarf up to +850°C**

- e-tubes to withstand 850°C swarf, as a special option
- No hot swarf melting or embedding into the chain
- igus® igumid HT material

More information ► www.igus.co.uk/HT

**Reduce assembly time - E4 e-chain® opener**

- e-chain® opener tools for easy opening and closing of e-chains®
- Simple opening and closing of e-chain® crossbars
- Also for use in hard to reach locations
- Significant assembly time reduction

More information ► www.igus.co.uk/E4savetime

**Heavy-duty version - for very long travels or heavy fill weights**

- High torsional rigidity and tensile strength
- Robust steel mounting brackets
- For long-term operation in very humid environments

Series 5050HD-R9850HD. More information ► www.igus.co.uk/5050HD

**Roller crossbars - increase the service life of cables and hoses**

- Significantly reduce jacket abrasion of very stiff cables and hoses with rolling contact surfaces equipped with tribo-optimised bearings
- For sensitive hoses in restricted space
- Usable along the inner and/or outer radius, retrofit possible

More information ► www.igus.co.uk/roller-crossbar



igus® E4.1 in an earth drilling machine. This vertically standing installation works even under strong vibration and harsh environments due to its plastic construction and having no loose parts such as rivets or screws