



Standard ... E4.48L

... R4.48L

e-chains® | E4.48L | Crossbars every link (openable along inner and outer radius, from both sides)
e-tubes | R4.48L | Fully enclosed (lids openable along inner and outer radius, from both sides)

Part No.	Part No.	Bi	Ba	E4.48L	R4.48L	Part No.	Part No.	Bi	Ba	E4.48L	R4.48L
e-chains®	e-tubes	[mm]	[mm]	[kg/m]	[kg/m]	e-chains®	e-tubes	[mm]	[mm]	[kg/m]	[kg/m]
E4.48L.050.R.0	R4.48L.050.R.0	050	070	≈ 1.53	≈ 1.64	R4.48L.225.R.0	-	225	245	≈ 2.24	-
E4.48L.062.R.0	R4.48L.062.R.0	062	082	≈ 1.58	≈ 1.69	R4.48L.237.R.0	-	237	257	≈ 2.30	-
E4.48L.075.R.0	R4.48L.075.R.0	075	095	≈ 1.64	≈ 1.82	E4.48L.250.R.0	R4.48L.250.R.0	250	270	≈ 2.35	≈ 3.08
E4.48L.087.R.0	R4.48L.087.R.0**	087	107	≈ 1.67	≈ 1.91	E4.48L.262.R.0	-	262	282	≈ 2.39	-
E4.48L.100.R.0	R4.48L.100.R.0	100	120	≈ 1.73	≈ 2.01	E4.48L.275.R.0**	-	275	295	≈ 2.45	-
E4.48L.105.R.0	-	105	125	≈ 1.74	-	E4.48L.287.R.0**	-	287	307	≈ 2.51	-
E4.48L.112.R.0	-	112	132	≈ 1.79	-	E4.48L.300.R.0	R4.48L.300.R.0**	300	320	≈ 2.56	≈ 3.42
E4.48L.125.R.0	R4.48L.125.R.0	125	145	≈ 1.84	≈ 2.18	E4.48L.312.R.0**	-	312	332	≈ 2.60	-
E4.48L.137.R.0	-	137	157	≈ 1.88	-	E4.48L.325.R.0**	-	325	345	≈ 2.66	-
E4.48L.150.R.0	R4.48L.150.R.0	150	170	≈ 1.97	≈ 2.36	E4.48L.337.R.0**	-	337	357	≈ 2.72	-
E4.48L.162.R.0	-	162	182	≈ 2.00	-	E4.48L.350.R.0**	-	350	370	≈ 2.74	-
E4.48L.175.R.0	R4.48L.175.R.0	175	195	≈ 2.04	≈ 2.58	E4.48L.362.R.0**	-	362	382	≈ 2.77	-
E4.48L.187.R.0**	-	187	207	≈ 2.09	-	E4.48L.375.R.0**	-	375	395	≈ 2.81	-
E4.48L.200.R.0	R4.48L.200.R.0	200	220	≈ 2.14	≈ 2.70	E4.48L.387.R.0**	-	387	407	≈ 2.90	-
E4.48L.212.R.0**	-	212	232	≈ 2.18	-	E4.48L.400.R.0**	-	400	420	≈ 2.96	-

**Width available upon request. Please consult igus® for delivery time.

1) Radius not available for e-tubes

Available bend radii

R [mm] | 075¹⁾ | 100¹⁾ | 125 | 150 | 175 | 200 | 250 | 300 | 350 |

Complete Part No. with required radius (R). Example:

E4.48L.175.150.0 = crossbars every link / R4.48L.175.150.0 = fully enclosed

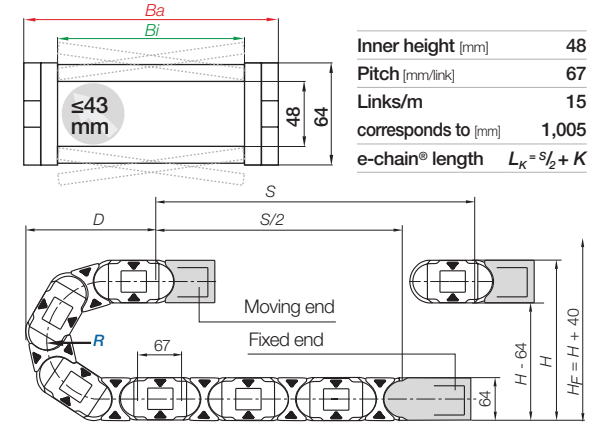
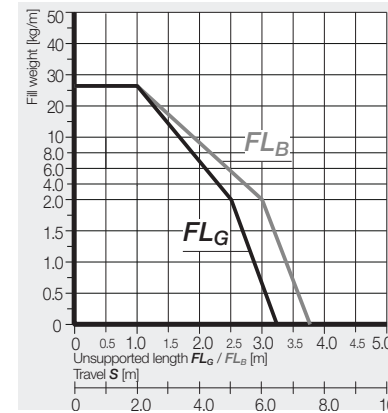

	075 ¹⁾	100 ¹⁾	125	150	175	200	250	300	350
R	075 ¹⁾	100 ¹⁾	125	150	175	200	250	300	350
H	214	264	314	364	414	464	564	664	764
D	208	233	258	283	308	333	383	433	483
K	370	450	530	610	685	765	920	1,080	1,235

The required clearance height: $H_f = H + 40\text{mm}$ (with 2.5kg/m fill weight)

1) Radius not available for e-tubes

Gliding applications | For long travels from 10m to max. 100m

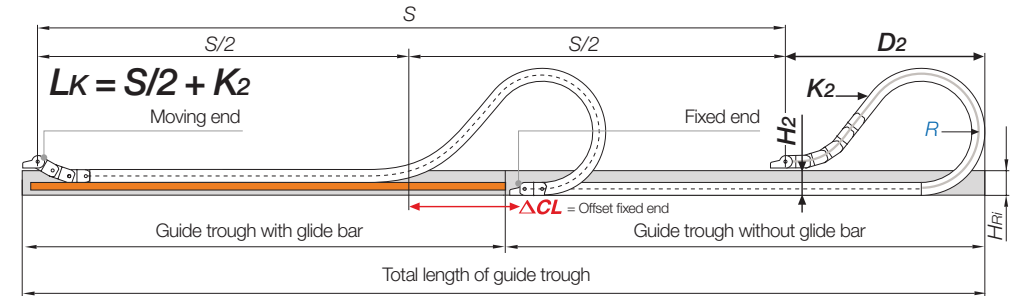

Note: We recommend the project planning of such a system to be carried out by igus®.

In case of travels between 5 and 10m we recommend an e-chain® with a longer unsupported length.

	075 ¹⁾	100 ¹⁾	125	150	175	200	250	300 ²⁾	350 ²⁾
H ₂	214	264	106	106	106	106	106	-	-
D ₂	208	233	475	570	670	780	1,030	-	-
K ₂	370	450	804	938	1,139	1,340	1,675	-	-
ΔCL	-	-	230	300	380	460	660	-	-

1) Radius not available for e-tubes 2) Radius not suitable for long travels. Please consult igus®.

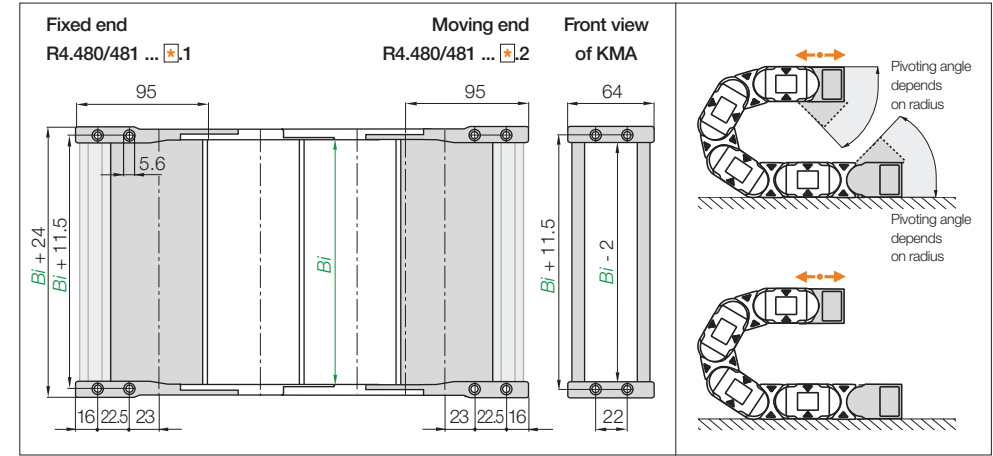
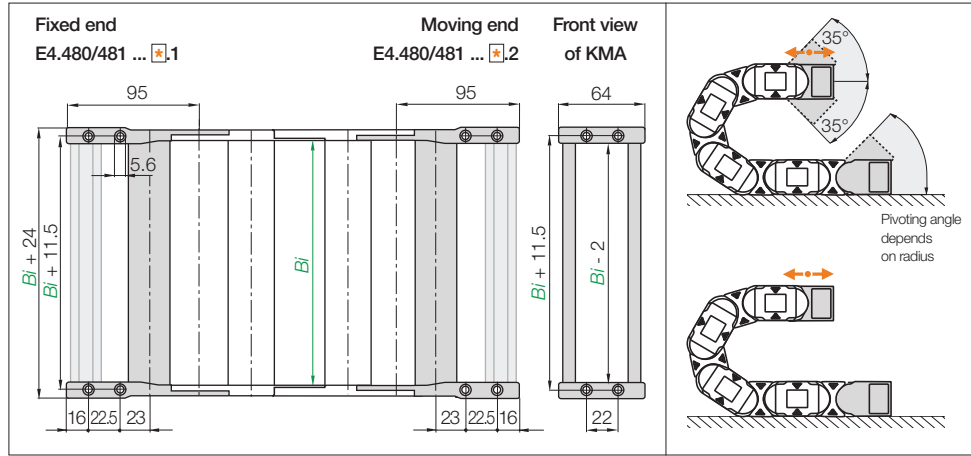

KMA pivoting | Recommended for unsupported and gliding applications
KMA locking | Recommended for vertical hanging and standing applications

Width index	Part No. full set KMA pivoting	Part No. full set KMA locking	Bi [mm]	Width index	Part No. full set KMA pivoting	Part No. full set KMA locking	Bi [mm]
050	E4.480.050.12.C	E4.481.050.12.C	050	225	E4.480.225.12.C	E4.481.225.12.C	225
062	E4.480.062.12.C	E4.481.062.12.C	062	237	E4.480.237.12.C	E4.481.237.12.C	237
075	E4.480.075.12.C	E4.481.075.12.C	075	250	E4.480.250.12.C	E4.481.250.12.C	250
087	E4.480.087.12.C	E4.481.087.12.C	087	262	E4.480.262.12.C	E4.481.262.12.C	262
100	E4.480.100.12.C	E4.481.100.12.C	100	275	E4.480.275.12.C*	E4.481.275.12.C*	275
105	E4.480.105.12.C	E4.481.105.12.C	105	287	E4.480.287.12.C*	E4.481.287.12.C*	287
112	E4.480.112.12.C	E4.481.112.12.C	112	300	E4.480.300.12.C	E4.481.300.12.C	300
125	E4.480.125.12.C	E4.481.125.12.C	125	312	E4.480.312.12.C*	E4.481.312.12.C*	312
137	E4.480.137.12.C	E4.481.137.12.C	137	325	E4.480.325.12.C*	E4.481.325.12.C*	325
150	E4.480.150.12.C	E4.481.150.12.C	150	337	E4.480.337.12.C*	E4.481.337.12.C*	337
162	E4.480.162.12.C	E4.481.162.12.C	162	350	E4.480.350.12.C*	E4.481.350.12.C*	350
175	E4.480.175.12.C	E4.481.175.12.C	175	362	E4.480.362.12.C*	E4.481.362.12.C*	362
187	E4.480.187.12.C*	E4.481.187.12.C*	187	375	E4.480.375.12.C*	E4.481.375.12.C*	375
200	E4.480.200.12.C	E4.481.200.12.C	200	387	E4.480.387.12.C*	E4.481.387.12.C*	387
212	E4.480.212.12.C*	E4.481.212.12.C*	212	400	E4.480.400.12.C*	E4.481.400.12.C*	400

(KMA = polymer metal mounting bracket) For the C-profile option please add index .C
 *Width available upon request. Please consult igus® for delivery time.

KMA pivoting | Recommended for unsupported and gliding applications
KMA locking | Recommended for vertical hanging and standing applications

Width index	Part No. full set KMA pivoting	Part No. full set KMA locking	Bi [mm]	Width index	Part No. full set KMA pivoting	Part No. full set KMA locking	Bi [mm]
050	R4.480.050.12.C	R4.481.050.12.C	050	150	R4.480.150.12.C	R4.481.150.12.C	150
062	R4.480.062.12.C	R4.481.062.12.C	062	175	R4.480.175.12.C	R4.481.175.12.C	175
075	R4.480.075.12.C	R4.481.075.12.C	075	200	R4.480.200.12.C	R4.481.200.12.C	200
087	R4.480.087.12.C*	R4.481.087.12.C*	087	250	R4.480.250.12.C	R4.481.250.12.C	250
100	R4.480.100.12.C	R4.481.100.12.C	100	300	R4.480.300.12.C*	R4.481.300.12.C*	300
125	R4.480.125.12.C	R4.481.125.12.C	125				

(KMA = polymer metal mounting bracket) For the C-profile option please add index .C
 *Width available upon request. Please consult igus® for delivery time.

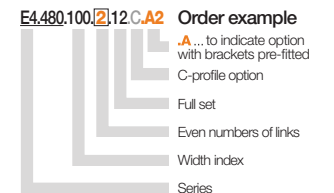
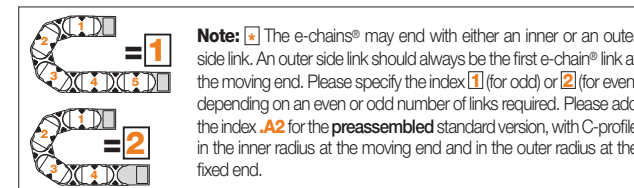

Strain relief e.g. clamps, tiewrap plates, nuggets and plug-in clips are available from stock. The complete chainfix range with ordering options ▶ From page 1300

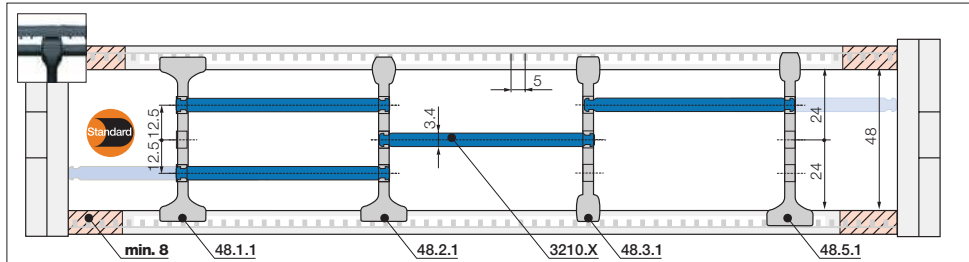

Note: Please be aware of the minimum lateral gap to the side links! **e-tube: 8mm** | **e-chain®: 8mm**
As standard separators are fitted every 2nd e-chain® link!

Standard separator, wide base

unassembled	48.1
assembled	48.1.1

Standard - for any application
Separator with a wide base for maximum holding force in the e-chain®.

Separator, narrow top

unassembled	48.2
assembled	48.2.1

For even faster installation
Wide on one side for high holding force, narrow on opposite side for easy cable fitting.

Separator, narrow

unassembled	48.3
assembled	48.3.1

For small cables
Separator with a narrow base for a large number of small cables side by side. Saves space in the e-chain®.

Notch separator for notched crossbar

unassembled	48.5
assembled	48.5.1

Locks securely in preset increments
Notch separator for exact positioning in e-chains®. Recommended for side-mounted applications.

Shelf, lockable

unassembled	3200.X
assembled	3210.X

Horizontal separation
Full-width shelf locks securely into separators at both ends, giving a fixed width. Can be used as full-width or partial shelf.

Shelves Width = X [mm]	X [mm]		X [mm]		X [mm]			
	unassembled	assembled	unassembled	assembled	unassembled	assembled		
050	3200.050	3210.050	125	3200.125	3210.125	225	3200.225	3210.225
075	3200.075	3210.075	150	3200.150	3210.150	250	3200.250	3210.250
100	3200.100	3210.100	175	3200.175	3210.175			
115	3200.115	3210.115	200	3200.200	3210.200			

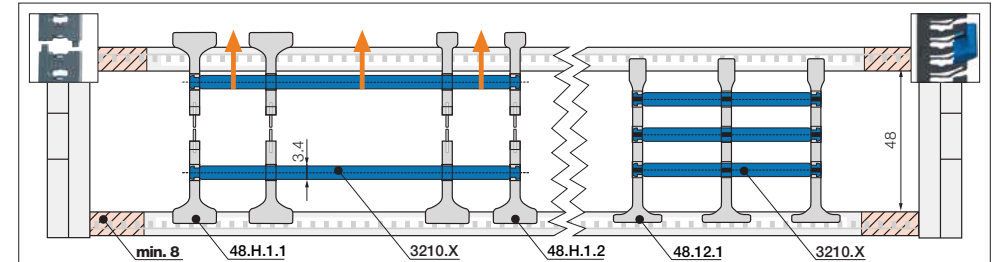

Note: Please be aware of the minimum lateral gap to the side links! **e-tube: 8mm** | **e-chain®: 8mm**
As standard separators are fitted every 2nd e-chain® link!

Split separator, wide base/top

unassembled	48.H.1
assembled	48.H.1.1

Split separators
In order to fill e-chains® more easily and effectively, these separators can be split in the middle. This allows easier access to middle shelf partitions. Fast assembly and easy retrofit. 2 types available: with wide or narrow top.

Split separator, narrow top

unassembled	48.H.2
assembled	48.H.2.1

Lean separator

unassembled	48.12
assembled	48.12.1

Lean separators
New design allows extremely fast fitting of shelves in several layers, which significantly reduces assembly time. Enables extremely fast replacement of individual cables in a very full e-chain®.

Lean separator design - several layers of cables fitted quickly, save up to 50%* assembly time
(*Lean separator vs. standard separator - measured on a 4m long e-chain® fitted with 12 cables in the igus® harnessing factory)



Separator with integrated strain relief teeth

- Can be integrated into the mounting bracket or placed at any point in the e-chain®
- Combines strain relief and interior separation, for restricted space conditions
- Strain relief separator is easy to assemble without any tools

2 versions: Part No. 48.Z / Part No. 48.ZS. More information ► From page 1326

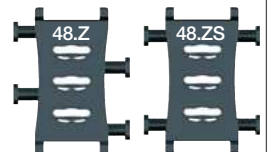

Extension links **New**

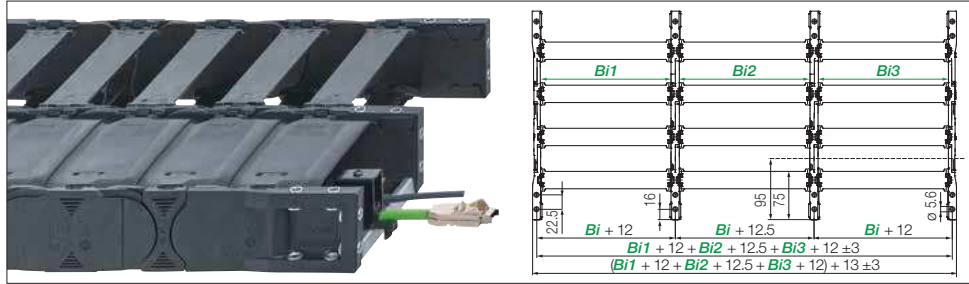

Extension links | For extremely wide e-chains® up to 2.0m with 50% more fill weight

- Extension link e-chains® for 50% higher fill weight extension link up to widths of 2.0m and more
- For heavy fill weights or e-chains® with many heavy cables next to each other
- e-chains® and e-tubes can be combined

Part No.	Part No.	Part No.
Extension link e-chain®	Extension link e-tube	Extension link as an individual part
E4.48L.Bi1/Bi2/Bi3.R.0	R4.48L.Bi1/Bi2/Bi3.R.0	E4.48ML.R.

Complete Part No. with the width index *Bi1/Bi2/Bi3/etc.* and the radius (*R*). Example: E4.48L.175/175/175.150.0

Increase of the fill weight per extension link

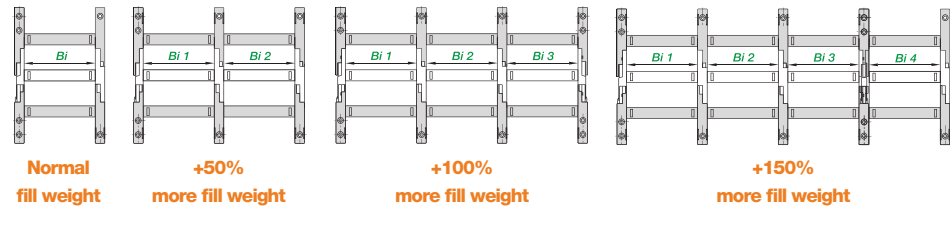

e-chain® with openable extender crossbars

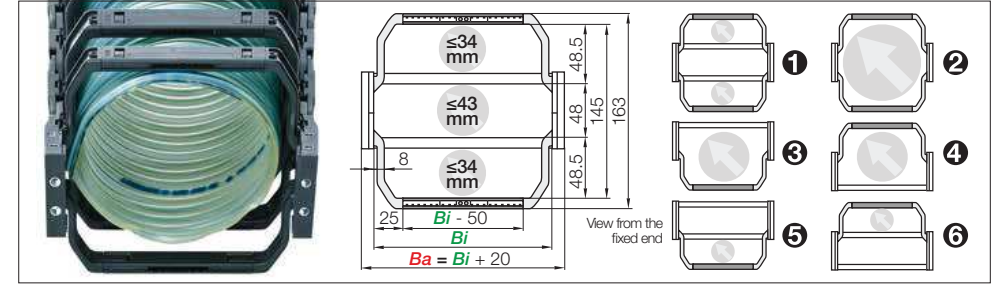

Extender crossbars with flexible width | Safe guiding for large hoses

- For guiding and protecting large hoses
- With mounting for noise dampers
- Cable-friendly design, high crossbar holding force
- The openable extender crossbars can be fitted in different ways and combinations
- Optionally openable along the inner or outer radius

Versions e-chain®	Hose	Part No. e-chain®
with extender crossbar	Ø ≤ [mm]	with extender crossbar
① Extender crossbar and standard crossbar alternating along the inner and outer radius ¹⁾	34	E4.48L.XXXHB48.R.0
② Extender crossbar on both sides along the inner and outer radius ²⁾	130	E4.48L.XXXB48.R.0
③ Extender crossbar along the outer radius ³⁾	85	E4.48L.XXXBE48.R.0
④ Extender crossbar along the inner radius ²⁾	85	E4.48L.XXXBZ48.R.0
⑤ Extender crossbar and standard crossbar alternating along the outer radius ³⁾	34	E4.48L.XXXHBE48.R.0
⑥ Extender crossbar and standard crossbar alternating along inner radius ¹⁾	34	E4.48L.XXXHBZ48.R.0

1) Minimum bend radius: *R 125* 2) Minimum bend radius: *R 150* 3) Minimum bend radius: *R 075* *Width available upon request. Delivery time upon request

Bi [mm] Available inner widths

| 100 | 112 | 125 | 137 | 150 | 162 | 175 | 187 | 200 | 212 | 225 | 237 | 250 | 262 | 275 | 287 | 300 | 312 | 325 | 337 | 350 |

Complete Part No. with the width index *XXX Bi* and the radius (*R*). Example:

E4.48L.100B48.150.0 = extender crossbar on both sides along inner and outer radius



The E4.1L can be fitted with openable extender crossbars, which increase the size of the interior of the e-chain®. Crossbars can be fitted in various ways: from one or both sides, alternating with standard crossbars and or any combination

TUB **New**

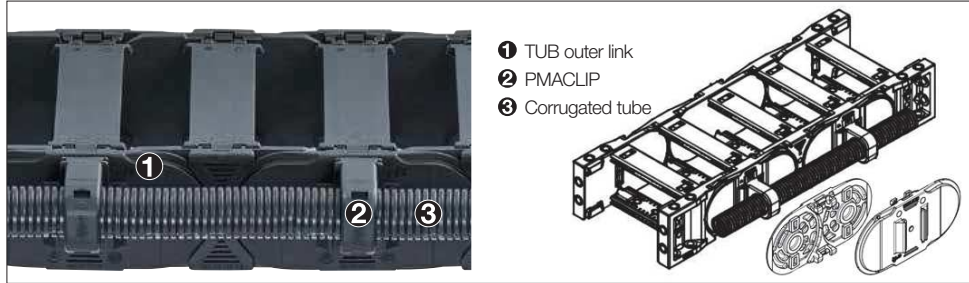

TUB | Safe guidance for corrugated tubes parallel to the e-chain®

- Additional, simple guidance for corrugated tubes on the outside of the e-chain®
- PMACLIP allows corrugated tubes with nominal widths 7, 10, 12, 17, 23, 29, 36mm to be easily clipped on
- Easy access to the corrugated tubes, fast replacement of the hoses
- Reduce assembly time and cost - easy to assemble, without any additional screws or tools
- The part number includes the e-chain® with TUB side sections; the PMACLIP support and the hose are ordered separately

Part No. TUB	Part No. TUB	Part No. TUB	For corrugated tube nominal diameter
Outer link right*	Outer link left*	Outer link at both ends*	Ø [mm]
E4.48L.XXXTUBR.R.0	E4.48L.XXXTUBL.R.0	E4.48L.XXXTUB.R.0	07 / 10 / 12 / 17 / 23 / 29 / 36

*View from the fixed end

Part number appended with width index **XXX Bi** and radius (**R**) e.g.

E4.48L.100TUBR.150.0 = with TUB outer sections every 2nd right hand link

Product range | PMACLIP | Support, one-piece, with safety clip

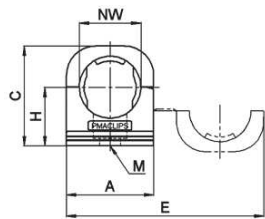

PMACLIP support - one-piece construction with safety clip, suitable for corrugated tubes

Part No.	NW	A	B	C	H	E	M
PMACLIP	Ø [mm]	mm	mm	mm	mm	mm	mm
I-BFH-07-0	07	17.0	20.0	21.5	13.5	40.5	M4
I-BFH-10-0	10	20.5	20.0	24.5	15.5	47.5	M5
I-BFH-12-0	12	24.0	20.0	27.0	16.5	54.5	M5
I-BFH-17-0	17	30.0	20.0	34.0	20.0	68.0	M6
I-BFH-23-0	23	38.5	20.0	42.0	24.0	85.0	M6
I-BFH-29-0	29	45.5	20.0	48.0	27.0	99.0	M6
I-BFH-36-0	36	55.5	20.0	56.0	31.0	119.0	M6

Steel support tray for support of the lower run

- Simple one-piece support trays for the lower run
 - To your requirements and specification
 - 4 options available
- More information ► From page 1264



Swarf up to +850°C

- e-tubes to withstand +850°C swarf, as a special option
 - No hot swarf melting or embedding into the chain
 - igus® igumid HT material
- More information ► www.igus.co.uk/HT



Assembled in seconds - honeycomb strain relief CFU

- Simply insert cables and hoses into the honeycomb and close
 - Strain relief of different cables in one slot
 - Easy to make changes to the filling
 - Can be used in gliding applications
- More information ► www.igus.co.uk/lean



Due to the modular design, the E4.1L system can be adapted to almost any application. As an open version for cable guidance, with extender crossbars for large hoses, or enclosed chip-resistant tube complete with guide trough - just three of many options