

Price index



Side-mounted -
unsupported



ESD classification:
Electrically conductive ESD/ATEX
version upon request



High torsional
rigidity



Opening E-Chains®: Remove crossbars and clips - Insert screwdriver into the slot, push down, release by lever action



Remove lids/bottoms (E-Tubes) - Insert screwdriver into the slot, release by lever action



When to use the Series 2828/2928/R7728:

- When high torsional or shearing forces are expected
- For side-mounted applications involving large unsupported lengths
- For long-term operation in very moist environments
- Also available as Rol E-Chain®



When not to use it:

- If a quieter version is required
▶ Series E4.32, page 7.34

- 1 High side-mount stability due to undercut
- 2 High torsional rigidity
- 3 Crossbars on E-Chains® are removable along both radii
- 4 Closed and open styles can be combined
- 5 Removable lids along inner radius
- 6 Hinged snap-open removable lids along outer radius of E-Tube
- 7 Lateral glide surfaces for side-mounted operation
- 8 Wide, rounded plastic crossbars - cable friendly
- 9 KMA mounting brackets with attachment points on all sides
- 10 Locking or pivoting mounting brackets available
- 11 E-Chain® also available with reverse bending radii



Rol E-Chain® Series
2828R/7728R available
upon request

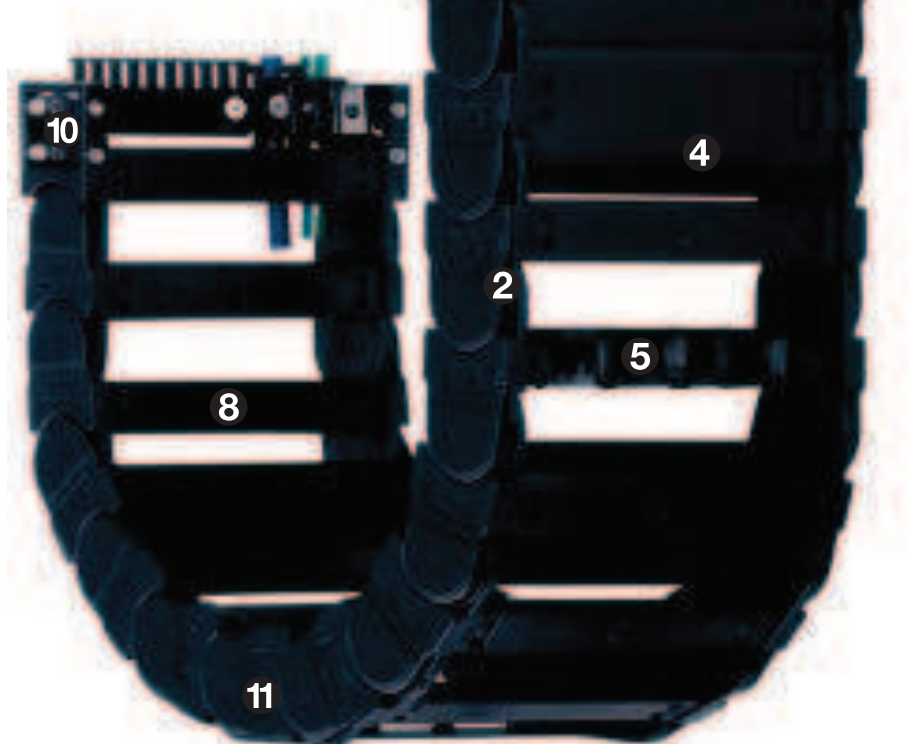

Order example complete E-Chain®

Please indicate chain-lengths or number of links Example: 3 m or 54 links

3 m 2828.30.300.0



E-Chain®

with 2 separators 282 assembled every 2nd link



Interior separation

1 set 28280.30.12C



Mounting bracket



Unsupported length

FL_G = with straight upper run

FL_B = with permitted sag

Further information ► **Design, page 1.12**

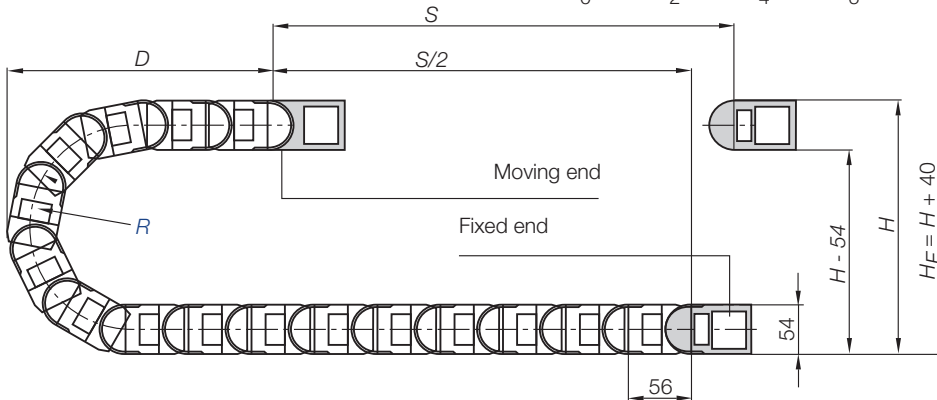
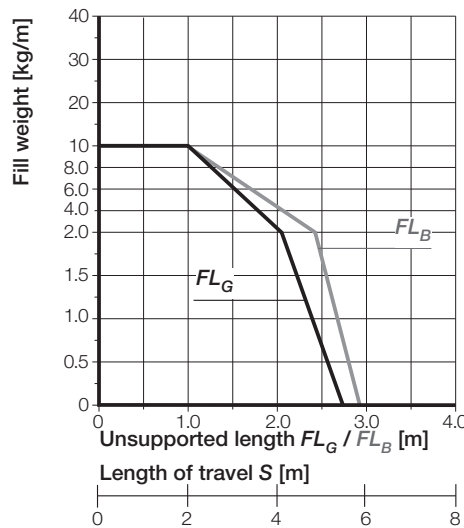
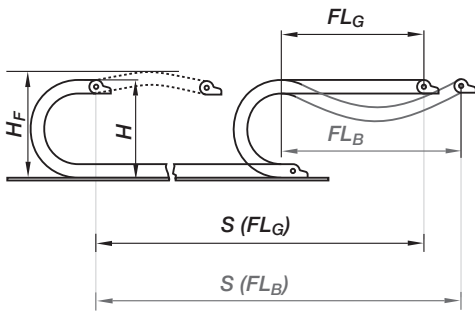

Pitch = 56 mm/link Links/m = 18 (1008 mm) Chain length = $S/2 + K$

R	063	075	100	125	150	175	200	220	250	300
H_{-20}^0	180	205	255	305	355	405	455	495	555	655
D	130	150	175	200	225	250	275	295	325	375
K	340	380	465	550	620	700	780	850	940	1110
H_2	180	205	166	166	166	166	166	166	166	166
D_2^{+20}	130	150	370	445	625	655	770	870	930	1240
K_2	340	380	616	784	1008	1064	1288	1456	1568	1960

- S = Length of travel
 - R = Bending radius
 - H = Nominal clearance height
 - H_F = Required clearance height
 - H_{RI} = Trough inner height
 - D = Overlength E-Chain® radius in final position
 - $K = \pi \cdot R + \text{"safety"}$
 - D_2 = Overlength - long travels, gliding
 - K_2 = *Further add-on
 - H_2 = *Mounting height
- *if the mounting bracket location is set lower

Other installation methods

- Vertical, hanging ≤ 70 m
- Vertical, standing ≤ 5 m
- Side mounted, un supp. ≤ 2 m
- Rotary requires further calculation
- Unsupported length of upper run = upon request

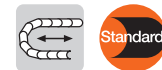

Short travels - unsupported

Unsupported E-Chains® feature positive camber over short travels. This must be accounted for when specifying the clearance height H_F . Please consult igus® if space is particularly restricted.

The required clearance height:
 $H_F = H + 40$ mm
(with 2,0 kg/m fill weight)

Long travel lengths from 10 m to max. 200 m Chain length = $S/2 + K_2$

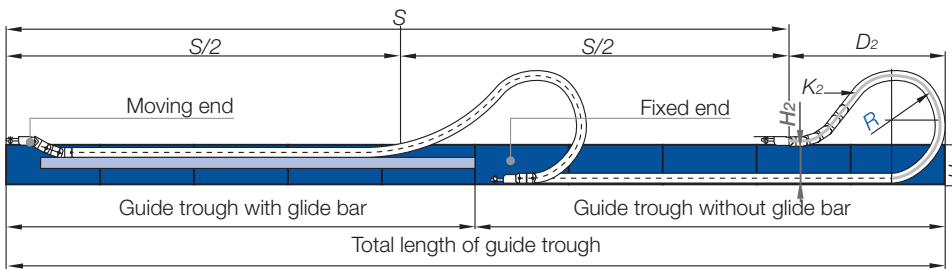

In case of travels between 4 and 10 m we recommend a longer unsupported length.



Gliding, long travel applications (max. 200 m)

In this case the E-Chain® upper run will be introduced in a guide trough on the lower run. We recommend to realize the engineering of such a plant by our technicians.

Speed / acceleration FL_G	max. 20 [m/s] / max. 200 [m/s ²]
Speed / acceleration FL_B	max. 3 [m/s] / max. 6 [m/s ²]
Gliding speed / acceleration (maximum)	max. 10 [m/s] / max. 50 [m/s ²]
Material - permitted temperature °C	igumid G / -40° up to +120° C
Flammability class, igumid G	VDE 0304 IIC UL94 HB

Technical Data



Details of material properties
► page 1.38

For support of the lower run - **Support Tray tool kit** available ► page 9.70



System E4/4
Inner height: 32 mm

Phone +49- (0) 22 03-96 49-800
Fax +49- (0) 22 03-96 49-222



► page 7.223

igus® E-ChainSystems®

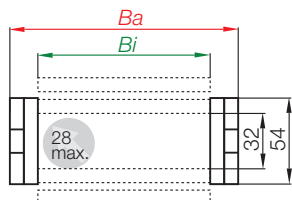

Part No. structure

2828. 30. 300. 0



Series 2828 - E-Chain® with crossbars every link

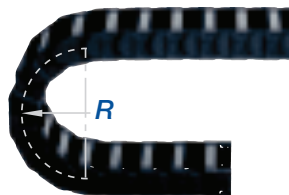

- Crossbars every link
- For rigid hydraulic hoses
- For applications particularly demanding
- Can be opened from two sides



Phone +49- (0) 22 03-96 49-800
Fax +49- (0) 22 03-96 49-222

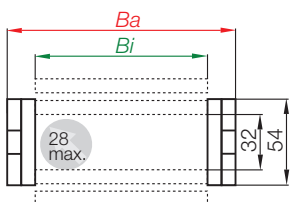

Part No. structure

2928. 30. 300. 0



Series 2928 - E-Chain® with crossbars every 2nd link

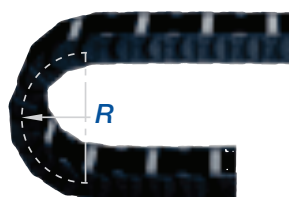

- Crossbars every 2nd link = Standard
- For nearly every situation
- Can be opened from two sides
- Easy assembly
- Stable
- Attractive price



igus® GmbH
51147 Cologne

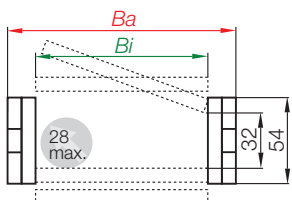

Part No. structure

7728. 30. 300. 0



Series R7728 - Fully enclosed E-Tube

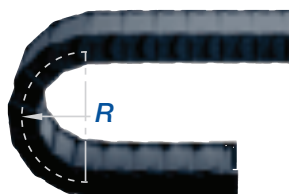

- Fully enclosed
- Excellent cable protection against dirt
- Protection against hot chips (up to 900°C)
- Lids along the entire inner radius are completely removable. Lids along the entire outer radius are single sided snap-open with a hinge on the other side to keep them attached to the chain or completely removable.



Internet: www.igus.eu
E-mail: info@igus.de

Rol instead of gliding: Rol E-Chain®

Special solution for long travels. 75% less drive power (gliding application) with igus® Rol E-Chain®.

Series 2828R - Order example 2828R.30.220.0

Further information: www.igus.de/en/role

or phone: +49-0 22 03-96 49-800



Part No.		<i>Bi</i> [mm]	<i>Ba</i> [mm]	2828 [kg/m]	2928 [kg/m]	R7728 [kg/m]
2828/2928/7728.05.	<input type="checkbox"/> .0*	50	74	≈ 1,73	≈ 1,64	≈ 2,63
2828/2928.06.	<input type="checkbox"/> .0	68	92	≈ 1,79	≈ 1,67	-
2828/2928/7728.07.	<input type="checkbox"/> .0	75	99	≈ 1,84	≈ 1,69	≈ 2,75
2828/2928.087.	<input type="checkbox"/> .0	87	111	≈ 1,93	≈ 1,73	-
2828/2928/7728.10.	<input type="checkbox"/> .0	100	124	≈ 2,02	≈ 1,78	≈ 2,83
2828/2928/7728.11.	<input type="checkbox"/> .0	108	132	≈ 2,08	≈ 1,81	≈ 2,94
2828/2928.112.	<input type="checkbox"/> .0	112	137	≈ 2,15	≈ 1,84	-
2828/2928/7728.12.	<input type="checkbox"/> .0	125	149	≈ 2,20	≈ 1,87	≈ 3,03
2828/2928.137.	<input type="checkbox"/> .0	137	162	≈ 2,29	≈ 1,91	-
2828/2928/7728.15.	<input type="checkbox"/> .0	150	174	≈ 2,38	≈ 1,96	≈ 3,19
2828/2928.162.	<input type="checkbox"/> .0	162	187	≈ 2,44	≈ 1,99	-
2828/2928/7728.17.	<input type="checkbox"/> .0	168	192	≈ 2,51	≈ 2,02	≈ 3,39
2828/2928.18.	<input type="checkbox"/> .0	175	199	≈ 2,56	≈ 2,05	-
2828/2928.187.	<input type="checkbox"/> .0	187	212	≈ 2,65	≈ 2,09	-
2828/2928/7728.20.	<input type="checkbox"/> .0	200	224	≈ 2,74	≈ 2,14	≈ 3,59
2828/2928.212.	<input type="checkbox"/> .0	212	237	≈ 2,87	≈ 2,20	-
2828/2928.23.	<input type="checkbox"/> .0	225	249	≈ 2,92	≈ 2,22	-
2828/2928.237.	<input type="checkbox"/> .0	237	262	≈ 3,05	≈ 2,29	-
2828/2928/7728.25.	<input type="checkbox"/> .0	250	274	≈ 3,10	≈ 2,32	≈ 4,04
2828/2928.262.	<input type="checkbox"/> .0	262	286	≈ 3,19	≈ 2,36	-
2828/2928.28.	<input type="checkbox"/> .0	275	299	≈ 3,28	≈ 2,41	-
2828/2928.29.	<input type="checkbox"/> .0	287	312	≈ 3,37	≈ 2,45	-
2828/2928/7728.30.	<input type="checkbox"/> .0	300	324	≈ 3,46	≈ 2,50	≈ 4,43
2828/2928.312.	<input type="checkbox"/> .0	312	337	≈ 3,59	≈ 2,56	-
2828/2928.325.	<input type="checkbox"/> .0	325	349	≈ 3,68	≈ 2,60	-
2828/2928.337.	<input type="checkbox"/> .0	337	362	≈ 3,77	≈ 2,65	-
2828/2928.350.	<input type="checkbox"/> .0	350	374	≈ 3,86	≈ 2,69	-
2828/2928.362.	<input type="checkbox"/> .0	362	387	≈ 3,95	≈ 2,74	-
2828/2928.375.	<input type="checkbox"/> .0	375	399	≈ 4,04	≈ 2,79	-
2828/2928.387.	<input type="checkbox"/> .0	387	412	≈ 4,11	≈ 2,82	-
2828/2928.400.	<input type="checkbox"/> .0	400	424	≈ 4,18	≈ 2,86	-

Available bending radii **not available for R7728 · *Removable lid only, no hinged option

R [mm] 063** 075** 100** 125 150 175 200 220 250 300

Supplement Part No. with required radius. Example: 2828.30.300.0

0 = standard color, other colors ▶ page 1.39 · Pitch = 56 mm/link - Links/m = 18

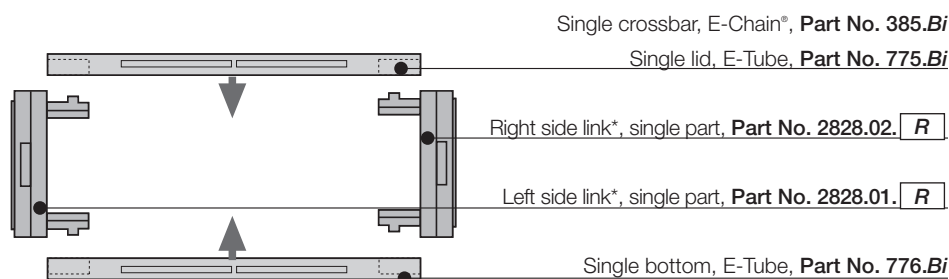

Hot Chips up to 850°C

E-Tubes that repel hot chips, up to 850°C. Some applications, depending on amount and size of the chips, can burn or melt the surface. That is no longer the case with the igus® "igumid HT" material. Order example:

Full E-Tube made of HT*:
7728.30.150.0.HT
 Lids made of HT:
7728.30.HTE.150.0

*for long travels upon request
 Further Information:
www.igus.de/en/HT
Delivery time
up to 4 weeks!



Extender crossbar for large diameter hoses ▶ page 7.230

Part No. E-Chain® - links, single parts

*View from the fixed point of the E-Chain®/E-Tube

System E4/4
 Inner height: 32 mm

Phone +49- (0) 22 03-96 49-800
 Fax +49- (0) 22 03-96 49-222



▶ page 7.223



Vertical separators are used if a vertical subdivision is required. In the standard configuration, a separator is mounted at every second link. **Note:** Observe a lateral spacing of at least 25 mm (E-Tube)

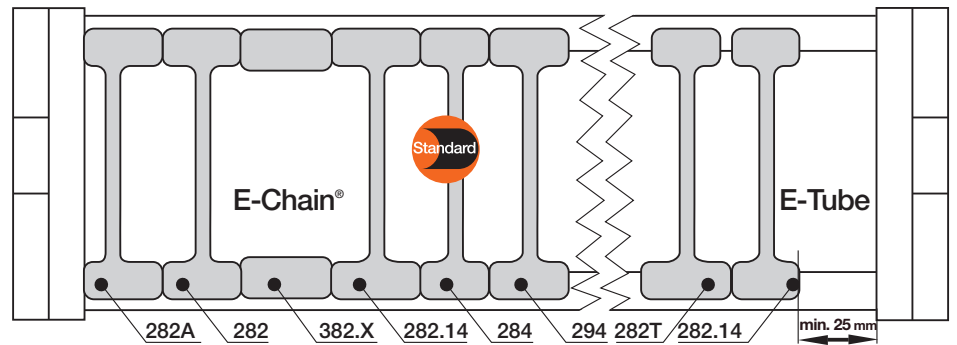

Vertical separator 281



Vertical separator 281T



Vertical separator 281.14



Vertical separator 283



Spacer 381.XX



Locking separator 293



Asymmetric separator 281A

Vertical separator for E-Chains®	
unassembled	281
assembled	282

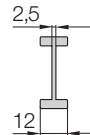

Vertical separator for E-Tubes	
unassembled	281T
assembled	282T

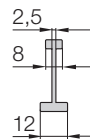

Vertical separator for E-Chains®/E-Tubes	
unassembled	281.14
assembled	282.14

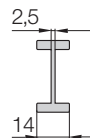

Vertical separator for E-Chains®	
unassembled	283
assembled	284

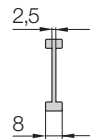

Spacer* for E-Chains®	
unassembled	381.XX
assembled	382.XX

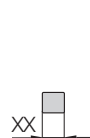

Locking separator for E-Chains®	
unassembled	293
assembled	294

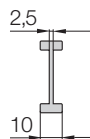

Asymmetric separator for E-Chains®	
unassembled	281A
assembled	282A

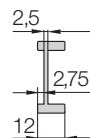

*For side-mounted applications

Option 1: Vertical separators and spacers

● **Standard separator 281 for E-Chains®** offers safe stability due to its broad foot design, also when used with thick cables or hoses. If the distance needed between separators is greater than this separator's dimension, we offer the **Vertical separator 281.14**.

● **Standard separator 281 for E-Chains®** offers safe stability due to its broad foot design, also when used with thick cables or hoses. If the distance needed between separators is greater than this separator's dimension, we offer the **Vertical separator 281.14**.

● **Vertical separator 283 with a narrow foot for E-Chains®** with applications where a large number of small cables need to be individually separated.

● Separators (e.g. "side mounted") for E-Chains® can be fixed in their position with **spacers 381.XX**. The available inner height will be reduced by 2 mm, per spacer and side. To avoid this, the parts can be assembled on outside of the crossbar (not for long travels) **XX = width of the spacer** (available 10, 15, 20).

Additionally

● **Locking separator 293 for E-Chains®** - with increased retention force for applications exposed to very high humidity or extreme loads. The extra retention force is achieved by asymmetric claws for the crossbar. Ensure proper alignment (not for E-Tubes).

● **Asymmetric separator 281A for E-Chains®** (not for E-Tubes) with an 12-mm base, for combinations between spacers of different widths and vertical separators in side-mounted applications, for instance.

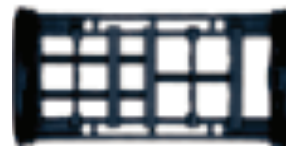
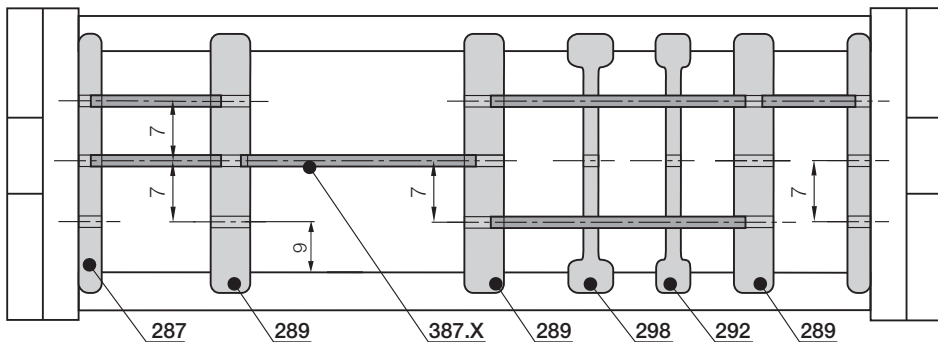

For use with many cables of differing diameters. E-Chains® and E-Tubes can be subdivided both vertically and horizontally. The shelves can be arranged elevator-shifted with different bottoms

Option 2: Shelves

● Side plates 286, middle plates 288 and shelves 386.X form the basic pattern of a shelf system. Shelves of various widths can be arranged at 3 different heights (in 7 mm increments).

● For special applications: Vertical separator with injection moulded shelf 281.S.57 (57,5 mm) or 281.S.45 (45 mm)

● Slotted separators 291 (not for E-Tubes), are used for very fine subdivisions. However, they cannot be retrofitted into an existing separation system without dismantling the interior separators first.

● The unilateral open slotted separator 297 can be retrofitted into an existing interior separation system without a need for dismantling the interior separators. During an installation of open slotted separators, the top and bottom notches cannot be occupied by shelves.

Side plate for E-Chains®/E-Tubes		
	unassembled	286
	assembled	287

Middle plate for E-Chains®/E-Tubes		
	unassembled	288
	assembled	289

Vertical separator for E-Chains®/E-Tubes		
	unassembled	281.S.57
	assembled	282.S.57

Vertical separator for E-Chains®/E-Tubes		
	unassembled	281.S.45
	assembled	282.S.45

Slotted separator for E-Chains®		
	unassembled	291
	assembled	292

Open slotted separator for E-Chains®/E-Tubes		
	unassembled	297
	assembled	298

Width X [mm]	Part No. unassembled	Part No. assembled
018	386.18	387.18
023	386.23	387.23
025	386.25	387.25
028	386.28	387.28
033	386.33	387.33
043	386.43	387.43
050	386.50	387.50
054	386.54	387.54
062	386.62	387.62
075	386.75	387.75

Width X [mm]	Part No. unassembled	Part No. assembled
087	386.87	387.87
100	386.100	387.100
108	386.108	387.108
125	386.125	387.125
150	386.150	387.150
175	386.175	387.175
200	386.200	387.200
208	386.208	387.208
225	386.225	387.225



Side plate 286

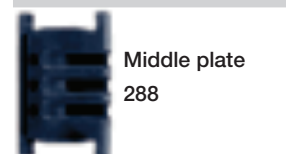

Middle plate 288

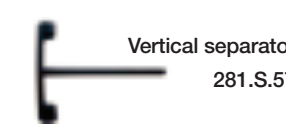

Vertical separator 281.S.57



Vertical separator 281.S.45



Slotted separator 291



Open slotted separator 297

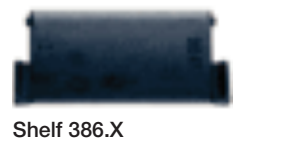

Shelf 386.X

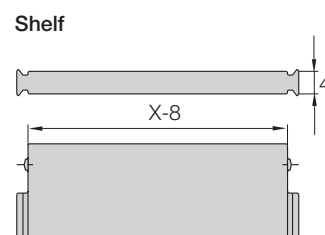

System E4/4
Inner height: 32 mm

Phone +49- (0) 22 03-96 49-800
Fax +49- (0) 22 03-96 49-222





Part No. structure
2828.10 /20 /10. .0
2828.Bi1/Bi2/Bi3. .0

Extension links - for extremely wide E-Chains® up to 3,0 m

- For applications in which particularly high fill weights necessitate extremely wide E-Chains® (up to 3000 mm)
- The extension link design allows virtually limitless side-by-side attachment of chains
- The unsupported length of a chain can be increased when additional loads are required
- Extension links can be used with E-Chains®, E-Tubes or as a combination of both
- They are suitable for unsupported and gliding applications in a guide trough
- E-Chains® with extension links are attached with KMA or steel mounting brackets

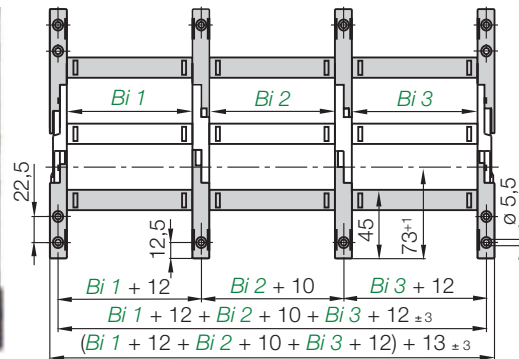
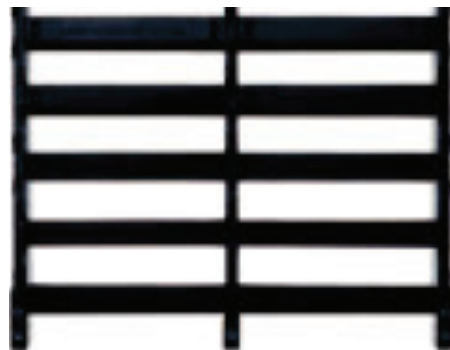

Consult igus® for your extender crossbar applications. We are happy to assist you with your design layout

Extender crossbars - careful guide of hoses applications

- Suitable for hoses with a maximum outer diameter of 105 mm
- Gliding operation with crossbars assembled along the outer radius and a special guide trough
- Gliding operation not guaranteed with crossbars assembled along the inner radius
- The extender crossbar can either be attached to the side links directly or can be used in combination with two stranded snap-open crossbars

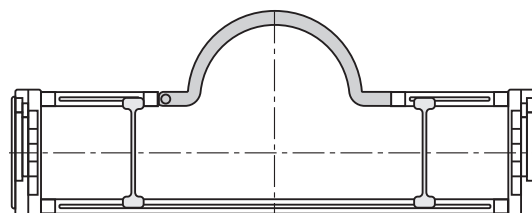

385.15RHD115 round extender crossbar combined with snap-open crossbars

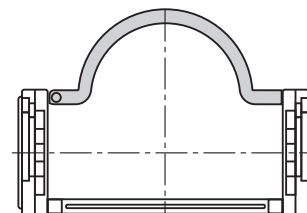

385.18RD115 round strap assembled directly on the side section

Part No.	Max Ø [mm] hose	Form	Installation side link	Combination with snap-open crossb.
385.15.RHD115	105	○	-	+
385.18.RD115	105	○	+	-

○ = round + = yes / - = no



Hinged crossbars

- Typically E-Chain® crossbars are completely removable. In cases where the snap-open crossbars have to remain at the open link of the E-Chain®, a hinged design has been developed
- Length: 37,5 mm **Part No. 385.02** / snap-open crossbar (shortened): Bi-37,5 mm **Part No. 385.03**
- Please consult igus® for design assistance

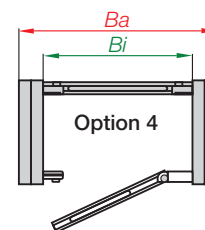
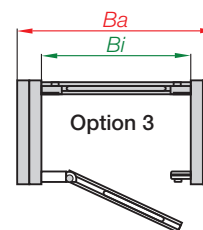
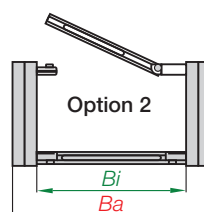
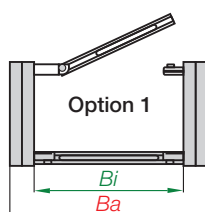
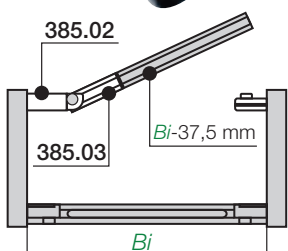

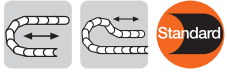

The Standard - Option KMA* - pivoting

- Recommended for unsupported and gliding applications
- Confined installation conditions
- Option - integrated C-profile strain relief device with Chainfix clip or strain relief tiwrap plates
- Corrosion resistant
- Universal mountable with attachment capability on all sides

*KMA = Polymer Metal Mounting Bracket

Moving end
28280/77280...1

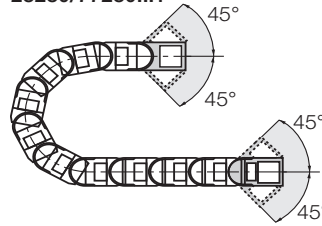

Fixed end
28280/77280...2



The attachment variants arising automatically by the choice of the KMA mounting bracket

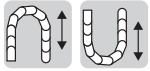
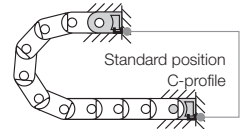

Option KMA - locking

- Recommended for vertical hanging / standing applications

Additionally:

- Universal mountable
- C-profile option
- Corrosion resistant
- Locked connections
- At very high acceleration

Moving end
29280/78280...1

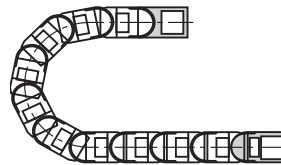

Fixed end
29280/78280...2



The attachment variants arising automatically by the choice of the KMA mounting bracket

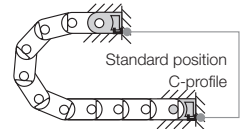

Fixed end

28280/77280...2 (pivoting)
29280/78280...2 (locking)

Moving end

(pivoting) 28280/77280...1
(locking) 29280/78280...1

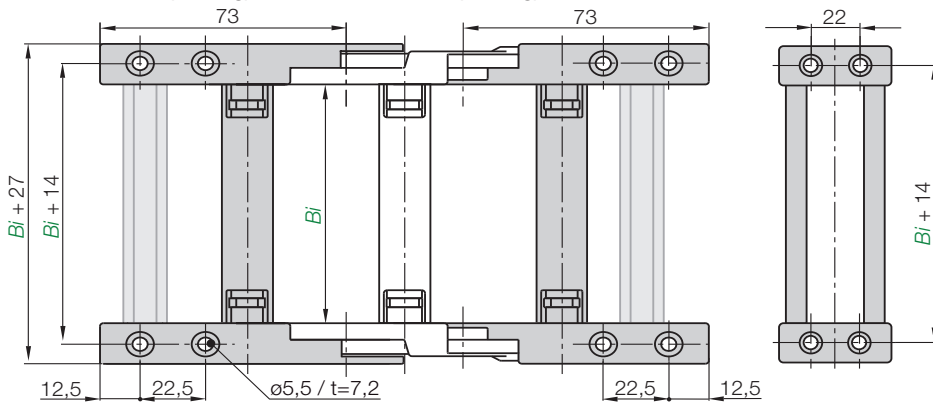

Dimensions and order configurations

Part No. structure (pivoting)

28280.	05.	12.	C
--------	-----	-----	---

Optional with C-profile
Full set
Width
28280 = E-Chain®
77280 = E-Tube

Part No. structure (locking)

29280.	05.	12.	C
--------	-----	-----	---

Optional with C-profile
Full set
Width
29280 = E-Chain®
78280 = E-Tube

Width index	Part No. full set pivoting	Part No. full set locking	C-profile option [mm]	Width index	Part No. full set pivoting	Part No. full set locking	C-profile option [mm]
.05.	28280/77280	29280/78280	.05.12.C 50	.23.	28280	29280	.23.12.C 225
.06.	28280	29280	.06.12.C 68	.237.	28280	29280	.237.12.C 237
.07.	28280/77280	29280/78280	.07.12.C 75	.25.	28280/77280	29280/78280	25.12.C 250
.087.	28280	29280	.087.12.C 87	.262.	28280	29280	.262.12.C 262
.10.	28280/77280	29280/78280	.10.12.C 100	.28.	28280	29280	.28.12.C 275
.11.	28280/77280	29280/78280	.11.12.C 108	.29.	28280	29280	.29.12.C 287
.112.	28280	29280	.112.12.C 112	.30.	28280/77280	29280/78280	.30.12.C 300
.12.	28280/77280	29280/78280	.12.12.C 125	.312.	28280	29280	.312.12.C 312
.137.	28280	29280	.137.12.C 137	.325.	28280	29280	.325.12.C 325
.15.	28280/77280	29280/78280	.15.12.C 150	.337.	28280	29280	.337.12.C 337
.162.	28280	29280	.162.12.C 162	.350.	28280	29280	.350.12.C 350
.17.	28280/77280	29280/78280	.17.12.C 168	.362.	28280	29280	.362.12.C 362
.18.	28280	29280	.18.12.C 175	.375.	28280	29280	.375.12.C 375
.187.	28280	29280	.187.12.C 187	.387.	28280	29280	.387.12.C 387
.20.	28280/77280	29280/78280	.20.12.C 200	.400.	28280	29280	.400.12.C 400
.212.	28280	29280	.212.12.C 212				

Full set, for both ends:

28280.05.12

Single-part order:

28280.05.1

Mounting bracket moving end

28280.05.2

Mounting bracket fixed end



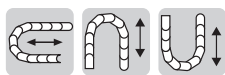

Option steel - pivoting

- For pivoting connections
- One part (two-piece) for all chain widths
- Electrically conductive

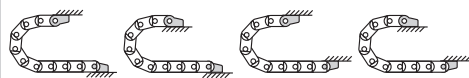

Possible installation conditions -

Further installation angles ► installation sketch

Moving end
28280.1

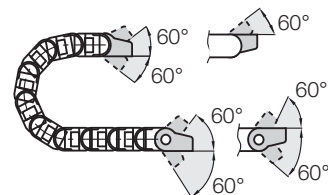

Fixed end
28280.2

Phone +49- (0) 22 03-96 49-800
Fax +49- (0) 22 03-96 49-222

igus® GmbH
51147 Cologne

Internet: www.igus.eu
E-mail: info@igus.de

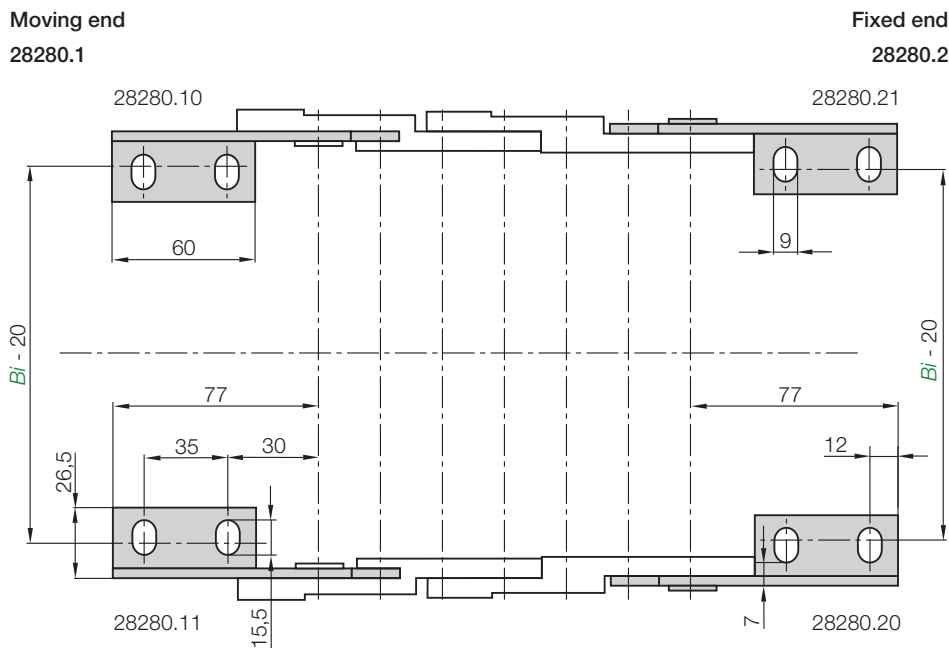

For	Part No.	Bi	For	Part No.	Bi
E-Chain®	full set	[mm]	E-Chain®	full set	[mm]
2828-2928-7728.05 ►	28280.12	50	2828-2928.23 ►	28280.12	225
2828-2928.06 ►	28280.12	68	2828-2928.237 ►	28280.12	237
2828-2928-7728.07 ►	28280.12	75	2828-2928-7728.25 ►	28280.12	250
2828-2928.087 ►	28280.12	87	2828-2928.262 ►	28280.12	262
2828-2928-7728.10 ►	28280.12	100	2828-2928.28 ►	28280.12	275
2828-2928-7728.11 ►	28280.12	108	2828-2928.29 ►	28280.12	287
2828-2928.112 ►	28280.12	112	2828-2928-7728.30 ►	28280.12	300
2828-2928-7728.12 ►	28280.12	125	2828-2928.312 ►	28280.12	312
2828-2928.137 ►	28280.12	137	2828-2928.325 ►	28280.12	325
2828-2928-7728.15 ►	28280.12	150	2828-2928.337 ►	28280.12	337
2828-2928.162 ►	28280.12	162	2828-2928.350 ►	28280.12	350
2828-2928-7728.17 ►	28280.12	168	2828-2928.362 ►	28280.12	362
2828-2928.18 ►	28280.12	175	2828-2928.375 ►	28280.12	375
2828-2928.187 ►	28280.12	187	2828-2928.387 ►	28280.12	387
2828-2928-7728.20 ►	28280.12	200	2828-2928.400 ►	28280.12	400
2828-2928.212 ►	28280.12	212			

28280.12 Full set, 4 parts
2 with pin / 2 with bore

Single-part order:

28280.1 Mounting bracket
moving end, 1 part left / right
28280.2 Mounting bracket
fixed end, 1 part left / right

Other strain relief elements
► chapter 10

Chainfix clamps for the C-profile

Part No. single clamps		Part No. double clamps		Part No. triple clamps		Cable ø [mm]
steel	stainless steel	steel	stainless steel	steel	stainless steel	
CFX12.1	CFX12.1.E	CFX12.2	CFX12.2.E	CFX12.3	-	06 - 12
CFX14.1	CFX14.1.E	CFX14.2	CFX14.2.E	CFX14.3	-	12 - 14
CFX16.1	CFX16.1.E	CFX16.2	CFX16.2.E	CFX16.3	-	14 - 16
CFX18.1	CFX18.1.E	CFX18.2	CFX18.2.E	CFX18.3	-	16 - 18
CFX20.1	CFX20.1.E	CFX20.2	CFX20.2.E	CFX20.3	-	18 - 20
CFX22.1	CFX22.1.E	CFX22.2	CFX22.2.E	CFX22.3	-	20 - 22
CFX26.1	CFX26.1.E	CFX26.2	CFX26.2.E	-	-	22 - 26
CFX30.1	CFX30.1.E	CFX30.2	CFX30.2.E	-	-	26 - 30
CFX34.1	CFX34.1.E	CFX34.2	CFX34.2.E	-	-	30 - 34
CFX38.1	CFX38.1.E	-	-	-	-	34 - 38
CFX42.1	CFX42.1.E	-	-	-	-	38 - 42

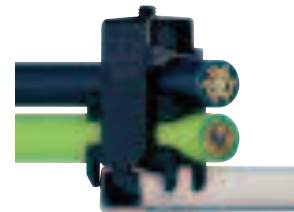

igus® Chainfix steel clamps and Chainfix stainless-steel clamps - max. pull forces, adjustable with hexagon socket. Available as single, double or triple clamps. **Details ▶ chapter 10**

System E4/4
Inner height: 32 mm

Cable ø [mm]	Part No. clamp	Part No. bottom part
04 - 08	CFC-08-M	CFC-08-C
08 - 12	CFC-12-M	CFC-12-C
12 - 16	CFC-16-M	CFC-16-C
16 - 20	CFC-20-M	CFC-20-C
20 - 24	CFC-24-M	CFC-24-C

Chainfix Clip - Modular snap-on strain relief device for C-profile

Available for all igus® E-ChainSystems® with C-profiles and also suitable for assembly in the KMA mounting brackets and clip-on strain relief for crossbars. High pull forces, plug-in modular snap-on strain relief device. **Details ▶ chapter 10**

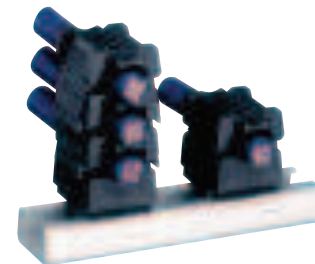

Part No.	ø max. conduit [mm]	Width [mm]
CFN.20	20	10,8
CFN.30.52	30	16,8
CFN.20.N35	20	20,0

Chainfix Nugget for the C-Profile

Strain relief for the fixation of cables up to a diameter of Ø 30 mm. Easy to assemble, without any screws and tools. Easy strain relief due to fixation with pre-harnessed cable strap, very small space requirement. **Details ▶ chapter 10**



Part No.	Width of strain relief [mm]	Number of teeth
3050.ZC	50	5
3075.ZC	75	7

Chainfix tiwrap plates with clip-on connection for the C-profile

Can be plugged into the KMA C-profile. Easy to assemble without any screws. Easily solvable with screwdriver nevertheless safe stop. For all E-Chains® with KMA and integrated C-profile. **Details ▶ chapter 10**

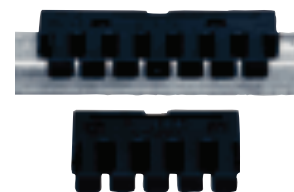

Tiewrap plate	No. of teeth n	Dim. C [mm]	Dim. B [mm]	Center bore
3050.ZB	5	50	30	-
3075.ZB	7	75	55	-
3100.ZB	10	100	80	-
3115.ZB	11	115	95	-
3125.ZB	12	125	105	-
3150.ZB	15	150	130	-
3175.ZB	17	175	155	-
3200.ZB	20	200	180	+
3225.ZB	22	225	205	+
3250.ZB	25	250	230	+

(- = no / + = yes)

Tiewrap plate as individual part

As individual component screwed on KMA. Can be plugged in the mounting brackets. **Details ▶ chapter 10**

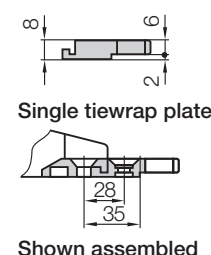
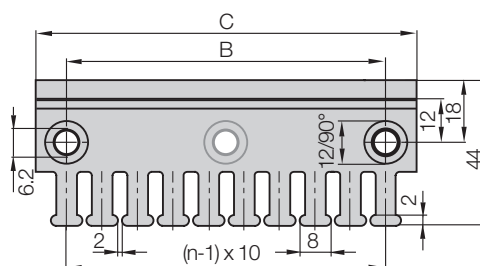

Details about all strain relief option for this series ▶ chapter 10

Phone +49- (0) 22 03-96 49-800
Fax +49- (0) 22 03-96 49-222



▶ page 7.223

- B_a = Outer width E-Chains® / E-Tube
- B_i = Inner width E-Chains® / E-Tube
- h_a = Outer height E-Chains® / E-Tube
- H_{Ri} = Inner trough height
- H_{Ra} = Outer trough height
- B_{Ri} = Inner trough width ▶ depends on dim. B_a
- B_{Ra} = Outer trough width
- n_{Mon} = Number of installation sets (left/right)
- n_{Ri} = Number of troughs sets (left/right)
- ! $H_{Ri} \geq 2 \cdot h_a$
- $B_{Ri} \geq B_a + 4$
- = Guide trough set ● = Glide bar
- = Installation set "Basic" ● = C-profile

Installation set "Basic" with C-profile

Bottom Clamp attached optionally inwards or outwards

2828.05.200.0 ▶ Order example

	B_{Ri} [mm]	Part No. attached inwards	Part No. attached outwards
.06	96	960.30.150	960.30.200
.07	103	960.30.150	960.30.200
.087	115	960.30.175	960.30.225
.10	128	960.30.175	960.30.225
.11	136	960.30.200	960.30.225
.112	141	960.30.200	960.30.250
.12	153	960.30.200	960.30.250
.137	166	960.30.225	960.30.275
.15	178	960.30.225	960.30.275
.162	191	960.30.250	960.30.300
.17	196	960.30.250	960.30.300
.18	203	960.30.250	960.30.300
.187	216	960.30.275	960.30.325
.20	228	960.30.275	960.30.325
.212	241	960.30.300	960.30.350
.23	253	960.30.300	960.30.350
.237	266	960.30.325	960.30.375
.25	278	960.30.325	960.30.375
.262	291	960.30.350	960.30.400
.28	303	960.30.350	960.30.400
.29	316	960.30.375	960.30.425
.30	328	960.30.375	960.30.425
.312	341	960.30.400	960.30.450
.325	353	960.30.400	960.30.450
.337	366	960.30.425	960.30.475
.350	378	960.30.425	960.30.475
.362	391	960.30.450	960.30.500
.375	403	960.30.450	960.30.500
.387	416	960.30.475	960.30.525
.400	428	960.30.475	960.30.525

Insert for the installation set "Heavy-Duty": **972.50.XXX** instead of **960.30.XXX** on the right column "attached outwards"

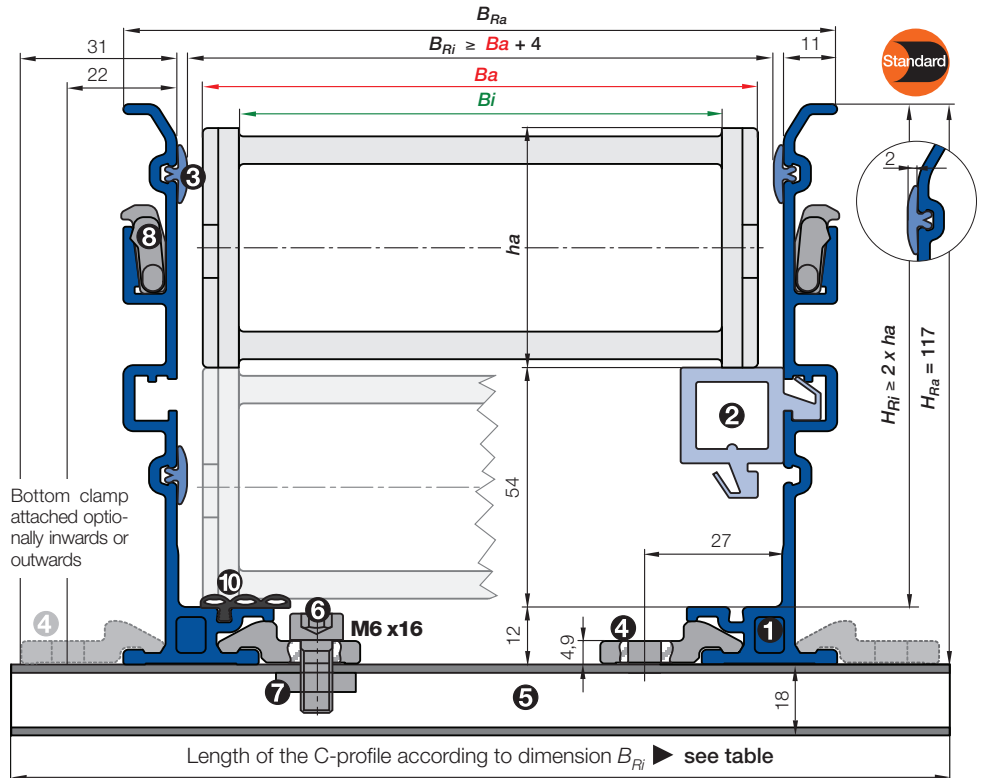

- **Components, trough "Basic":** ① Trough side parts, aluminum, 2 m ② Glide bar, plastic, 2 m ③ Glide strips, plastic, 2 m (without glide strips on request) ⑩ Optional: Silencer profile, rubber
- **Components, installation set "Basic":** ④ Bottom clamp, aluminum ⑤ C-profile, steel galvanized ⑥ Screw M6 x16 ⑦ Sliding nut M6 ⑧ Interface connector, plastic



Order example: Length of travel 30 m - Center mounted for Series 2828.30.300.0 with $B_{Ri} = 328$

Guide trough set (set of 2 trough side parts, incl. glide strips) without glide bar	Order text: 16 m guide trough without glide bar (8 x 2 m sections)	Part No. 972.30.SL
Guide trough set (set of 2 trough side parts, incl. glide strips) with glide bar	Order text: 16 m guide trough with glide bar (8 x 2 m sections)	Part No. 972.31.SL
Installation set "Basic" complete (guide trough-sets + 1)	Order text: 17 installation sets "Basic"	Part No. 960.30.375
Module for the fixed end	Order text: 1 set	Part No. 972.80
Option: For an additional noise dampening with silencer profile, please add Index A - Example:		Part No. 972.30.SLA

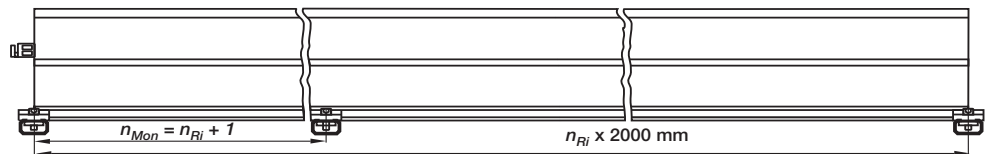

Principle sketch: Number of installation sets to be installed = Number of trough sections + 1

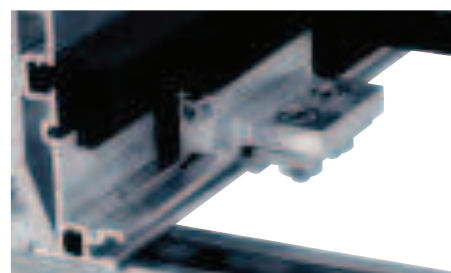

A quick fix for mounting the stationary end of an E-Chain®

With this module for the fixed end, fast and easy mounting onto the Aluminum "SuperTrough" is now possible without any drilling. Fast mounting of the E-Chain® by clamping onto the aluminum trough

- Quick relocation of the stationary end
- No drilling necessary ▶ page 9.16

Phone +49- (0) 22 03-96 49-800
Fax +49- (0) 22 03-96 49-222

igus® GmbH
51147 Cologne

Internet: www.igus.eu
E-mail: info@igus.de



High unsupported lengths and perfect suitability für circular movements (RBR-versions) are some features for the E4/4-System

System E4/4
Inner height: 32 mm

Phone +49- (0) 22 03-96 49-800
Fax +49- (0) 22 03-96 49-222



▶ Chapter 9



▶ page 7.223