

igus® E-ChainSystems®

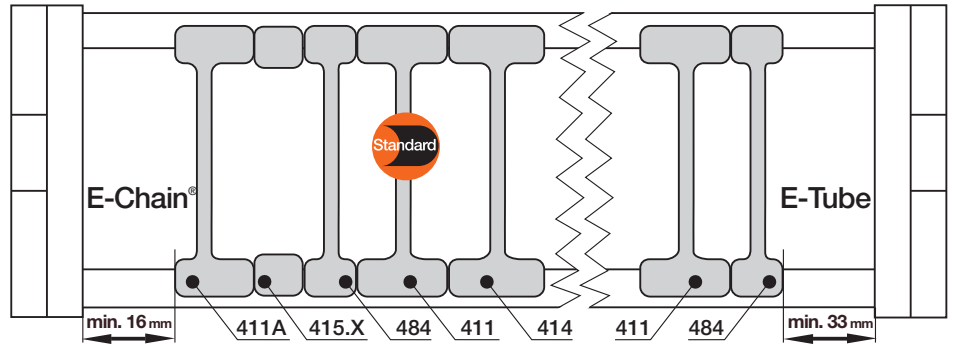

Vertical separators are used if a vertical subdivision is required. In the standard configuration, a separator is mounted at every second link. **Note:** Observe a lateral spacing of at least 33 mm (E-Tube) and 16 mm (E-Chain)!



Phone +49- (0) 22 03-96 49-800
Fax +49- (0) 22 03-96 49-222

igus® GmbH
51147 Cologne

Internet: www.igus.eu
E-mail: info@igus.de



Vertical separator 401



Vertical separator 483



Spacer 405.XX



Locking separator 404



Vertical separator 406



Asymmetric separator 401A

Vertical separator for E-Chains®/E-Tubes	
unassembled	401
assembled	411

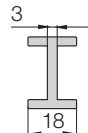

Vertical separator for E-Chains®/E-Tubes	
unassembled	483
assembled	484

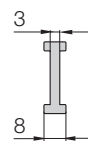

Spacer* for E-Chains®	
unassembled	405.XX
assembled	415.XX



Locking separator for E-Chains®	
unassembled	404
assembled	414

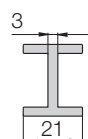

Vertical separator for E-Tubes	
unassembled	406
assembled	416

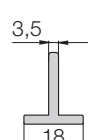

Asymmetric separator for E-Chains®	
unassembled	401A
assembled	411A

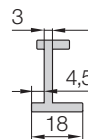

*For side-mounted applications

Option 1: Vertical separators and spacers

● **Standard separator 401 for E-Chains®/E-Tubes** offers safe stability due to its broad foot design, also when used with thick cables or hoses.

● **Vertical separator 483 with a narrow foot for E-Chains® and E-Tubes** with applications where a large number of small cables need to be individually separated.

● Separators (e.g. "side mounted") for E-Chains® can be fixed in their position with **Spacers 405.XX**. The available inner height will be reduced by 2 mm, per spacer and side. To avoid this, the parts can be assembled on outside of the crossbar (not for long travels) **XX = width of the spacer** (available 10, 15, 20, 30 and 40 mm)

Additionally:

● **Locking separator for E-Chains® 404** - with increased retention force for applications exposed to very high humidity or extreme loads. The extra retention force is achieved by asymmetric claws for the crossbar. Ensure proper alignment

● **Locking separator 406 for E4-Tubes** - safe fitting locked on lid or bottom of the Tube and sideways slideable. The opposing lid or bottom can easily be opened and closed. Especially capable if many separators need to be assembled on a tight inner width

● **Asymmetric separator 401A for E-Chains®** with an 18-mm base, for combinations between spacers of different widths and vertical separators in side-mounted applications, for instance.

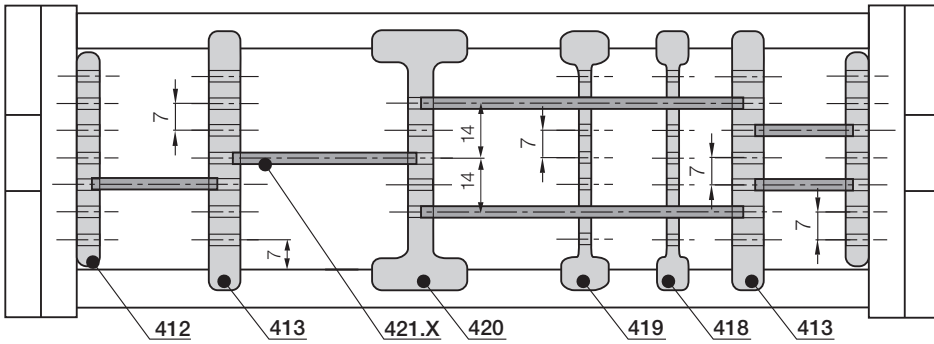

For use with many cables of differing diameters. E-Chains® and E-Tubes can be subdivided both vertically and horizontally. The shelves can be arranged elevator-shifted with different bottoms

Option 2: Shelves

● Side plates 402, middle plates 403 and shelves 420.X form the basic pattern of a shelf system. Shelves of various widths can be arranged at 7 different heights (in 7 mm increments).

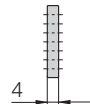

Side plate for E-Chains®/E-Tubes	
unassembled	402
assembled	412

● Locking vertical separator 410, slotted combined with shelves (only for E-Chains®).

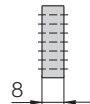

Middle plate for E-Chains®/E-Tubes	
unassembled	403
assembled	413

● Slotted separators 408 are used for very fine subdivisions. However, they cannot be retrofitted into an existing separation system without dismantling the interior separators first.

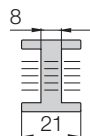

Locking vertical separator for E-Chains®	
unassembled	410
assembled	420

● The unilateral open slotted separator 409 can be retrofitted into an existing interior separation system without a need for dismantling the interior separators. During an installation of open slotted separators, the top and bottom notches cannot be occupied by shelves.

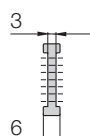

Slotted separator for E-Chains®/E-Tubes	
unassembled	408
assembled	418

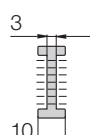

Open slotted separator for E-Chains®/E-Tubes	
unassembled	409
assembled	419

Width X [mm]	Part No. unassembled	Part No. assembled
018	420.18	421.18
023	420.23	421.23
025	420.25	421.25
028	420.28	421.28
033	420.33	421.33
043	420.43	421.43
050	420.50	421.50
062	420.62	421.62

Width X [mm]	Part No. unassembled	Part No. assembled
075	420.75	421.75
088	420.88	421.88
100	420.100	421.100
125	420.125	421.125
150	420.150	421.150
175	420.175	421.175
187	420.187	421.187
200	420.200	421.200

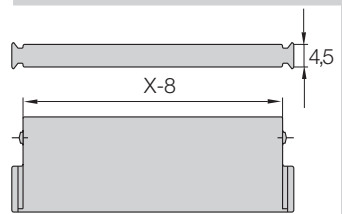
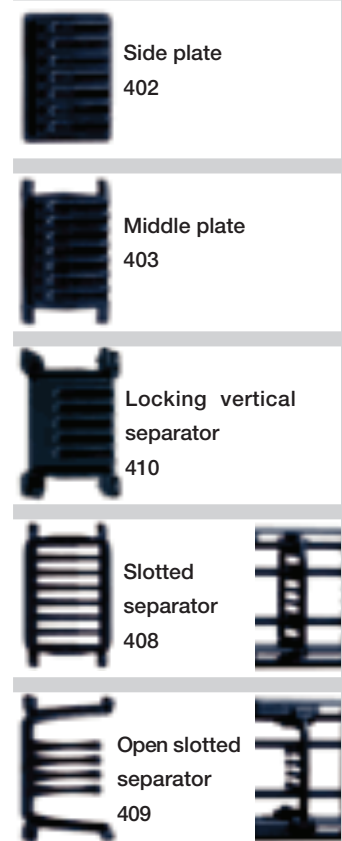

Additional elements for interior separation

Center crossbar	
unassembled	405
assembled	415

Center crossbar - was developed for applications with a large number of thin cables. The center crossbar offers the option of subdividing the E-Chain® independently into upper and lower halves.

Rollclip	
unassembled	489.27
assembled	490.27

Rollclip - minimizes abrasion of particularly sensitive hoses. The Rollclip is simply clamped onto the opening crossbar. The movable rollers compensate for relative movement between the chain and hose.

Roller separator	
unassembled	429
assembled	430

Roller separator - performs a similar function to the Rollclip, but doubles as a separator.

System E4/4
Inner height: 56 mm
Phone +49- (0) 22 03-96 49-800
Fax +49- (0) 22 03-96 49-222

