



iglidur® F – The Lightning Conductor



Electrically conductive

High compressive strength

High temperature resistance

High p x v value

Good resistance to chemicals

iglidur® F

Phone +49 - 22 03 - 96 49-145
Fax +49 - 22 03 - 96 49-334

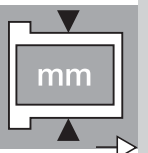
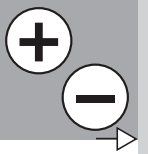

mm



igus®

iglidur® F | The Lightning Conductor

When the electrical conductivity of plain bearings is important, i.e. applications in which electrostatic charging must not occur iglidur® F is the right choice. In addition, plain bearings made from iglidur® F are very resistant to pressure.

iglidur® F

2 styles
> 50 dimensions
Ø 2-70 mm



Phone +49 - 22 03 - 96 49-145
Fax +49 - 22 03 - 96 49-334

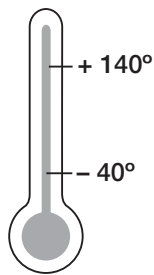

igus® GmbH
51147 Cologne

Price index



The Lightning Conductor



When to use iglidur® F plain bearings:

- When electrical conductivity is especially important
- For high static loads
- For low to average speeds
- High p x v value
- Good chemical and temperature resistance

When not to use iglidur® F plain bearings:

- When mechanical reaming of the wall surface is necessary
▶ iglidur® M250 (chapter 4)
- When the highest wear resistance is needed
▶ iglidur® W300 (chapter 5)
- When very low coefficients of friction in the dry run are needed
▶ iglidur® X (chapter 6),
iglidur® J (chapter 3)
- For underwater applications
▶ iglidur® H370 (chapter 15),
iglidur® UW500 (chapter 30)

Internet www.igus.de
E-mail info@igus.de



Material Table

General Properties	Unit	iglidur® F	Testing Method
Density	g/cm ³	1,25	
Colour		Black	
Max. moisture absorption at 23°C/50% r.F.	% weight	1,8	DIN 53495
Max. moisture absorption	% weight	8,4	
Coefficient of sliding friction, dynamic against steel μ		0,10 - 0,39	
$p \times v$ value, max. (dry)	MPa x m/s	0,34	
Mechanical Properties			
Modulus of elasticity	MPa	11.600	DIN 53457
Tensile strength at 20°C	MPa	260	DIN 53452
Compression resistance	MPa	98	
Max. recommended surface pressure (20°C)	MPa	105	
Shore D hardness		84	DIN 53505
Physical and Thermal Properties			
Max. long term application temperature	°C	140	
Max. short term application temperature	°C	180	
Min. application temperature	°C	-40	
Thermal conductivity	W/m x K	0,65	ASTM C 177
Coefficient of thermal expansion (at 23°C)	K ⁻¹ x 10 ⁻⁵	12	DIN 53752
Electrical Properties			
Specific volume resistance	Ω cm	< 10 ³	DIN IEC 93
Surface resistance	Ω	< 10 ²	DIN 53482

¹⁾ The good conductivity of this plastic material under certain circumstances can favour the generation of corrosion on the metallic contact component.

Table 11.1: Material Data

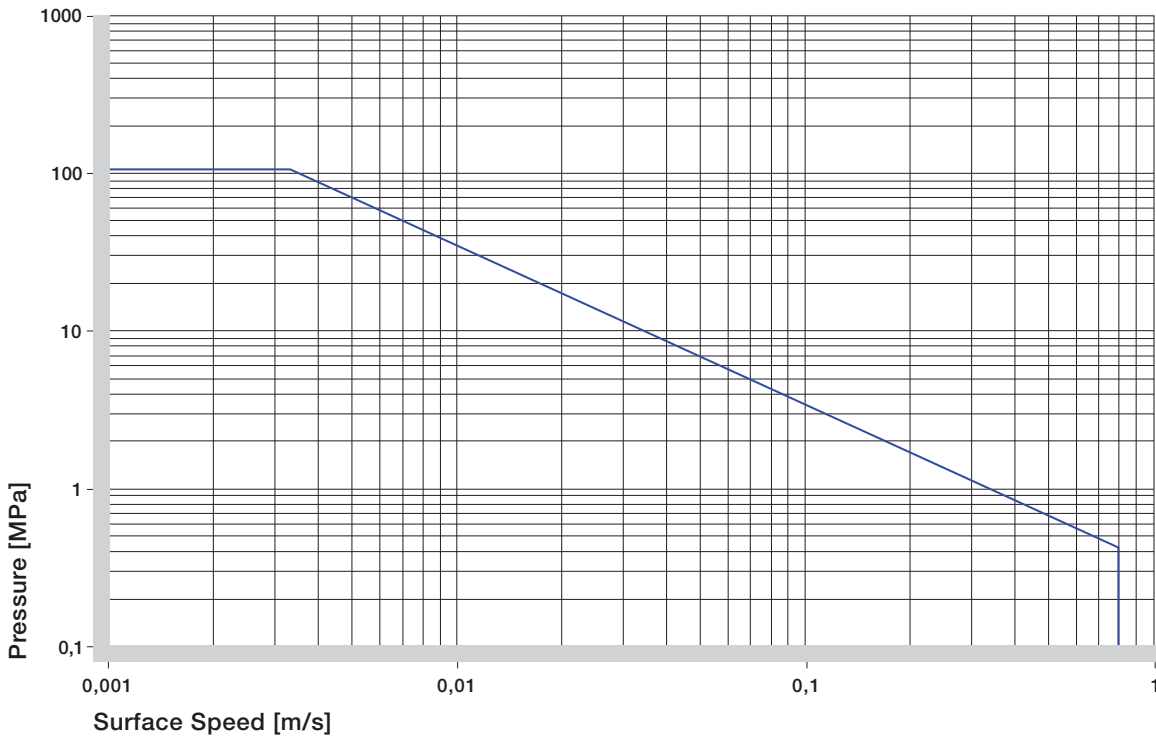

Graph 11.1: Permissible $p \times v$ values for iglidur® F running dry against a steel shaft, at 20°C





iglidur® F

Phone +49 - 22 03 - 96 49-145
Fax +49 - 22 03 - 96 49-334

igus® GmbH
51147 Cologne

Internet www.igus.de
E-mail info@igus.de

11.4

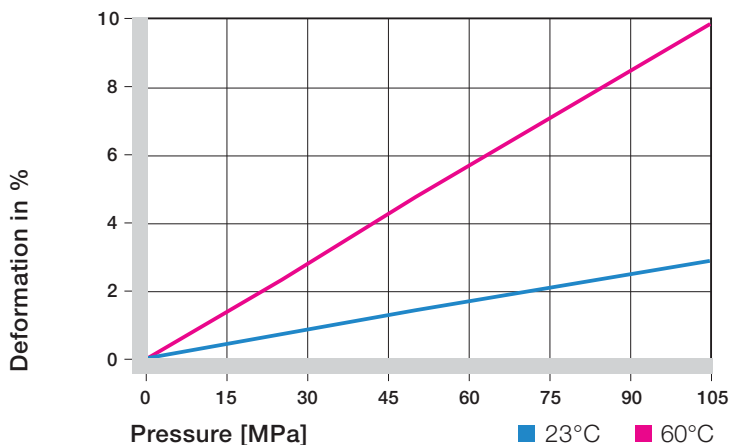

Graph 11.2: Deformation under pressure and temperature

m/s	Rotating	Oscillating	Linear
Continuous	0,8	0,6	3
Short term	1,5	1,1	5

Table 11.2: Maximum surface speeds

iglidur® F	Application Temperature
Minimum	-40 °C
Max., long term	+140 °C
Max., short term	+180 °C

Table 11.3: Temperature limits for iglidur® F

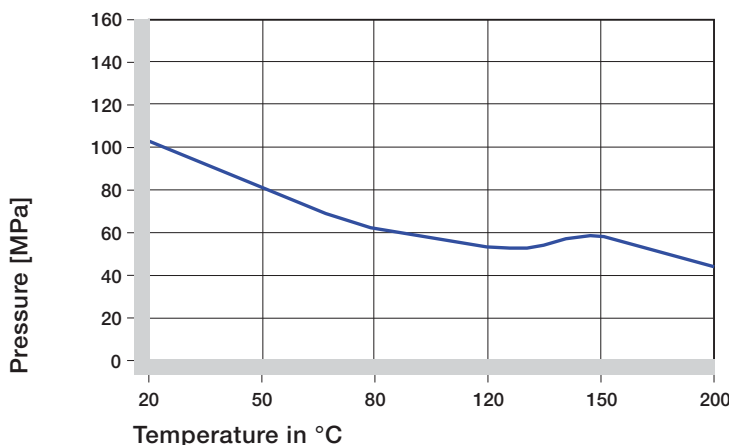

Graph 11.3: Recommended maximum surface pressure of iglidur® F as a function of temperature

iglidur® F	Dry	Grease	Oil	Water
C.o.f. [μ]	0,1-0,39	0,09	0,04	0,04

Table 11.4: Coefficient of friction for iglidur® F against steel (Ra = 1μm, 50 HRC)

When electrical conductivity of plain bearings is important, i.e. applications in which electrostatic charging must not occur, iglidur® F is the right choice. In addition, plain bearings made of iglidur® F are very resistant to pressure.

Surface Pressure

At room temperature, iglidur® F bearings can achieve loads up to 100 MPa.

Graph 11.2 shows the elastic deformation of iglidur® F for radial loads. At the recommended maximum surface pressure of approximately 105 MPa, the deformation is less than 3.5%.

A plastic deformation is minimal up to this pressure load.

Graph 11.2

Surface Pressure, page 1.18

Permissible Surface Speeds

The maximum permissible surface speeds depend on the operating time and the type of movement. A plain bearing is stressed the most during long lasting rotational movements. Here, the maximum speed for iglidur® F plain bearings is 0.8 m/s.

The maximum values given in table 11.2 can only be achieved at the lowest surface pressure. In practice, these limit values are rarely achieved due to varying application conditions.

Surface Speed, page 1.20

p x v value, page 1.22

Temperatures

The ambient temperatures greatly affect the properties of plain bearings. The maximum permissible short term temperature is 180°C. In long-term operations, 140°C may not be exceeded.

With increasing temperatures, the compressive strength of iglidur® F plain bearings decreases. Graph 11.3 shows this relationship. The wear also increases.

☑ Graph 11.3

▶ Application Temperatures, page 1.23

Friction and Wear

The coefficients of friction are not as good for plain bearings made of iglidur® F as they are for the various other iglidur® materials. However, iglidur® plain bearings can be lubricated without reservation. When comparing lubricated iglidur® F bearings with others, iglidur® F plain bearings achieve excellent results.

Friction and wear are, also dependent to a large extent, on the shaft material. It is clear in Graph 11.6 illustrates how shafts that are too smooth increase the coefficient of friction of the bearing. A ground surface with an average roughness greater than $Ra = 0.5 \mu\text{m}$ is best.

☑ Graphs 11.4 to 11.6

▶ Coefficients of Friction and Surfaces, page 1.25

▶ Wear Resistance, page 1.26

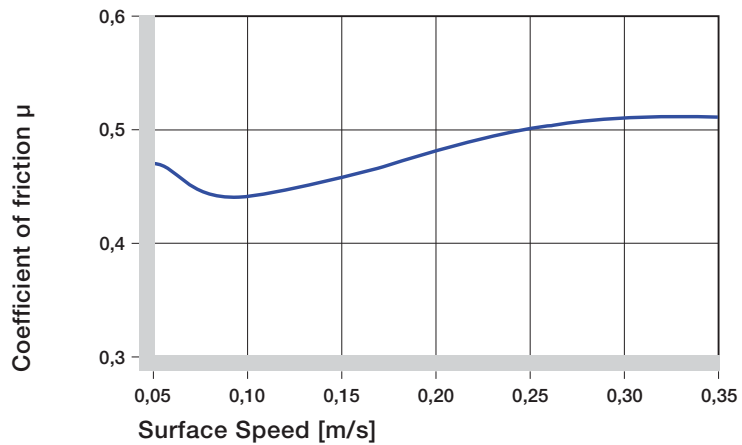

Graph 11.4: Coefficients of friction of iglidur® F as a function of the surface speed; $p = 0.75 \text{ MPa}$

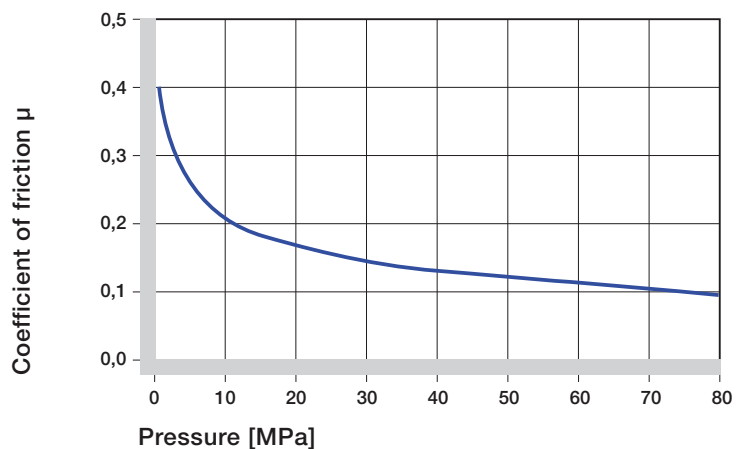

Graph 11.5: Coefficients of friction for iglidur® F as a function of the pressure, $v = 0.01 \text{ m/s}$

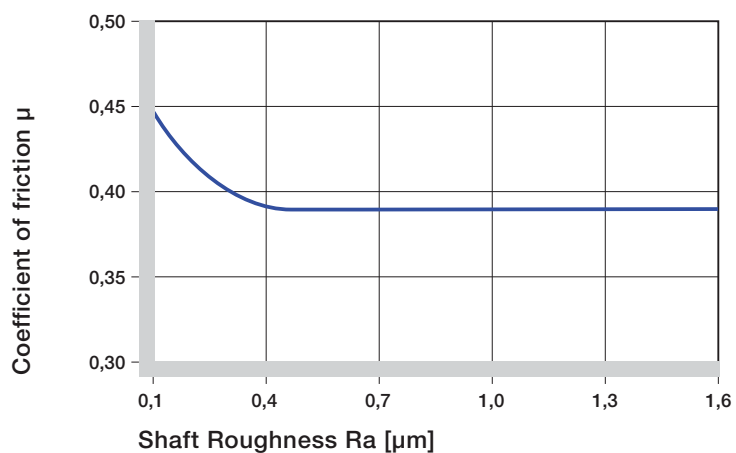

Graph 11.6: Coefficients of friction of iglidur® F as a function of the shaft surface (Cf53 hardened and ground steel)

iglidur® F

Phone +49 - 22 03 - 96 49-145
Fax +49 - 22 03 - 96 49-334

Navigation icons: Home (+), Search (i), Back (←), Forward (→), and a unit indicator (mm).



iglidur® F

Phone +49 - 22 03 - 96 49-145
Fax +49 - 22 03 - 96 49-334

igus® GmbH
51147 Cologne

Internet www.igus.de
E-mail info@igus.de

11.6

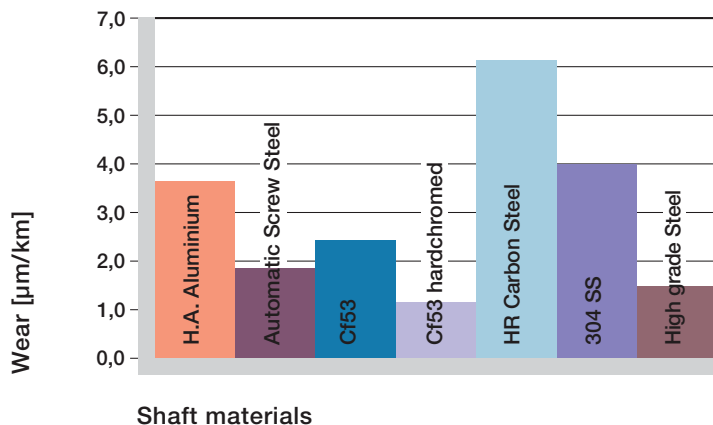

Graph 11.7: Wear of iglidur® F, rotating application with different shaft materials, $p = 0.75 \text{ MPa}$, $v = 0.5 \text{ m/s}$

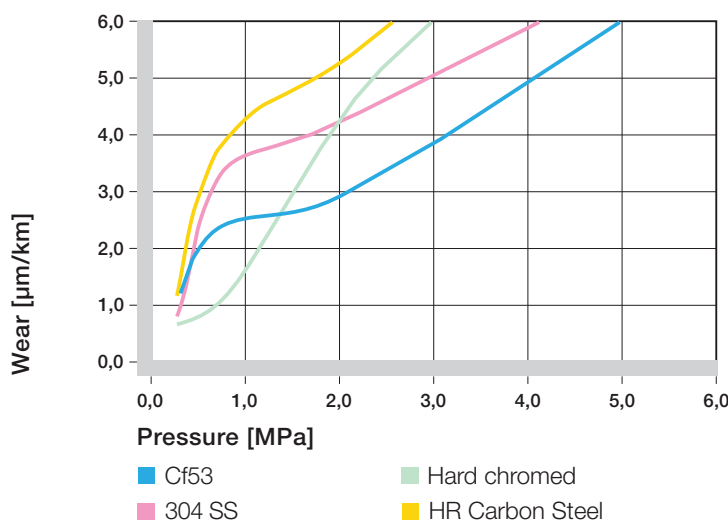

Graph 11.8: Wear of iglidur® F with different shaft materials in rotating applications

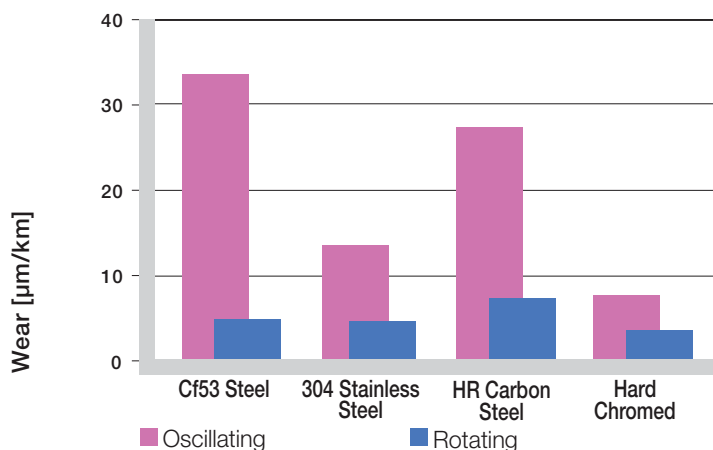

Graph 11.9: Wear of iglidur® F, with different shaft materials, oscillating and rotating, $p = 2 \text{ MPa}$

Shaft Materials

Graphs 11.7 to 11.9 show results of testing different shaft materials with plain bearings made of iglidur® F.

In the lowest load range, the hard chromed shaft proves to be the best partner in rotating applications with iglidur® F plain bearings. The behaviour is different in oscillating movements (see Graph 11.9). With much higher wear values than for rotation, the 303 Stainless Steel shaft and the hard chromed shaft are better than the Cold Rolled Steel shaft even at 2 MPa.

If the shaft material you plan to use is not contained in this list, please contact us.

- Graphs 11.7 to 11.9
- Shaft Materials, page 1.28

Installation Tolerances

iglidur® F plain bearings are meant to be oversized before being pressfit. The bearings are designed for pressfit into a housing machined to a H7 tolerance. After being assembled into a nominal size housing, the inner diameter is adjusted to meet our specified tolerances. Please adhere to the catalog specifications for housing bore and recommended shaft sizes. This will help to ensure optimal performance of iglidur® F plain bearings.

- Testing Methods, page 1.35

Chemical Resistance

iglidur® F plain bearings have a good chemical resistance. They have a high resistance to lubricants, even at high temperatures (around 120°C). Thus iglidur® F plain bearings are especially suitable for applications that must run under lubrication – possibly because of different structural components. iglidur® F is not attacked by most weak organic and inorganic acids. The moisture absorption of iglidur® F plain bearings is approximately 1.8% in standard atmosphere. The saturation limit in water is 8.4%. This must be taken into account along with the other applicable conditions.

- Graph 11.10
- Chemical Table, pages 70.1



Radiation Resistance

Plain bearings made of iglidur® F are resistant to radiation up to an intensity of 3×10^2 Gy.

UV Resistance

iglidur® F plain bearings are permanently resistant to UV radiation.

Vacuum

In a vacuum environment, existing moisture is released as vapour. Therefore, only dehumidified bearings made of iglidur® F are suitable for the vacuum.

Electrical Properties

In contrast to most other iglidur® materials iglidur® F plain bearings are electrically conductive.

Diameter d1 [mm]	Shaft h9 [mm]	iglidur® F D11 [mm]
up to 3	0–0,025	+0,014 +0,054
> 3 to 6	0–0,030	+0,020 +0,068
> 6 to 10	0–0,036	+0,025 +0,083
> 10 to 18	0–0,043	+0,032 +0,102
> 18 to 30	0–0,052	+0,040 +0,124
> 30 to 50	0–0,062	+0,050 +0,150

Table 11.5: Essential tolerances for iglidur® F plain bearings according to ISO 3547-1 after pressfit

Medium	Resistance
Alcohol	+ to 0
Hydrocarbons	+
Greases, oils	
without additives	+
Fuels	+
Diluted acids	0 to –
Strong acids	–
Diluted alkalines	+
Strong alkalines	+ to 0

Table 11.6: Chemical resistance of iglidur® F – detailed list, page 70.1

+ resistant 0 conditionally resistant – not resistant

All data given at room temperature [20°C]

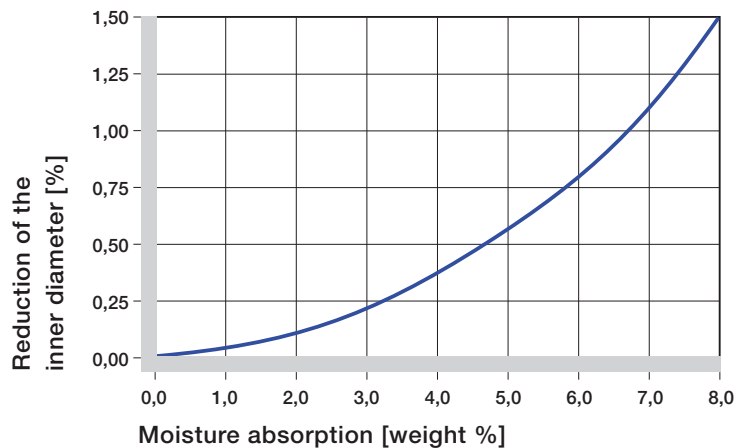

Graph 11.10: Effect of moisture absorption on iglidur® F plain bearings

iglidur® F	
Specific	
volume resistance	> $10^3 \Omega\text{cm}$
Surface resistance	> $10^2 \Omega$

Table 11.7: Electrical properties of iglidur® F

iglidur® F

Phone +49 - 22 03 - 96 49-145
Fax +49 - 22 03 - 96 49-334





iglidur® F | Sleeve Bearing | mm

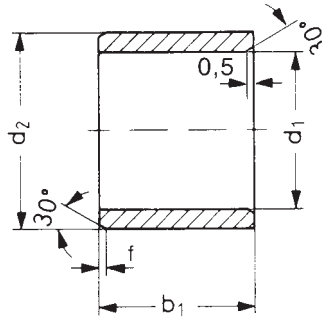

Data in mm

Structure – part no.
F S M-0203-03

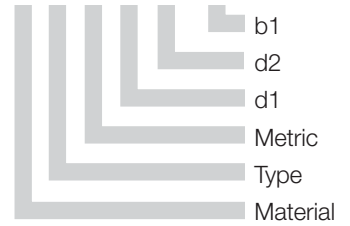

mm

iglidur® F – Type S

Phone +49 - 22 03 - 96 49-145
Fax +49 - 22 03 - 96 49-334

iglus® GmbH
51147 Cologne

Internet www.igus.de
E-mail info@igus.de

Dimensions according to ISO 3547-1
and special dimensions

Chamfer in relation to the d1

d1 [mm]:	Ø 1-6	Ø 6-12	Ø 12-30	Ø > 30
f [mm]:	0,3	0,5	0,8	1,2

Part Number	d1	d1 Tolerance*	d2	b1 h13	Part Number	d1	d1 Tolerance*	d2	b1 h13
FSM-0203-03	2,0	+0,020 +0,080	3,5	3,0	FSM-1820-15	18,0	+0,050 +0,160	20,0	15,0
FSM-0304-03	3,0	+0,020 +0,080	4,5	3,0	FSM-1820-20	18,0	+0,050 +0,160	20,0	20,0
FSM-0405-04	4,0	+0,030 +0,105	5,5	4,0	FSM-2022-14	20,0	+0,065 +0,195	22,0	14,5
FSM-0507-05	5,0	+0,030 +0,105	7,0	5,0	FSM-2022-20	20,0	+0,065 +0,195	22,0	20,0
FSM-0507-08	5,0	+0,030 +0,105	7,0	8,0	FSM-2023-15	20,0	+0,065 +0,195	23,0	15,0
FSM-0608-06	6,0	+0,030 +0,105	8,0	6,0	FSM-2023-20	20,0	+0,065 +0,195	23,0	20,0
FSM-0608-08	6,0	+0,030 +0,105	8,0	8,0	FSM-2225-15	22,0	+0,065 +0,195	25,0	15,0
FSM-0608-10	6,0	+0,030 +0,105	8,0	10,0	FSM-2528-20	25,0	+0,065 +0,195	28,0	20,0
FSM-0608-13	6,0	+0,030 +0,105	8,0	13,8	FSM-2832-20	28,0	+0,065 +0,195	32,0	20,0
FSM-0709-10	7,0	+0,040 +0,130	9,0	10,0	FSM-2832-30	28,0	+0,065 +0,195	32,0	30,0
FSM-0709-12	7,0	+0,040 +0,130	9,0	12,0	FSM-3034-20	30,0	+0,065 +0,195	34,0	20,0
FSM-0810-08	8,0	+0,040 +0,130	10,0	8,0	FSM-3034-30	30,0	+0,065 +0,195	34,0	30,0
FSM-0810-10	8,0	+0,040 +0,130	10,0	10,0	FSM-3034-40	30,0	+0,065 +0,195	34,0	40,0
FSM-0810-15	8,0	+0,040 +0,130	10,0	15,0	FSM-3236-30	32,0	+0,080 +0,240	36,0	30,0
FSM-1012-06	10,0	+0,040 +0,130	12,0	6,0	FSM-3539-30	35,0	+0,080 +0,240	39,0	30,0
FSM-1012-10	10,0	+0,040 +0,130	12,0	10,0	FSM-3539-40	35,0	+0,080 +0,240	39,0	40,0
FSM-1214-10	12,0	+0,050 +0,160	14,0	10,0	FSM-4044-30	40,0	+0,080 +0,240	44,0	30,0
FSM-1214-15	12,0	+0,050 +0,160	14,0	15,0	FSM-4044-50	40,0	+0,080 +0,240	44,0	50,0
FSM-1416-15	14,0	+0,050 +0,160	16,0	15,0	FSM-4550-50	45,0	+0,080 +0,240	50,0	50,0
FSM-1517-15	15,0	+0,050 +0,160	17,0	15,0	FSM-5055-40	50,0	+0,080 +0,240	55,0	40,0
FSM-1517-20	15,0	+0,050 +0,160	17,0	20,0	FSM-5560-50	55,0	+0,100 +0,290	60,0	50,0
FSM-1618-15	16,0	+0,050 +0,160	18,0	15,0	FSM-6065-60	60,0	+0,100 +0,290	65,0	60,0

*after pressfit. Testing methods ► page 1.35

Order example

Our price breaks are defined by the order quantity.

1- 9	25-49	100-199	500- 999	2500-4999
10-24	50-99	200-499	1000-2499	

For the current prices please visit the iglus®-Homepage www.igus.de/en

No minimum order quantities, no surcharges.



Type S



Type F

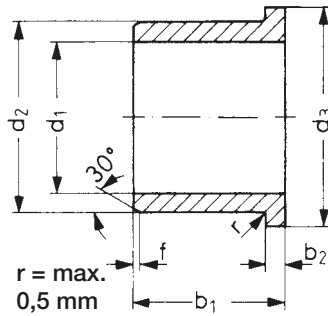

Data in mm

Structure – part no.
F F M-0405-04



Dimensions according to ISO 3547-1 and special dimensions

Chamfer in relation to the d1

d1 [mm]:	Ø 1-6	Ø 6-12	Ø 12-30	Ø > 30
f [mm]:	0,3	0,5	0,8	1,2

Part Number	d1	d1 Tolerance*	d2	d3	b1	b2
FFM-0405-04	4,0	+0,030 +0,105	5,5	9,5	4,0	0,75
FFM-0405-06	4,0	+0,030 +0,105	5,5	9,5	6,0	0,75
FFM-0507-05	5,0	+0,030 +0,105	7,0	11,0	5,0	1,0
FFM-0608-08	6,0	+0,030 +0,105	8,0	12,0	8,0	1,0
FFM-0810-06	8,0	+0,040 +0,130	10,0	15,0	6,0	1,0
FFM-0810-09	8,0	+0,040 +0,130	10,0	15,0	9,0	1,0
FFM-1012-06	10,0	+0,040 +0,130	12,0	18,0	6,0	1,0
FFM-1012-08	10,0	+0,040 +0,130	12,0	15,0	8,0	1,0
FFM-1012-09	10,0	+0,040 +0,130	12,0	18,0	9,0	1,0
FFM-1012-15	10,0	+0,040 +0,130	12,0	18,0	15,0	1,0
FFM-1012-18	10,0	+0,040 +0,130	12,0	18,0	18,0	1,0
FFM-1214-09	12,0	+0,050 +0,160	14,0	20,0	9,0	1,0
FFM-1214-12	12,0	+0,050 +0,160	14,0	20,0	12,0	1,0
FFM-1416-12	14,0	+0,050 +0,160	16,0	22,0	12,0	1,0
FFM-1416-17	14,0	+0,050 +0,160	16,0	22,0	17,0	1,0
FFM-1517-12	15,0	+0,050 +0,160	17,0	23,0	12,0	1,0
FFM-1517-17	15,0	+0,050 +0,160	17,0	23,0	17,0	1,0
FFM-1618-17	16,0	+0,050 +0,160	18,0	24,0	17,0	1,0
FFM-1820-12	18,0	+0,050 +0,160	20,0	26,0	12,0	1,0
FFM-1820-17	18,0	+0,050 +0,160	20,0	26,0	17,0	1,0
FFM-2023-21	20,0	+0,065 +0,195	23,0	30,0	21,0	1,5
FFM-2528-21	25,0	+0,065 +0,195	28,0	35,0	21,0	1,5
FFM-3034-26	30,0	+0,065 +0,195	34,0	42,0	26,0	2,0
FFM-3236-26	32,0	+0,080 +0,240	36,0	45,0	26,0	2,0
FFM-3539-26	35,0	+0,080 +0,240	39,0	47,0	26,0	2,0
FFM-4044-30	40,0	+0,080 +0,240	44,0	52,0	30,0	2,0
FFM-4044-40	40,0	+0,080 +0,240	44,0	52,0	40,0	2,0
FFM-4550-50	45,0	+0,080 +0,240	50,0	58,0	50,0	2,0
FFM-5055-40	50,0	+0,080 +0,240	55,0	63,0	40,0	2,0
FFM-6065-40	60,0	+0,100 +0,290	65,0	73,0	40,0	2,0
FFM-7075-40	70,0	+0,100 +0,290	75,0	83,0	40,0	2,0

*after pressfit. Testing methods ► page 1.35

iglidur® F – Type F

mm

Phone +49 - 22 03 - 96 49-145
Fax +49 - 22 03 - 96 49-334

