

iglidur® H1 – The endurance runner at high temperatures



High wear resistance at high temperatures

Extremely low coefficients of friction

Resistant to splash and steam blasting

For underbonnet applications

iglidur® H1

Phone +49 - 22 03 - 96 49-145
 Fax +49 - 22 03 - 96 49-334

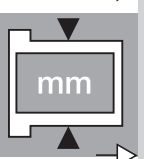
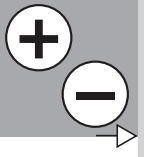

iglidur® H1 is the first choice when service life is required in extreme environmental conditions. Extreme wear resistance is coupled with excellent resistance to temperature and chemicals - not only in the packaging and food industries or the automotive industry.

iglidur® H1

2 styles
> 12 dimensions
Ø 6-20 mm



Phone +49 - 22 03 - 96 49-145
Fax +49 - 22 03 - 96 49-334

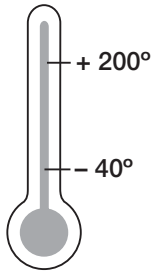

igus® GmbH
51147 Cologne

Price index



Resistant to extreme conditions



When to use iglidur® H1 plain bearings?

- When extreme service life is required under the influence of temperature and humidity
- When low coefficients of friction at high temperature are important
- When regular aggressive cleaning is required (splashes, steam blasting)

When not to use them?

- When the best universal chemical resistance is required
▶ iglidur® X (chapter 6)
- When a cost-efficient high temperature bearing is sought, not the ideal wear resistance
▶ iglidur® H2 (chapter 27)
- When an FDA-compliant plain bearing with high temperature resistance is required
▶ iglidur® A500 (chapter 10)

Internet www.igus.de
E-mail info@igus.de

Material Table

General Properties	Unit	iglidur® H1	Testing Method
Density	g/cm ³	1,53	
Colour		cream	
Max. moisture absorption at 23°C / 50% r.F.	% weight	0,1	DIN 53495
Max. moisture absorption	% weight	0,3	
Coefficient of sliding friction, dynamic against steel	μ		0,06 - 0,20
p x v value, max. (dry)	MPa x m/s	0,8	
Mechanical Properties			
Modulus of elasticity	MPa	2800	DIN 53457
Tensile strength at 20°C	MPa	55	DIN 53452
Compressive strength	MPa	78	
Max. recommended surface pressure (20°C)	MPa	80	
Shore D hardness		77	DIN 53505
Physical and Thermal Properties			
Max. long term application temperature	°C	200	
Max. short term application temperature	°C	240	
Min. application temperature	°C	-40	
Thermal conductivity	W/m x K	0,24	ASTM C 177
Coefficient of thermal expansion (at 23°C)	K ⁻¹ x 10 ⁻⁵	6	DIN 53752
Electrical Properties			
Specific volume resistance	Ωcm	> 10 ¹²	DIN IEC 93
Surface resistance	Ω	> 10 ¹¹	DIN 53482

Table 13.1: Material Data

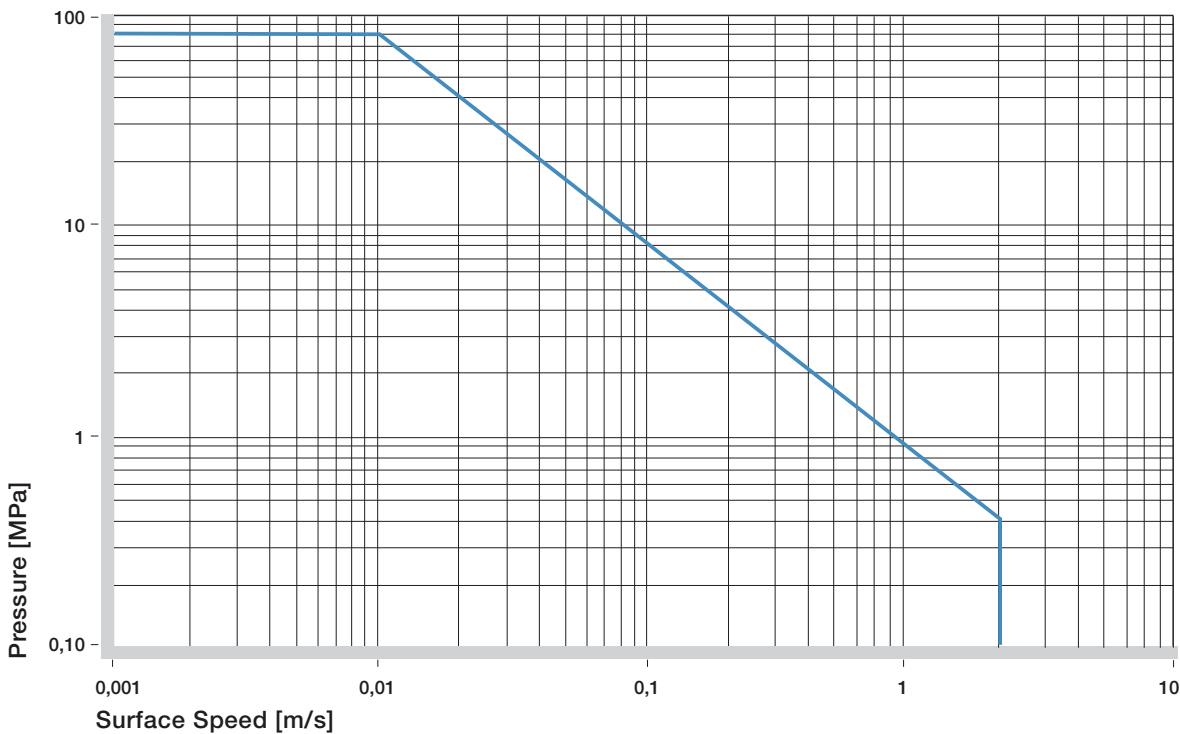

Graph 13.1: Permissible p x v value for iglidur® H1 running dry against a steel shaft, at 20°C

iglidur® H1

Phone +49 - 22 03 - 96 49-145
 Fax +49 - 22 03 - 96 49-334

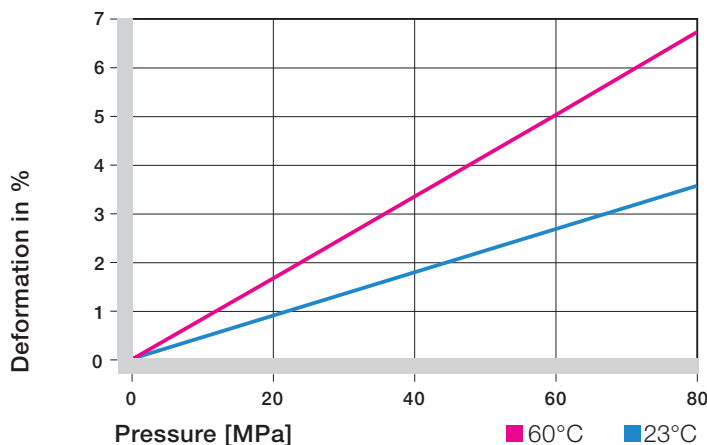

Graph 13.2: Deformation under pressure and temperature

m/s	Rotating	Oscillating	Linear
Continuous	2	1,0	5
Short term	2,5	1,5	7

Table 13.2: Maximum surface speeds

iglidur® H1	Application Temperature
Minimum	-40 °C
Max. long term	+200 °C
Max. short term	+240 °C

Table 13.3: Temperature limits for iglidur® H1

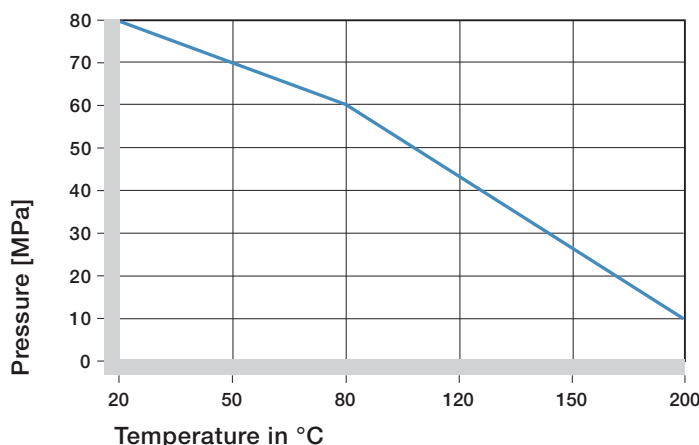

Graph 13.3: Recommended maximum surface pressure of iglidur® H1 as a function of temperature

iglidur® H1 plain bearings have been specially developed for use under extreme environmental conditions. Its strengths are extremely high wear resistance and excellent coefficients of friction even in applications where the bearings are exposed to high temperatures and/or aggressive chemicals media. iglidur® H1 plain bearings can be used entirely free of lubricants; in wet area applications the surrounding medium can act as additional lubricant.

Surface pressure

Figure 13.2 shows the elastic deformation of iglidur® H1 with radial loads. Among the iglidur® H materials, iglidur® H1 has the greatest elasticity. This is beneficial in applications with edge loads and is the reason for a higher mechanical loss factor that indicates the vibration dampening capacity of a material.

Figure 13.2

► Surface pressure, page 1.20

Admissible surface speeds

Due to the excellent coefficients of friction, rotating surface speeds up to 2 m/s are possible with iglidur® H1 plain bearings in dry operation. Linear speeds up to 5 m/s can be attained. The speeds stated in Table 13.2 are limit values for the lowest bearing loads. With higher loads, the permitted speed drops with the extent of an increase in load due to the limitations given by the $p \times v$ value.

► Surface Speed, page 1.22

► $p \times v$ value, page 1.24

Temperatures

iglidur® H1 is a temperature-resistant material. The short-term permitted maximum temperature is 240° C, and this enables the iglidur® H1 bearings to be used, for instance, in a paint drying process without further load. However the compressive strength of iglidur® H1 plain bearings decrease with increasing temperatures. Figure 13.3 clarifies this relationship. As well as the ambient temperatures, the additional frictional heat in the bearing system must be considered. The temperatures prevailing in the bearing system also have an influence on the bearing wear. The wear rises with increasing temperatures.

☑ Figure 13.3 and 13.4

▶ Application Temperatures, page 1.25

Friction and wear

The coefficient of friction alters in the same way as the wear resistance with increasing load and wear. At constant load the coefficient of friction μ increases with the speed. At constant speed the coefficient of friction reduces with increasing load, and then almost constant values result from 40 MPa onwards. As the counter sliding surface has a large influence on friction and wear, the choice of the appropriate shaft can be decisive. Smoother shafts than $R_a = 0.1 \mu\text{m}$ raise the coefficient of friction. For applications with high loads, we recommend hardened and smoothed surfaces with an average surface finish of $R_a = 0.3$ to $0.4 \mu\text{m}$.

☑ Graphs 13.5 to 13.7

▶ Coefficients of Friction and Surfaces, page 1.27

▶ Wear Resistance, page 1.28

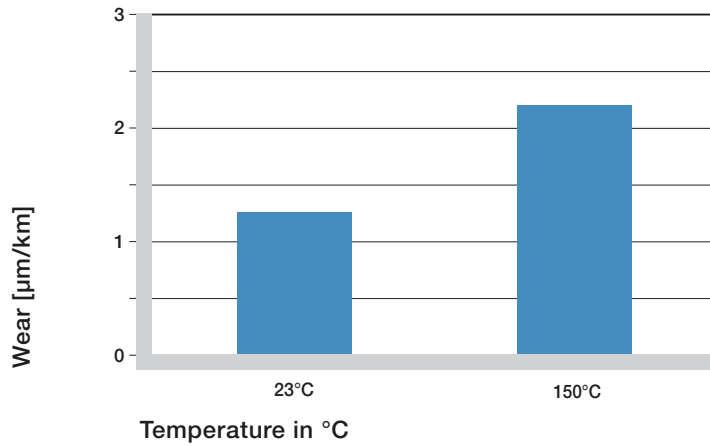

Graph 13.4: Wear of iglidur® H1, rotation with $p = 2 \text{ MPa}$, $v = 0.3 \text{ m/s}$, as a function of temperature (Cf53 shaft)

iglidur® H1	Dry	Grease	Oil	Water
C.o.f. [μ]	0,06–0,20	0,09	0,04	0,04

Table 13.4: Coefficient of friction for iglidur® H1 against steel ($R_a = 1 \mu\text{m}$, 50 HRC)

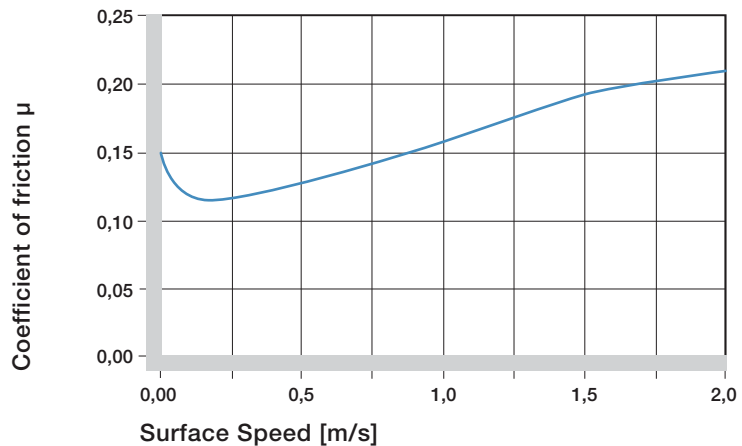

Graph 13.5: Coefficients of friction for iglidur® H1 as a function of the surface speed; $p = 0.75 \text{ MPa}$, shaft Cf53, rotating

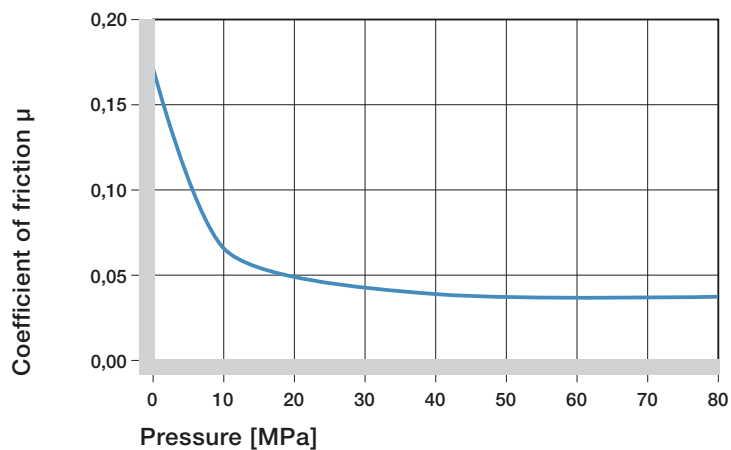

Graph 13.6: Coefficients of friction for iglidur® H1 as a function of the pressure, $v = 0.01 \text{ m/s}$, shaft Cf53, rotating

iglidur® H1

Phone +49 - 22 03 - 96 49-145
 Fax +49 - 22 03 - 96 49-334

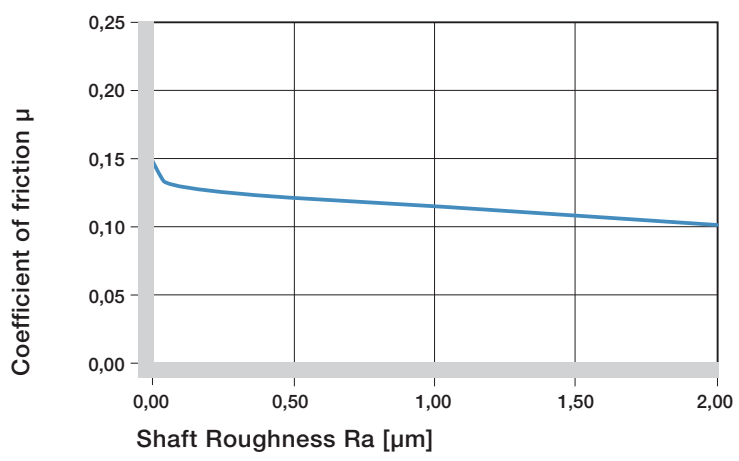

Graph 13.7: Coefficients of friction of iglidur® H1 as a function of the shaft surface, Shaft Cf53

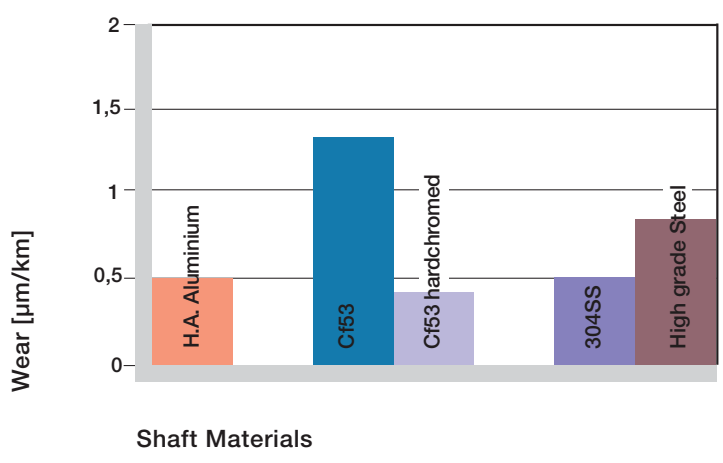

Graph 13.8: Wear of iglidur® H1, rotating application with different shaft materials, $p = 2 \text{ MPa}$, $v = 0,3 \text{ m/s}$

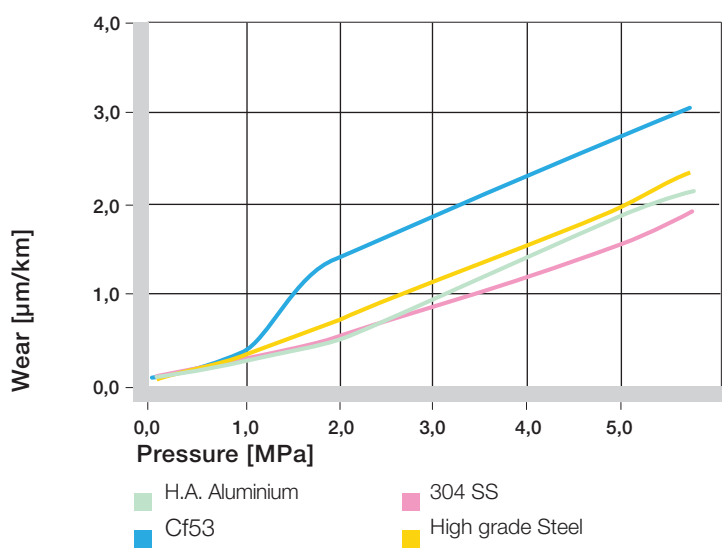

Graph 13.9: Wear of iglidur® H1 with different shaft materials in rotating applications

Shaft materials

Figure 13.8 displays a summary of the results of tests with different shaft materials conducted with iglidur® H1 plain bearings in the igus® laboratory. iglidur® H1 bearings display a distinctly different behaviour with different shaft materials in rotating and pivoting applications. In rotating applications, the X90 and V2A shafts are superior to the aluminum HC and Cf53 shafts especially with high loads. In pivoting applications, the lowest wear rates were measured with aluminum HC and V2A shafts. With most shafts, the rotation wear rates are somewhat lower than the pivoting wear rates. Please contact us in case if your shaft material is not included in this diagram.

Graph 13.8 to 13.10

Installation tolerances

igidur® H1 bearings are press-in bearings for shafts with h-tolerance (recommended minimum h9). The bearings are designed for press-fit into a housing with H7 tolerance. After the installation in a housing with a nominal diameter, the inner diameter of the bearing automatically adjusts to the F10 tolerance.

Testing Methods, page 1.35

Chemical resistance

iglidur® H1 bearings have a good chemical resistance and chemicals can even act as lubricants. The iglidur® H1 plain bearings are not resistant against hot, oxidizing acids and some other particularly aggressive chemicals. The moisture absorption of iglidur® H1 bearings is approximately 0.1% in standard climatic conditions. The saturation limit in water is 0.3%. Therefore iglidur® H1 is very well suited for use in wet environments.

► Chemical Table, page. 70.1

UV-resistance

igubal® H1 bearings are only conditionally resistant to UV rays. The surface of iglidur® H1 becomes coarser and the wear increases under the influence of atmospheric conditions.

Vacuum

Note that for use in vacuum, water elements, even if only minimal, should be degassed.

Electrical properties

iglidur® H1 bearings are electrically insulating.

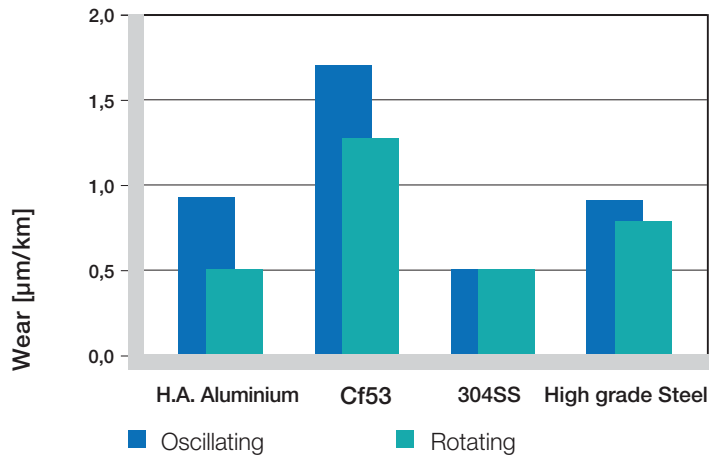

Graph 13.10: Wear with different shaft materials, oscillating and rotating applications, p = 2 MPa

Diameter d1 [mm]	Shaft h9 [mm]	iglidur® H1 F10 [mm]
to 3	0-0,025	+0,006 +0,046
> 3 to 6	0-0,030	+0,010 +0,058
> 6 to 10	0-0,036	+0,013 +0,071
> 10 to 18	0-0,043	+0,016 +0,086
> 18 to 30	0-0,052	+0,020 +0,104
> 30 to 50	0-0,062	+0,025 +0,125
> 50 to 80	0-0,074	+0,030 +0,150

Table 13.5: Essential tolerances for iglidur® H1 plain bearings according to ISO 3547-1 after pressfit

Medium	Resistance
Alcohol	+
Hydrocarbons	+
Greases, oils	
without additives	+
Fuels	+
Diluted acids	+ to 0
Strong acids	+ to -
Diluted alkalines	+
Strong alkalines	+ to -

Table 13.6: Chemical resistance of iglidur® H1 – detailed list, page 70.1

+ resistant 0 conditionally resistant - not resistant
All data given at room temperature [20°C]

iglidur® H1	
Specific	
volume resistance	> 10 ¹² Ωcm
Surface resistance	> 10 ¹¹ Ω

Table 13.7: Electrical properties of iglidur® H1

iglidur® H1

Phone +49 - 22 03 - 96 49-145
Fax +49 - 22 03 - 96 49-334



iglidur® H1 | Sleeve Bearing | mm

mm

iglidur® H1 – Type S

Phone +49 - 22 03 - 96 49-145
Fax +49 - 22 03 - 96 49-334

igus® GmbH
51147 Cologne

Internet www.igus.de
E-mail info@igus.de

13.8

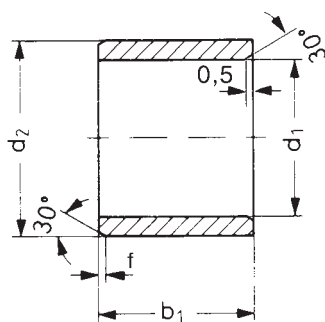

Data in mm

Structure – part no.:
H1 S M-0608-06



Chamfer in relation to the d1

d1 [mm]:	Ø 1-6	Ø 6-12	Ø 12-30	Ø > 30
f [mm]:	0,3	0,5	0,8	1,2

Dimensions according to ISO 3547-1
and special dimensions

Part Number	d1	d1 Tolerance*	d2	b1
				h13
H1SM-0608-06	6,0	+0,010 +0,058	8,0	6,0
H1SM-0810-10	8,0	+0,013 +0,071	10,0	10,0
H1SM-1012-10	10,0	+0,013 +0,071	12,0	10,0
H1SM-1214-12	12,0	+0,016 +0,086	14,0	12,0
H1SM-1618-15	16,0	+0,016 +0,086	18,0	15,0
H1SM-2023-20	20,0	+0,020 +0,104	23,0	20,0

*after pressfit. Testing methods ► Page 1.35

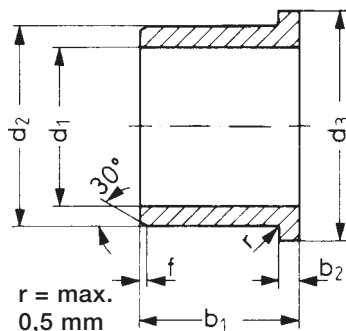

Data in mm

Structure - part no.:
H1 F M-0608-06



Chamfer in relation to the d1

d1 [mm]:	Ø 1-6	Ø 6-12	Ø 12-30	Ø > 30
f [mm]:	0,3	0,5	0,8	1,2

Dimensions according to ISO 3547-1 and special dimensions

Part Number	d1	d1 Tolerance*	d2	d3	b1	b2
H1FM-0608-06	6,0	+0,010 +0,058	8,0	12,0	6,0	1,0
H1FM-0810-10	8,0	+0,013 +0,071	10,0	15,0	10,0	1,0
H1FM-1012-10	10,0	+0,013 +0,071	12,0	18,0	10,0	1,0
H1FM-1214-12	12,0	+0,016 +0,086	14,0	20,0	12,0	1,0
H1FM-1618-17	16,0	+0,016 +0,086	18,0	24,0	17,0	1,0
H1FM-2023-21	20,0	+0,020 +0,104	23,0	30,0	21,5	1,5

*after pressfit. Testing methods ► Page 1.35

iglidur® H1 - Type F

mm

Phone +49 - 22 03 - 96 49-145
Fax +49 - 22 03 - 96 49-334

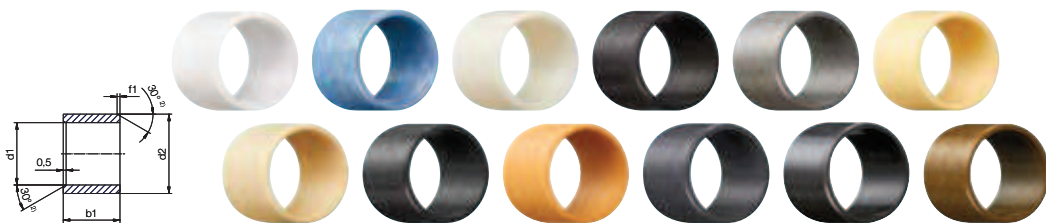

Dimensions sleeve Abmessungen zylindrisch [mm]

Part No. Art.-Nr.	d1	d1 tolerance d1-Toleranz	d2	b1 h13
A180SM-0810-15	8.0	+0.025 +0.083	10.0	15.0
A350SM-1416-12	14.0	+0.016 +0.068	16.0	12.0
C500SM-3034-30	30.0	+0.020 +0.104	34.0	30.0
F2SM-1214-15	12.0	+0.032 +0.102	14.0	15.0
F2SM-1618-20	16.0	+0.032 +0.102	18.0	20.0
GSM-0406-06	4.0	+0.020 +0.068	6.0	6.0
GSM-0810-36	8.0	+0.025 +0.083	10.0	36.0
GSM-120125-78	120.0	+0.072 +0.212	125.0	78.0
GSM-1214-45	12.0	+0.032 +0.102	14.0	45.0
GSM-1820-30	18.0	+0.032 +0.102	20.0	30.0
GSM-1822-15	18.0	+0.032 +0.102	22.0	15.0
GSM-2021-095	20.0	+0.020 +0.072	21.0	9.5
JSM-0814-08	8.0	+0.040 +0.130	14.0	8.0
JSM-1216-06	12.0	+0.050 +0.0160	16.0	6.0
JSM-1218-10	12.0	+0.050 +0.0160	18.0	10.0
JSM-1315-06	13.0	+0.050 +0.0160	15.0	6.0
JSM-1620-20	16.0	+0.050 +0.0160	20.0	20.0
JSM-6065-100	60.0	+0.060 +0.180	65.0	100.0
MSM-1620-10	16.0	+0.050 +0.0160	20.0	10.0
P210SM-1214-04	12.0	+0.032 +0.102	14.0	4.0
PSM-0608-05	6.0	+0.020 +0.068	8.0	5.0
PSM-0812-10	8.0	+0.040 +0.130	12.0	10.0
PSM-3236-15	32.0	+0.050 +0.150	36.0	15.0
Q2SM-1012-04	10.0	+0.025 +0.083	12.0	4.0
Q2SM-4246-52	42.0	+0.050 +0.150	46.0	52.0
X6SM-1416-22	14.0	+0.016 +0.086	16.0	22.0
X6SM-1618-12	16.0	+0.016 +0.086	18.0	12.0
X6SM-2023-15	20.0	+0.020 +0.104	23.0	15.0
ZSM-2225-35	22.0	+0.020 +0.104	25.0	35.0
ZSM-6065-25	60.0	+0.030 +0.150	65.0	25.0
ZSM-9095-100	90.0	+0.036 +0.176	95.0	100.0

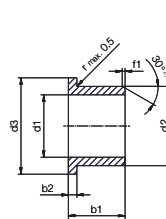

Dimensions with flange Abmessungen mit Bund [mm]

Part No. Art.-Nr.	d1	d1 tolerance d1-Toleranz	d2	d3	b1 h13	b2
GFM-060710-06	6.0	+0.010 +0.040	7.0	10.0	6.0	0.5
GFM-0812-16	8.0	+0.040 +0.130	12.0	16.0	16.0	2.0
GFM-101115-03	10.0	+0.013 +0.046	11.0	15.0	3.0	1.0
GFM-1012-11	10.0	+0.025 +0.083	12.0	18.0	11.0	1.0
GFM-1012-25	10.0	+0.025 +0.083	12.0	18.0	25.0	1.0
GFM-1719-07	17.0	+0.032 +0.102	19.0	25.0	7.0	1.0
GFM-2527-12	25.0	+0.040 +0.124	27.0	32.0	12.0	1.0
GFM-2527-15	25.0	+0.040 +0.124	27.0	32.0	15.0	1.0
GFM-3034-12	30.0	+0.040 +0.124	34.0	42.0	12.0	2.0
GFM-303440-07	30.0	+0.040 +0.124	34.0	40.0	7.0	2.0
H1FM-0405-06	4.0	+0.010 +0.058	5.5	9.5	6.0	0.8
J350FM-6065-50	60.0	+0.030 +0.150	65.0	73.0	50.0	2.0
J3FM-081418-15	8.0	+0.025 +0.083	14.0	18.0	15.0	2.0
JFM-040810-15	4.0	+0.020 +0.068	8.0	10.0	15.0	2.0
JFM-0810-03	8.0	+0.025 +0.083	10.0	15.0	3.0	1.0
JFM-121419-06	12.0	+0.032 +0.102	14.0	19.0	6.0	1.0
JFM-121622-20	12.0	+0.050 +0.0160	16.0	22.0	20.0	2.0
JFM-2023-07	20.0	+0.040 +0.124	23.0	30.0	7.0	1.5
PFM-1214-08	12.0	+0.032 +0.102	14.0	8.0	20.0	1.0
PFM-1618-08	16.0	+0.032 +0.102	18.0	8.0	24.0	1.0
P210FM-0405-06	4.0	+0.020 +0.068	5.5	9.5	6.0	0.8
Q290FM-8085-100	80.0	+0.060 +0.180	85.0	93.0	100.0	2.5
Q2FM-101219-13	10.0	+0.025 +0.083	12.0	19.0	13.0	1.0
Q2FM-1013-05	10.0	+0.025 +0.083	13.0	20.0	5.0	1.0
Q2FM-2023-07	20.0	+0.040 +0.124	23.0	30.0	7.0	1.5
QFM-101215-04	10.0	+0.025 +0.083	12.0	15.0	4.0	1.0
QFM-121418-06	12.0	+0.032 +0.102	14.0	18.0	6.0	1.0
WFM-2023-08	20.0	+0.040 +0.124	23.0	30.0	8.0	1.5
XFM-1214-50	12.0	+0.016 +0.086	14.0	50.0	20.0	1.0
X6FM-0608-04	6.0	+0.010 +0.058	8.0	12.0	4.0	1.0
ZFM-1012-25	10.0	+0.013 +0.071	12.0	18.0	25.0	1.0
ZFM-2023-075	20.0	+0.020 +0.104	23.0	30.0	7.5	1.5

Calculate online Online berechenbar
www.igus.eu/iglidur-experte
www.igus.de/iglidur-expert

Available Lieferbar
 from stock ab Lager

www.igus.de/iglidur
www.igus.eu/iglidur

Calculate online Online berechenbar
www.igus.eu/iglidur-experte
www.igus.de/iglidur-expert

Available Lieferbar
 from stock ab Lager

www.igus.de/iglidur
www.igus.eu/iglidur