

# Making Product & CAD Selection Fast & Easy for Customers



CAD to Reality

Presenter: Bruce Hamper  
Marketing Director

# What We Do

- Power Jacks is an engineering company focused on providing customers with the best lifting & positioning solutions for applications in Industrial Automation, Energy, Defence, Medical, Transport, and the Civil Engineering sectors
- UK's Largest Manufacturer of
  - screw jacks,
  - electric linear actuators,
  - spiral bevel gearboxes,
  - jacking systems
  - planetary roller screws,
- Engineering service across our entire range of products that means customers get exactly what they need.
- Products are supplied globally as individual units or as complete motion systems.



# History of Power Jacks

- 1988 – Power Jacks Ltd Starts
- 2002- Power Jacks Group
  - Power Jacks Acquire: Precision Actuation Systems, Neeter Drive, Fortune Engineering and Youngs Lifting.
- 2009 – Power Jacks China Sales Office Opens in Shanghai
- 2010 – Power Jacks Wins Queen’s Award for International Trade
  - Power Jacks’ award marks the company’s considerable global growth with overseas sales increasing by 246%.
- 2011 – Ellon HQ & Factory Opened
  - Power Jacks multi-million pound headquarters.



# History of Power Jacks

- 2016 – New Power Jacks GmbH
  - New German Sales Office Opens in Wangen im Allgäu Southern Germany
- 2017 – New Midlands Office
  - New UK Business Development Office Opens in Birmingham
- 2017 – New Power Jacks (India) Pvt Ltd
  - New India Sales Office Opens Vadodara in Gujarat province in India
- 2018 Power Jacks Ltd Celebrates 30 Years of Business.



# Facilities

- Modern Manufacturing facility
  - CAD/CAM/CAE design and manufacture
  - Advanced ERP computer system
  - State of the Art CNC Machining
  - Team of 60 highly trained people.



- Quality
  - Quality BS EN ISO 9001
  - Health & Safety OHSAS 18001
  - Environmentally friendly ISO 14001

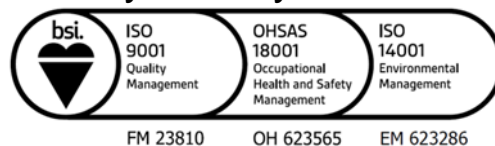

- Philosophy
  - Quality products that offer reliability, performance and value for money.
  - Unsurpassed experience of linear motion products, their applications & our ability to engineer special products to give our customers an advantage.

# Global Sales Network



A network of 30 distributors around the world and customers in 80 countries.

tel: +44 (0) 1358 285100

email: [sales@powerjacks.com](mailto:sales@powerjacks.com)

web: [www.powerjacks.com](http://www.powerjacks.com)

# www.powerjacks.com a Global Engineering Resource

- Info 24/7 365 days/year
  - 3D & 2D CAD Models
  - Brochures & Datasheets
  - Maintenance Manuals
  - Answers to FAQs
  - Application examples
  - Send RFQs & Enquiries



- 3D Product Configurator & Selector
  - Configure, view and download CAD models in 3D or 2D in over 30 different formats.
  - Engineers can quickly and easily put the exact model into their assembly.
  - Use the Product Selector to recommend a product when you don't know what to choose or how to choose it.
  - Request a quote for the model you've configured or selected.

# Products - Overview

Designed & Manufactured by Power Jacks



**Screw Jacks**



**Screw Jack Systems**



**Bevel Gearboxes**



**Linear Actuators**

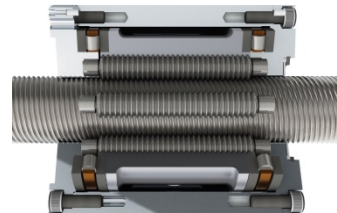

**Planetary Roller Screws**



**Load Monitoring**



# Products - Screw Jacks

- Machine Screw Jacks
- Ball Screw Jacks
- Roller Screw Jacks
  
- Single Face Design (E-Series)
- Cubic Design (C-Series)
- Stainless Steel Design (E-Series version)
- Subsea Design (U-Series)
  
- Capacities 5kN – 2000kN (0.5Te – 200Te) as Standard
- Capacities up to 35000kN (3500Te) on request
- Translating screw designs
- Rotating screw designs.
  
- Special designs available.



# Products – Jacking Systems

- Connect Screw Jacks in systems so multiple units can be operated & controlled together.
- Jacking system configurations can be built in many formats with the use of bevel gearboxes, motors, reduction gearboxes, drive shafts, couplings, plummer blocks and motion control devices.

H-Configuration



U-Configuration



T-Configuration



I-Configuration



## Products – Electric Linear Actuators

- Machine Screw Actuators
- Ball Screw Actuators
- Roller Screw Actuators
  
- Motor mounted Parallel to ram
- Motor mounted In-Line with ram
- Motor mounted 90° to ram
  
- Capacities up to 400kN (40Te) as Standard
- Capacities up to 1000kN (100Te) on request
- Linear Speeds up to 7000 mm/min as standard
- Linear Speeds up to 50,000 mm/min on request
  
- Special Designs Available, including full stainless steel.

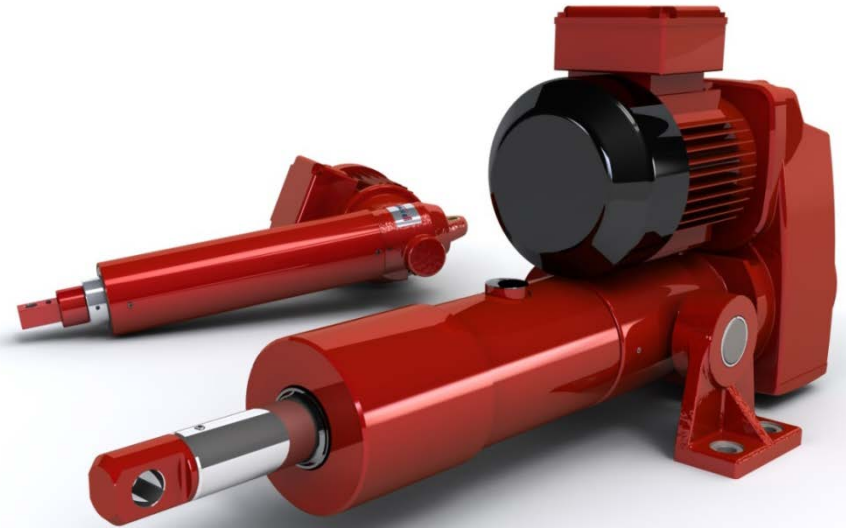

## Products - Bevel Gearboxes

- Solid Shaft
- Hollow Shaft
- 2-way, 3-way, 4-way
  
- Ultra-Compact Design (Range-N)
- Subsea Design (Range-U)
- Monobloc Design (Range-P)
  
- Gear Ratios 1:1, 1.5:1, 2:1, 3:1 and 4:1
- Torque Rating to 7000Nm as standard
- Torque Rating to 20,000Nm on request
  
- Special Designs Available, including full stainless steel.



# Products – In Motion

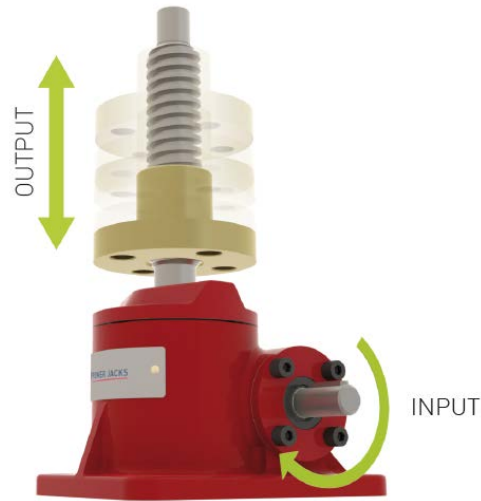

Screw Jacks  
Input: Rotary Motion & Torque  
Output: Linear Motion & Force

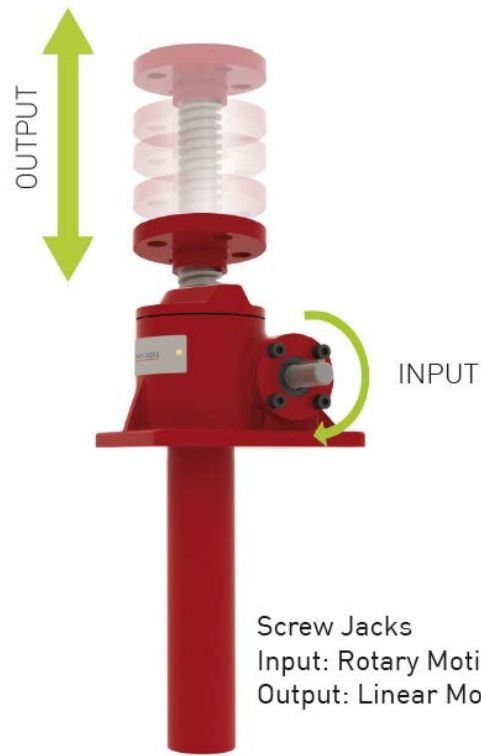

Screw Jacks  
Input: Rotary Motion & Torque  
Output: Linear Motion & Force

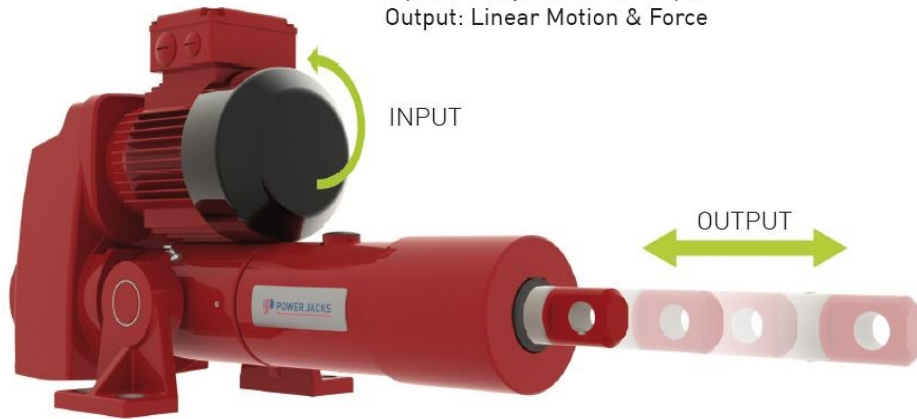

Linear Actuator  
Input: Rotary Motion & Torque  
Output: Linear Motion & Force



Bevel Gearbox  
Input: Rotary Motion & Torque  
Output: Rotary Motion & Torque

# Products – Typical Automation

○ Tilt / Pivot

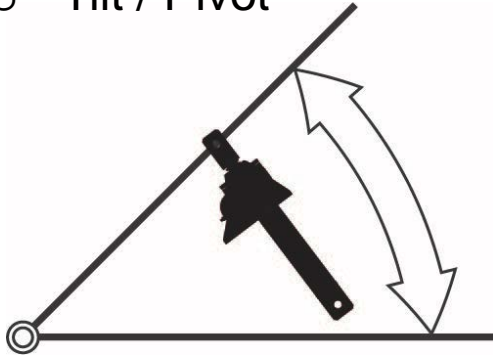

○ Position

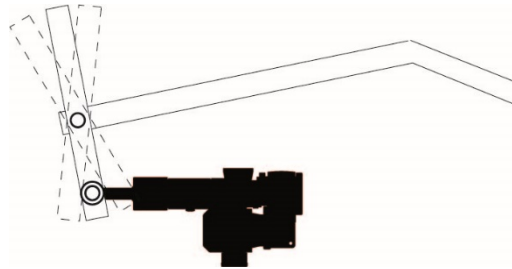

○ Open / Close

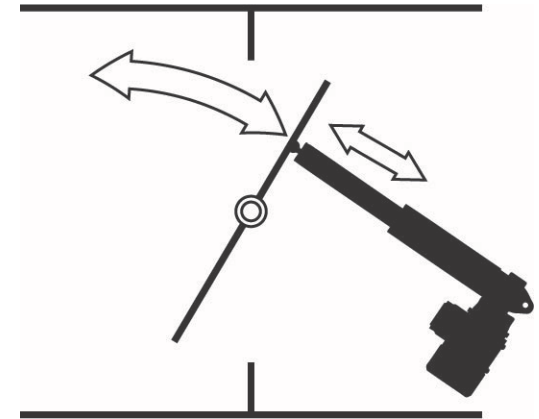

○ Lift / Lower

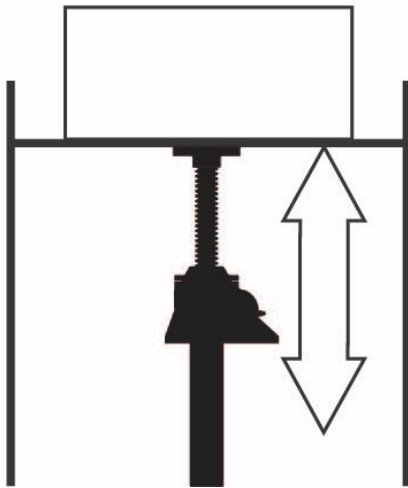

○ Roll / Slide

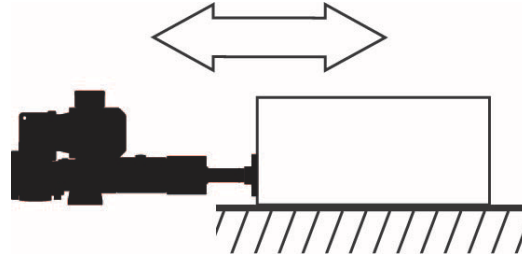

○ Tension

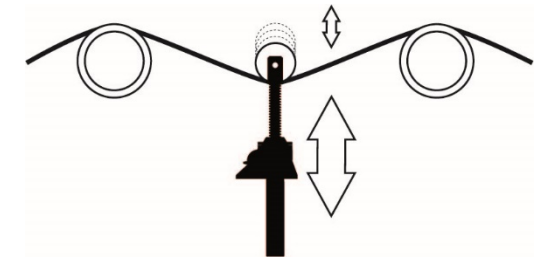

○ Lock / Unlock

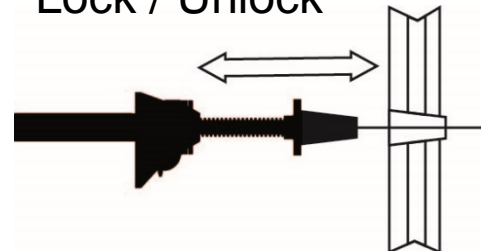

# Applications – Example Overview

**Steel**  
Heavy Plate Steel



**Beverage Can**  
Can Wash Automation

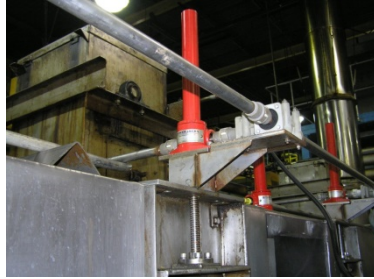

**Nuclear Research**  
Neutron-Target Door

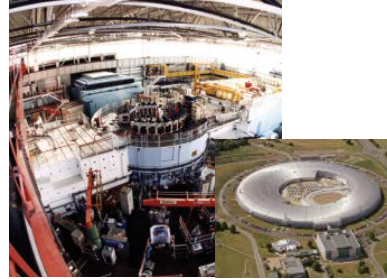

**Metal Processing**  
Straightening Machine



**Satcom**  
Elevation & Azimuth



**Flood Defence**  
Bridge Automation



**Automotive**  
Suspension Testing



**Railway**  
Maglev Points Control



**Agriculture**  
Compost Roof Lift



**Aerospace**  
Maintenance Platform



**Stadium**  
Wimbledon Roof



**Oil & Gas**  
Subsea Riser Positioning



# Website - Generating Interest & Understanding

## Traditional

- Product Detail with 3D CAD Renders of Products
- Product FAQs
- Application Examples
- Downloads including Brochures & Datasheets
- Videos to watch

## NEW

- Interactive 3D Preview of Product using CADENAS<sup>®</sup>
  - NO portal registration required.
  - 3D Preview on product content web page.
  - View an example product from all angles.
  - Increases product knowledge.
  - Increases familiarity with CADENAS viewer.





# 3D Visualisation For All

- 3D Product Preview Visualisation via Web Pages and NOT via a Portal.

The screenshot shows the Powerjacks website interface. At the top, there is a navigation bar with links for 'Login', 'Configure CAD', 'Select Products', 'Contact Us', and 'Language (EN)'. Below this is a red header with 'POWER JACKS' and 'Lifting and Positioning Solutions' logo, along with contact information for UK and Germany. A secondary navigation bar lists categories like 'ABOUT US', 'PRODUCTS', 'DOWNLOADS & VIDEOS', etc. The main content area features a 'Metric Machine Screw Jack' section with icons for different configurations: Rotating, Translating, Translating with Anti-Backlash, and Translating with Anti-Rotation. A 'Screw Jack Product Selector' section is also visible. On the right, there are sections for 'Downloads', 'Brochures', 'Reference Guides', and 'Forms'. A large blue arrow points from the product selector area towards the right, indicating a transition to a detailed preview.

This screenshot shows a detailed 3D preview of a red screw jack, Model 25kN. The central image displays the jack with the 'POWER JACKS' logo. To the right of the image is a 'Switch Preview' menu with the following options: Upright, Translating; Upright, Rotating; Upright, Translating with Anti-Backlash; Upright, Translating with Anti-Rotation; Upright, Translating with Anti-Backlash & Anti-Rotation; Inverted, Translating; Inverted, Rotating; Inverted, Translating with Anti-Backlash; Inverted, Translating with Anti-Rotation; and Inverted, Translating with Anti-Backlash & Anti-Rotation. Below the 3D model are icons for different views: top, bottom, left, right, front, back, and a 3D view. At the bottom of the preview area, there is a footer with 'powered by CADENAS | Legal notice | Data privacy policy | Tracking Policy | DE-113 |'.

Deep Links with Portlet Configuration

# Portal - Access

- Access via Power Jacks or PARTcommunity Portals

The image displays two web portals. The top portal is the Power Jacks website, featuring a navigation menu with options like 'ABOUT US', 'PRODUCTS', 'DOWNLOADS & VIDEOS', 'INDUSTRIES', 'NEWS & EVENTS', 'WHERE TO BUY', and 'SUPPORT'. It also includes a search bar and contact information for UK sales and Vertrieb. The bottom portal is the PARTcommunity interface, which is a 3D CAD Catalogs & Models portal. It shows a user dashboard for 'Bruce' with a profile section and an engineering section. The engineering section includes a 3D CAD configurator and product selector. The main content area displays five product categories: Screw Jacks, Bevel Gearboxes, Linear Actuators, Load Monitoring, and Copyright. Each category has a representative image and a date.

**POWER JACKS**  
Lifting and Positioning Solutions

Users ▾ Configure CAD Select Product Contact Us ▾ Change Region

Search

CALL UK SALES: +44 (0)1358 285100  
VERTRIEB: +49 (0)7522 7892642

ABOUT US ▾ PRODUCTS ▾ DOWNLOADS & VIDEOS ▾ INDUSTRIES ▾ NEWS & EVENTS WHERE TO BUY SUPPORT ▾

Dashboard

**Dashboard**

Hello Bruce, you last logged in on 05-02-2018.

**Profile**

Manage your personal details

Update security settings

**Engineering**

3D CAD configurator and product selector.

CAD configurator  
 Product selector

**PARTcommunity** 3D CAD Catalogs & Models

COMMUNITY 3D CAD CATALOGS PDF CATALOGS 3D SHARE

3D CAD Catalogs

**POWER JACKS LTD**  
POWER JACKS LTD

**Screw Jacks**  
14.12.2016

**Bevel Gearboxes**  
17.01.2017

**Linear Actuators**  
19.12.2016

**Load Monitoring**  
13.12.2016

**copyright**  
Copyright  
13.12.2016

# Power Jacks Portal

Users | Configure CAD | Select Product | Contact Us | Change Region



Search

CALL UK SALES: +44 (0)1358 285100  
VERTRIEB: +49 (0)7522 7892642

- ABOUT US
- PRODUCTS
- DOWNLOADS & VIDEOS
- INDUSTRIES
- NEWS & EVENTS
- WHERE TO BUY
- SUPPORT

Dashboard

## Dashboard

Hello Bruce, you last logged in on 26-02-2018.

Profile

Manage your personal details

Update security settings

User Hub

Engineering

3D CAD configurator and product selector.

- CAD configurator
- Product selector

Engineering Hub

Marketing Hub

Email preferences

Update

Marketing Hub

Help

Get help and support

Support Hub

# Catering for “U2 Access”

“Still haven’t found what I’m looking for?” then use:

- CAD Configurator
  - User knows which product to select.
  - Navigate to product, set variables & download CAD.
  
- Product Selector
  - User needs help
  - Only has application detail
  - Is not familiar with products & how to select
  - Enter application detail into product selector & it recommends product.
  - Link product to related CAD & Data Sheet Content

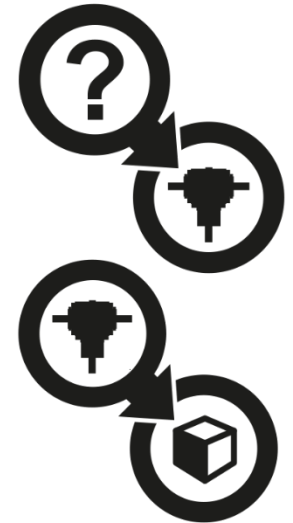

# Portal – CAD Selection

## ○ CAD Configurator



Users | Configure CAD | Select Product | Contact Us | Change Region

Search

CALL UK SALES: +44 (0)1358 285100  
VERTRIEB: +49 (0)7522 7892642

ABOUT US | PRODUCTS | DOWNLOADS & VIDEOS | INDUSTRIES | NEWS & EVENTS | WHERE TO BUY | SUPPORT

Dashboard < Engineering: CAD Configurator

## Engineering: CAD Configurator

Search



POWER JACKS LTD  
POWER JACKS LTD



Screw Jacks

14.12.2016



Bevel Gearboxes

17.01.2017



Linear Actuators

19.12.2016

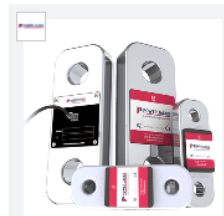

Load Monitoring

13.12.2016



Copyright

13.12.2016

powered by CADENAS | Legal notice | Data privacy policy | Tracking Policy | DE-212

# Portal – CAD Selection

## ○ Graphical Selection

### Engineering: CAD Configurator

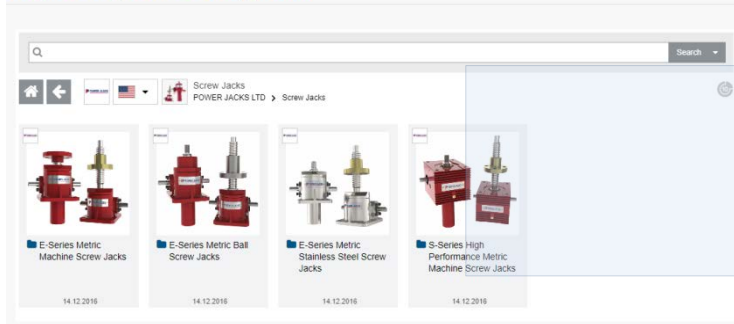

### Engineering: CAD Configurator

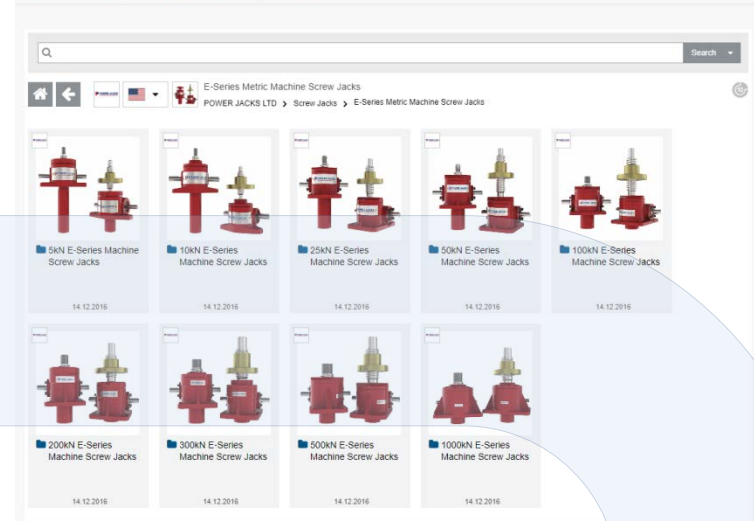

### Engineering: CAD Configurator

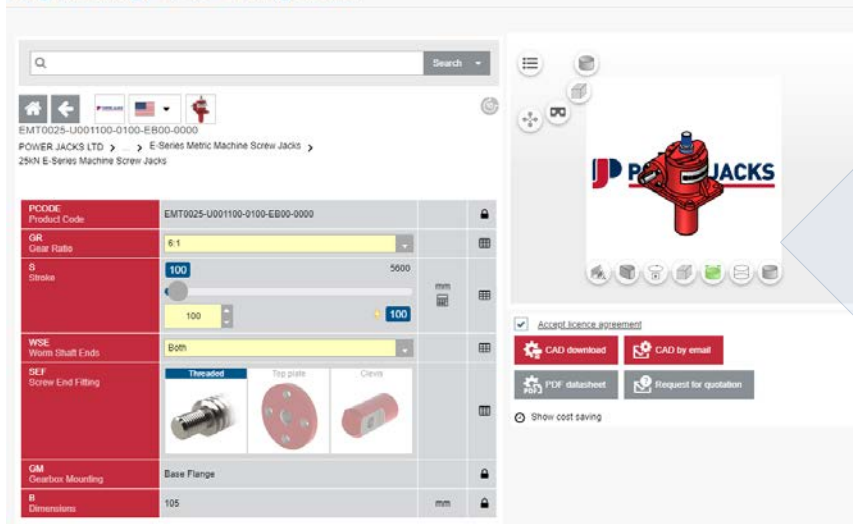

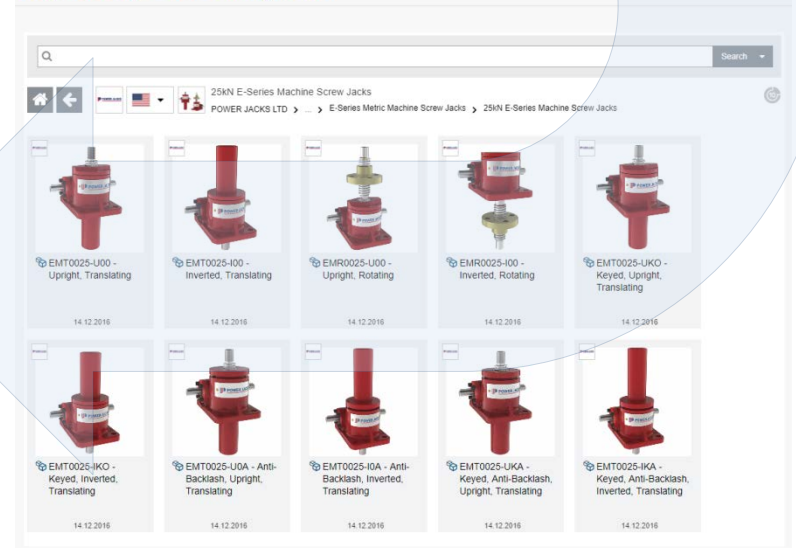

### Engineering: CAD Configurator



# CAD - Selection

## ○ Configure Product

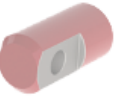
PCODE Product Code	EMT0025-U001100-0100-EB00-0000		🔒
GR Gear Ratio	6:1		📅
S Stroke	100	5600	mm 📅
WSE Worm Shaft Ends	Both		📅
SEF Screw End Fitting	  		📅
GM Gearbox M			🔒
B Dimension			mm 🔒

Dynamic Dimensions

Branded CAD Model

Call to Action

# Portal – Bevel Gearbox Product Selector

- Navigate from Dashboard or from CAD Configurator

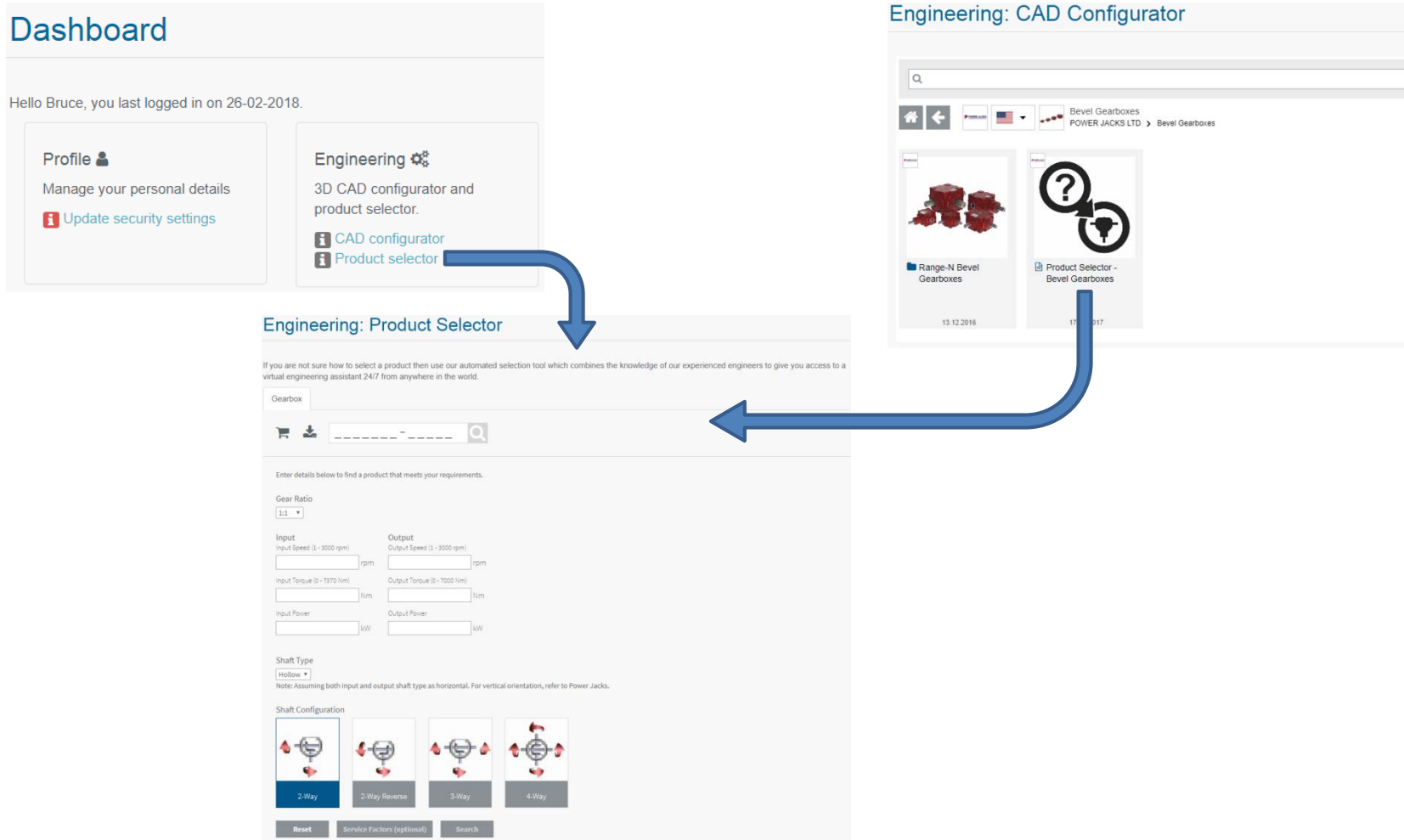



# Portal – Bevel Gearbox Product Selector

- Enter the Application Details

## Basic Details

Enter details below to find a product that meets your requirements.

### Gear Ratio

1:1

### Input

Input Speed (1 - 3000 rpm)

1500 rpm

Input Torque (0 - 7370 Nm)

35.7 Nm

Input Power

5.608 kW

### Output

Output Speed (1 - 3000 rpm)

1500 rpm

Output Torque (0 - 7000 Nm)

35 Nm

Output Power

5.496 kW

### Shaft Type

Solid

Note: Assuming both input and output shaft type as horizontal. For vertical orientation, refer to Power Jacks.

### Shaft Configuration



Reset

Service Factors (optional)

Search

## Extended Details

### Mechanical Service Factor

1.7188

Note: Please input the required Mechanical Service Factor if known, otherwise use the selection criteria below.

### Shock Load Factor

Gear Application

Conveyor Belts

Input Power Source

Electric Motor

Operating Hours

> 10

Shock Load Factor: 1.25

Number of Starts/Hour

up to 60

Transmission Factor

Chains

Duty Cycle (% per Hour)

60

Ambient Temperature (°C)

25

Back

Search

# Portal – Bevel Gearbox Product Selector

## ○ Get The Product Recommendation

Part Number: N370S30-10M05-0000-0000-000000

Product Code

Description: Range-N Bevel Gearbox

Product Summary

Product Code: N37

Shaft Type: Solid Shaft

Configuration: 3-Way Standard Gear Configuration

Gear Ratio: 1:1 Gear Ratio

[Download PDF Fact Sheet](#)

[Download 2D/3D CAD Files](#)

[Add to Shopping Cart](#)

CAD & PDF Download

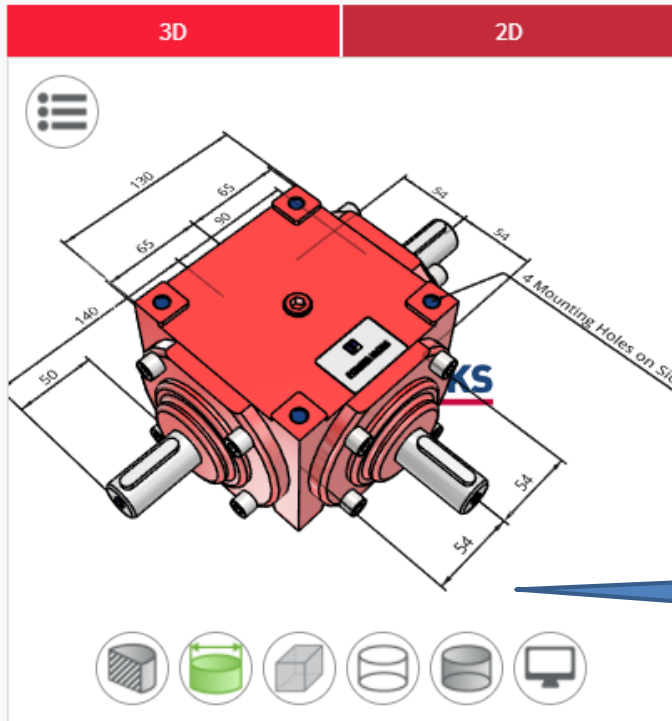

Product Preview

Calculation Results

Rating Table for efficiency 0.98

Input Speed (rpm)	Input Torque (Nm)	Input Power (KW)	Output Speed (rpm)	Output Torque (Nm)	Output Power (KW)	Mechanical Service Factor	Limiting Thermal Power (KW)
875	81.9	7.5	875	80.3	7.35	1.625	12.6225

# Portal – Downloads

- 3D & 2D CAD Models / Drawings
- +
- PDF “Configured” Data Sheets

Standard,  
Configured &  
Interactive 3D Views

**CONFIGURED DATA SHEET**

**POWER JACKS**  
Lifting and Positioning Solutions

**E-Series Ball Screw Jacks**  
Inverted, Translating  
**MODEL: EBT0100-1001100-0100-EU50-CEC2**



Product Image



Configured Product Image



Configured Product - Dynamic 3D Content

Power Jacks Limited  
Balmacrae Commercial Park  
Elop, A64 1 8RX  
Scotland (UK)

[www.powerjacks.com](http://www.powerjacks.com)  
sales@powerjacks.com  
Tel: +44 (0)1358 285100

Page 1 of 3  
Registered in Scotland No. 103848 VAT number: GB 470 9556 17

Configured 2D  
Drawing with  
Dimensions

**CONFIGURED DATA SHEET**

**POWER JACKS**  
Lifting and Positioning Solutions

**E-Series Ball Screw Jacks**  
Inverted, Translating  
**MODEL: EBT0100-1001100-0100-EU50-CEC2**

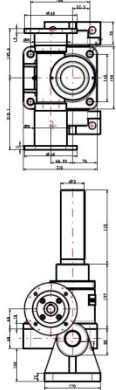

Note: All dimensions in mm unless otherwise stated

Power Jacks Limited  
Balmacrae Commercial Park  
Elop, A64 1 8RX  
Scotland (UK)

[www.powerjacks.com](http://www.powerjacks.com)  
sales@powerjacks.com  
Tel: +44 (0)1358 285100

Page 2 of 3  
Registered in Scotland No. 103848 VAT number: GB 470 9556 17

Configuration  
Selected

**CONFIGURED DATA SHEET**

**POWER JACKS**  
Lifting and Positioning Solutions

**E-Series Ball Screw Jacks**  
Inverted, Translating  
**MODEL: EBT0100-1001100-0100-EU50-CEC2**

**CONFIGURATION SUMMARY**

Product Code	EBT0100-1001100-0100-EU50-CEC2
Option Feature - 1	None
Option Feature - 2	None
Gear Ratio	8:1
Lifting Screw Lead	Option 1 Lead - Right Hand/Standard
Worm Shaft Type	Standard Material
Stroke (mm)	100
Worm Shaft Ends	Both
Screw End Fitting	Threaded
Dynamic Mounting	Throttle Mount, Standard + Throttle Post
Lifting Screw Material	Stainless Steel
Lifting Screw Covers	Cover Pipe and Nut Bellows Boot
Drive Type	Motor Actuator R14 and Coupling - LHS
Motor Frame Size / Drive Interface Size	100
Mounting Kit for Limit Switches & Stop Nuts	RLS-S1 Rotary Cam Limit Switch - TRIS
Paint / Lubricant / Grease	Standard Paint, Number Grade Lubricant and Grease

Note: All rights reserved by Power Jacks Limited. May not be copied in whole or in part.

Power Jacks Limited  
Balmacrae Commercial Park  
Elop, A64 1 8RX  
Scotland (UK)

[www.powerjacks.com](http://www.powerjacks.com)  
sales@powerjacks.com  
Tel: +44 (0)1358 285100

Page 3 of 3  
Registered in Scotland No. 103848 VAT number: GB 470 9556 17

# Current Status

- CAD Configurator
  - C-Series Screw Jacks
  - E-Series Screw Jacks
    - Machine Screw
    - Stainless Steel
    - Ball Screw
  - S-Series Screw Jacks
  - Range-N Bevel Gearboxes
  - EMA Actuators
  - Load Links
- Product Selector
  - Range-N Bevel Gearboxes
- 3D Preview
  - E-Series Screw Jacks



# Next Step

- CAD Configurator
  - Increase Model Options



- Product Selector
  - Screw Jack



- 3D Preview
  - C-Series Screw Jacks
  - Range-N Bevel Gearboxes



# Power Jacks - Lifting & Positioning Solutions

Thank You

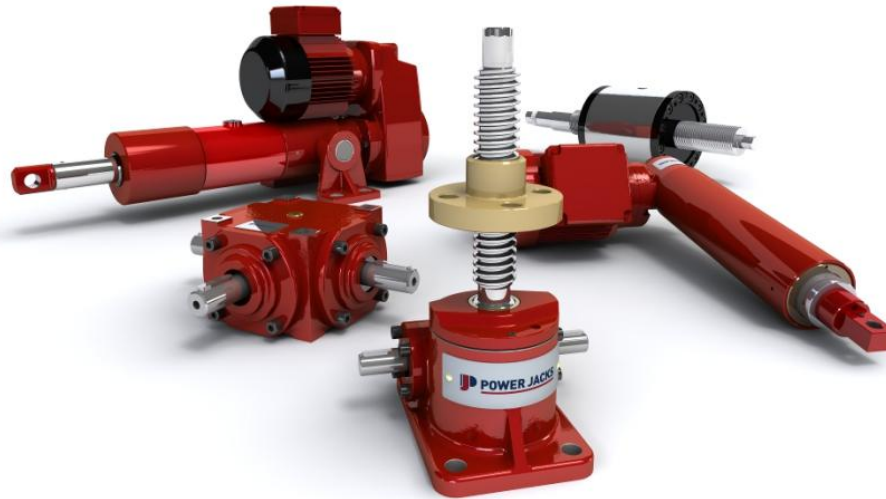

PRECISION SCREW JACKS. JACKING SYSTEMS.  
ELECTRIC LINEAR ACTUATORS. SERIAL BEVEL GEARBOXES.