

TKR series

Extremely quiet and low-vibration
for highly dynamic applications*



* Some features can be different
for certain types for design reasons.

Trademarks are legally protected for the TSUBAKI KABLSCHLEPP GmbH
as a national or international registration in the following countries:
tsubaki-kabelschlepp.com/trademarks

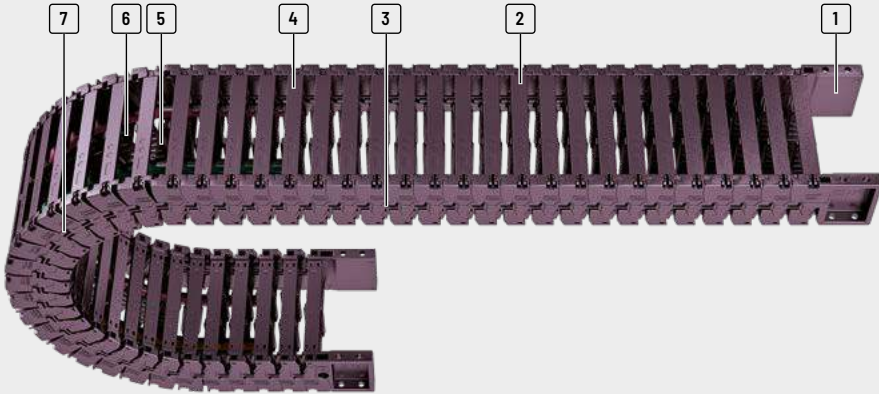

- 1 Variable connection for quick assembly
- 2 Easy and quick to open
- 3 Extremely quiet and low-vibration operation
- 4 Can be opened at any position
- 5 Fixable dividers
- 6 Many separation options for the cables
- 7 Chain link and joint connection with captive connection

Features

- » Long service life
- » Ideal for highly dynamic applications
- » High side stability
- » Cleanroom compatible
- » Modular design allows easy shortening and extending

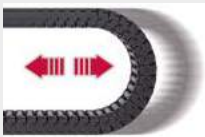
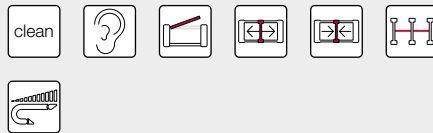

Ideal for highly dynamic applications



UMB end connector to the connection from the face side, from the top or from the bottom



Molded, captive connecting elements

PROTUM®
series

K
series

UNIFLEX
Advanced
series

M
series

TKHD
series

XL
series

QUANTUM®
series

TKR
series

TKA
series

UAT
series

Type	Opening variant	Stay variant	h_i [mm]	h_G [mm]	B_i [mm]	B_k [mm]	B_i - grid [mm]	t [mm]	KR [mm]	Additional load ≤ [kg/m]	Cable- d_{max} [mm]	
PROTUN® series												
K series												
	TKR0150		030	22	275	20-60	34-74	-	15	40-75	2	17,5
UNIFLEX Advanced series												
M series												
	TKR0200		030	28	37	40-120	56-136	-	20	55-150	2,5	22
TKHD series												
	TKR0260		030	40	54	50-200	76-226	-	26	75-150	8	32
XL series												
	TKR0280		030	52	66	50-200	80-230	-	28	75-200	10	41
QUANTUM® series												
TKR series												
	TKR0370		RE	28	35	40-80	59-99	-	37	55-100	2,4	25

* For values > 20 m/s², please contact us, we are happy to advise you.

Cleanroom compatible and long service life

The movable connectors are directly molded on the chain links. In contrast to conventional bore-hole bolt connections, hardly any wear occurs (link abrasion), which makes the TKR type excellent for use in clean rooms.

The special design of the connecting elements additionally increases the service life of the system.

Unsupported arrangement			Gliding arrangement			Inner Distribution				Movement			Page
Travel length ≤ [m]	$V_{max} \leq [m/s]$	$a_{max} \leq [m/s^2]$	Travel length ≤ [m]	$V_{max} \leq [m/s]$	$a_{max} \leq [m/s^2]$	TS0	TS1	TS2	TS3	vertical hanging or standing	lying on the side	rotating arrangement	
										•	-	-	538
1,75	5	200*	-	-	-	•	•	-	-	•	-	-	538
<hr/>													
<hr/>													
2,75	5	200*	-	-	-	•	•	-	-	•	-	-	544
<hr/>													
<hr/>													
3,9	5	200*	-	-	-	•	•	-	•	•	-	-	550
<hr/>													
<hr/>													
4,9	5	200*	-	-	-	•	•	-	•	•	-	-	556
<hr/>													
<hr/>													
2,8	5	200*	-	-	-	•	•	-	-	•	-	-	562
<hr/>													
<hr/>													

PROTUM® series

K series

UNIFLEX Advanced series

M series

TKHD series

XL series

QUANTUM® series

TKR series

TKA series

UAT series

Ideal for highly dynamic applications

The TKR features extremely quiet and low-vibration operation. The so-called polygon effect is reduced to a minimum. Ideal areas of application are in particular in handling and assembly systems, robots, metrology devices,

pick-and-place machines, printing and textile machines. Due to the **very quiet running**, the TKR types are ideal for **low-vibration applications with linear drives**.

TKR0150



Pitch
15 mm



Inner height
22 mm



Inner widths
20 – 60 mm



Bending radii
40 – 75 mm

Stay variants



Design 030..... page 538

Frame with outside detachable crossbar

- Low-vibration plastic frame with particularly long service life thanks to molded chain links.
- **Outside:** Swivable and detachable.



TOTALTRAX® complete systems

Benefit from the advantages of the TOTALTRAX® complete system. A complete delivery from one source – with a warranty certificate on request! Learn more at tsubaki-kabelschlepp.com/totaltrax



TRAXLINE® cables for cable carriers

Hi-flex electric cables which were especially developed, optimized and tested for use in cable carriers can be found at tsubaki-kabelschlepp.com/traxline

Unsupported arrangement

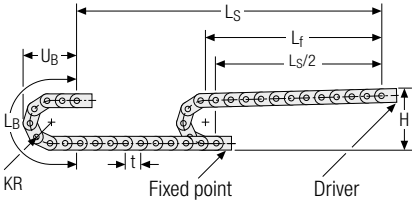

KR [mm]	H [mm]	L _B [mm]	U _B [mm]
40	120	156	70
50	140	187	80
75	190	266	105

Load diagram for unsupported length depending on the additional load.

Sagging of the cable carrier is technically permitted for extended travel lengths, depending on the specific application.

Intrinsic cable carrier weight $q_k = 0.3 \text{ kg/m}$ at B_i 20 mm. For other inner widths, the maximum additional load changes.

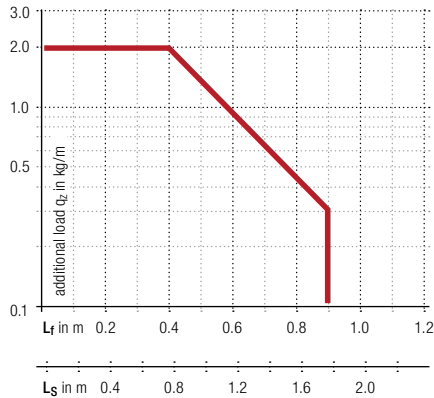

Speed
up to 5 m/s

Acceleration
up to 200 m/s²*

Travel length
up to 1.75 m

Additional load
up to 2.0 kg/m

* For values > 20 m/s², please contact us, we are happy to advise you!

PROTUM® series
K series
UNIFLEX Advanced series
M series
TKHD series
XL series
QUANTUM® series
TKR series
TKA series
UAT series

More product information online



Assembly instructions etc.:
Additional info via your smartphone or check online at tsubaki-kabelschlepp.com/downloads



Configure your custom cable carrier here:
online-engineer.de

Stay variant 030 – with outside opening and detachable crossbars

- Low-vibration plastic frame with particularly long service life thanks to molded chain links.
- Swivable and detachable on one side in any position.
- **Outside:** Swivable and detachable.



Stay arrangement on each chain link (**VS: fully-stayed**)



B_i 20 – 60 mm

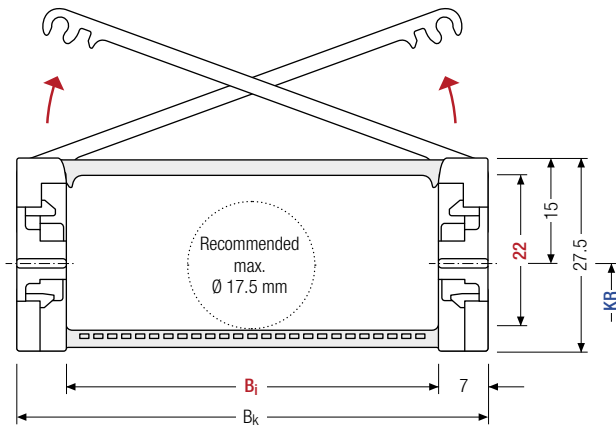

The maximum cable diameter strongly depends on the bending radius and the desired cable type. Please contact us.

Calculating the cable carrier length

Cable carrier length L_k

$$L_k \approx \frac{L_S}{2} + L_B$$

Cable carrier length L_k rounded to pitch t for even number of chain links

h_i [mm]	h_G [mm]	B_i [mm]	B_k [mm]	KR [mm]	q_k [kg/m]
22	27.5	20	40	50	0.3 – 0.5
		60	$B_i + 14$	75	

Order example



TKR0150

Type

60

B_i [mm]

030

Stay variant

75

KR [mm]

800

L_k [mm]

VS

Stay arrangement

Divider systems

As standard, the divider system is mounted on every 2nd chain link

The dividers are easily attached to the stay for applications with transverse accelerations and for applications laying on the side by simply turning them.

As a standard, dividers and the complete divider system (dividers with height separations) can be moved in the cross section (**version A**).

The arresting cams click into place in the locking grids in the crossbars (**version B**).

Divider system TSO without height separation

Vers.	a _T min [mm]	a _x min [mm]	a _c min [mm]	a _x grid [mm]	n _T min
A	5	6	4	—	—
B	6	6	4	2	—

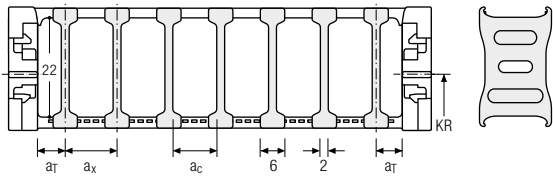

Divider system TS1 with continuous height separation

Vers.	a _T min [mm]	a _x min [mm]	a _c min [mm]	a _x grid [mm]	n _T min
A	5	6	4	—	2
B	6	6	4	2	2

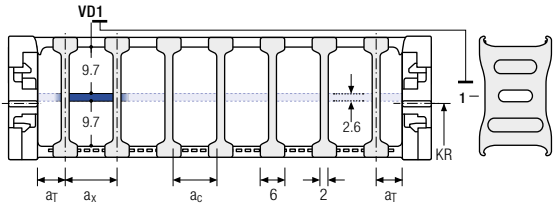

Order example

TS1

A

3

VD0

⋮

VD1

Divider system
Version
n_T
Height separation

Please state the designation of the divider system (**TS0, TS1 ...**), version and number of dividers per cross section [n_T].

If using divider systems with height separation (**TS1**) please also state the positions [e.g. VD1] viewed from the left driver belt. You are welcome to add a sketch to your order.

PROTUM® series
K series
UNIFLEX Advanced series
M series
TKHD series
XL series
QUANTUM® series
TKR series
TKA series
UAT series

One-part end connectors – plastic

The plastic end connectors can be **connected from above or from below**. The connection type can be changed by changing the orientation of the end connector.

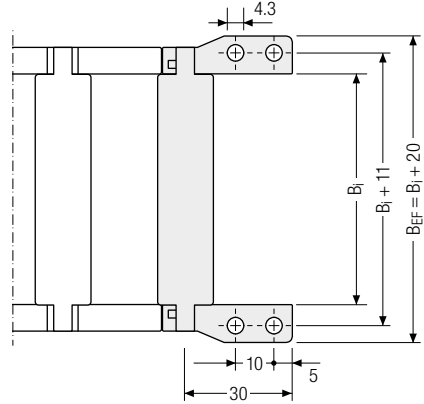
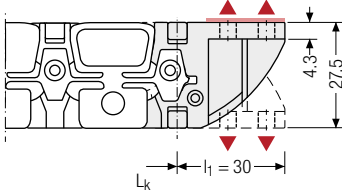

▲ Assembly options



Recommended tightening torque:
0,6 Nm for screws M4

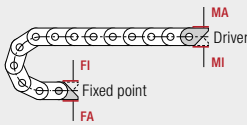

Connection point

F – fixed point
M – driver

Connection type

A – threaded joint outside (standard)
I – threaded joint inside

Order example



Plastic	F	A
Plastic	M	A
End connector	Connection point	Connection type



We recommend the use of strain reliefs at the driver and fixed point. See from p. 902.

More product information online



Assembly instructions etc.:
Additional info via your smartphone or check online at tsubaki-kabelschlepp.com/downloads



Configure your custom cable carrier here:
online-engineer.de



Subject to change without notice.

UAT series	TKA series	TKR series	QUANTUM® series	XL series	TKHD series	M series	UNIFLEX Advanced series	K series	PROTUM® series
------------	------------	-------------------	-----------------	-----------	-------------	----------	-------------------------	----------	----------------

TKR0200

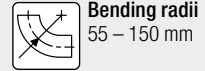
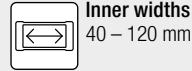

Stay variants

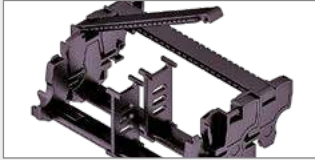

Design 030..... page 544

Frame with outside detachable crossbar

- Low-vibration plastic frame with particularly long service life thanks to molded chain links.
- **Outside:** Swivable and detachable
- **Inside:** detachable



TOTALTRAX® complete systems

Benefit from the advantages of the TOTALTRAX® complete system. A complete delivery from one source – with a warranty certificate on request! Learn more at tsubaki-kabelschlepp.com/totaltrax

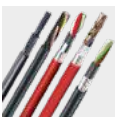

TRAXLINE® cables for cable carriers

Hi-flex electric cables which were especially developed, optimized and tested for use in cable carriers can be found at tsubaki-kabelschlepp.com/traxline

Unsupported arrangement

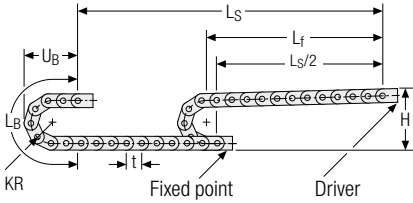

KR [mm]	H [mm]	L _B [mm]	U _B [mm]
55	182	253	116
75	222	316	136
95	262	379	156
150	372	552	211

Load diagram for unsupported length depending on the additional load.

Sagging of the cable carrier is technically permitted for extended travel lengths, depending on the specific application.

Intrinsic cable carrier weight $q_k = 0.6 \text{ kg/m}$ at $B_i 40 \text{ mm}$. For other inner widths, the maximum additional load changes.

Speed
up to 5 m/s

Acceleration
up to 200 m/s²*

Travel length
up to 2.75 m

Additional load
up to 2.5 kg/m

* For values > 20 m/s², please contact us, we are happy to advise you!

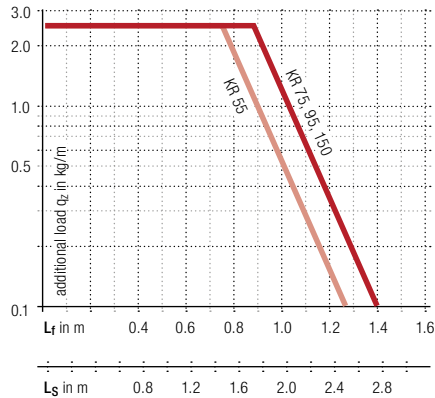

PROTUM® series
K series
UNIFLEX Advanced series
M series
TKHD series
XL series
QUANTUM® series
TKR series
TKA series
UAT series

More product information online



Assembly instructions etc.:
Additional info via your
smartphone or check online at
[tsubaki-kabelschlepp.com/
downloads](http://tsubaki-kabelschlepp.com/downloads)



Configure your custom
cable carrier here:
online-engineer.de

Stay variant 030 – with outside opening and detachable crossbars

- Low-vibration plastic frame with particularly long service life thanks to molded chain links.
- Swivable and detachable on one side in any position.
- **Outside:** Swivable and detachable
- **Inside:** detachable



Stay arrangement on each chain link (**VS: fully-stayed**)



B_i 40 – 120 mm

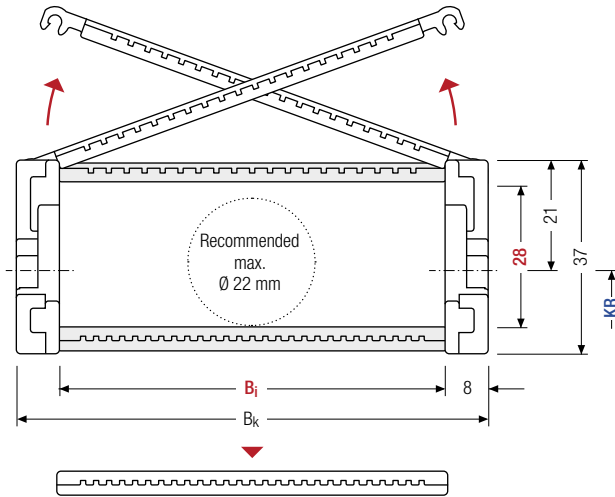

The maximum cable diameter strongly depends on the bending radius and the desired cable type. Please contact us.

Calculating the cable carrier length

Cable carrier length L_k

$$L_k \approx \frac{L_S}{2} + L_B$$

Cable carrier length L_k rounded to pitch t for odd number of chain links

h_i [mm]	h_G [mm]	B_i [mm]						B_k [mm]	KR [mm]				q_k [kg/m]
28	37	40	50	60	80	100	120	$B_i + 16$	55	75	95	150	0.6 – 1.0

Order example



TKR0200

Type

80

B_i [mm]

030

Stay variant

95

KR [mm]

800

L_k [mm]

VS

Stay arrangement

Divider systems

As standard, the divider system is mounted on every 2nd chain link.

Fixable dividers are available for applications with lateral accelerations and for applications lying on the side.

As a standard, dividers and the complete divider system (dividers with height separations) can be moved in the cross section (**version A**).

The arresting cams click into place in the locking grids in the crossbars (**version B**).

Divider system TSO without height separation

Vers.	a _T min [mm]	a _x min [mm]	a _c min [mm]	a _x grid [mm]	n _T min
A	4	8	6	—	—
B	4	8	6	4	—

B _i [mm]	40	50	60	80	100	120
a _T min [mm]	4	5	6	4	6	6

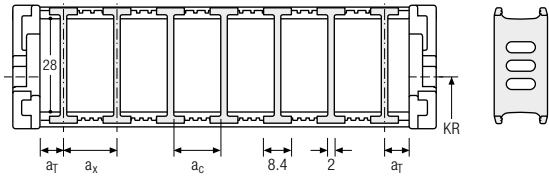

Divider system TS1 with continuous height separation

Vers.	a _T min [mm]	a _x min [mm]	a _c min [mm]	a _x grid [mm]	n _T min
A	4	8	6	—	2
B	4	8	6	4	2

B _i [mm]	40	50	60	80	100	120
a _T min [mm]	4	5	6	4	6	6

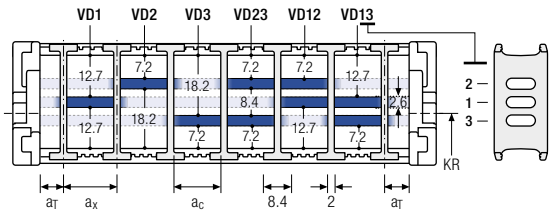

Order example

TS1 · A · 3 - VD0
VD1
 Divider system Version n_T Height separation

Please state the designation of the divider system (**TS0, TS1 ...**), version and number of dividers per cross section [n_T].

If using divider systems with height separation (**TS1**) please also state the positions [e.g. VD1] viewed from the left driver belt. You are welcome to add a sketch to your order.

PROTUM® series
K series
UNIFLEX Advanced series
M series
TKHD series
XL series
QUANTUM® series
TKR series
TKA series
UAT series

UMB end connectors UMB – plastic

The universal mounting brackets (UMB) are made from plastic and can be mounted from the top, from the bottom or face on.

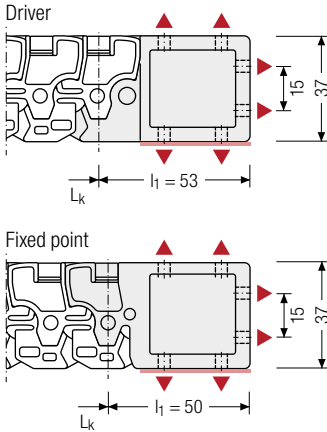

▲ Assembly options

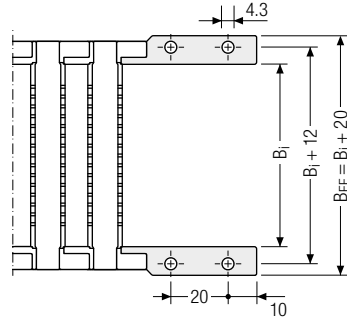

 Recommended tightening torque:
0,6 Nm for screws M4

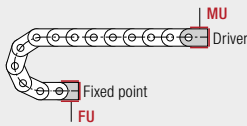

Connection point

F – fixed point
M – driver

Connection type

U – universal mounting bracket

Order example

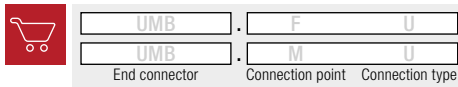

 We recommend the use of strain reliefs at the driver and fixed point. See from p. 902.

More product information online



Assembly instructions etc.:
Additional info via your smartphone or check online at tsubaki-kabelschlepp.com/downloads



Configure your custom cable carrier here:
online-engineer.de



Subject to change without notice.

PROTUM®
series

K
series

UNIFLEX
Advanced
series

M
series

TKHD
series

XL
series

QUANTUM®
series

**TKR
series**

TKA
series

UAT
series

TKR0260



Pitch
26 mm



Inner height
40 mm



Inner widths
50 – 200 mm



Bend radii
75 – 150 mm

Stay variants

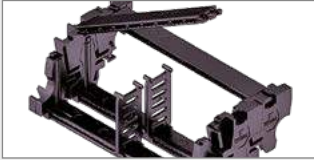

Design 030..... page 550

Frame with outside detachable crossbar

- Low-vibration plastic frame with particularly long service life thanks to molded chain links.
- **Outside:** Swivable and detachable
- **Inside:** detachable



TOTALTRAX® complete systems

Benefit from the advantages of the TOTALTRAX® complete system. A complete delivery from one source – with a warranty certificate on request! Learn more at tsbaki-kabelschlepp.com/totaltrax

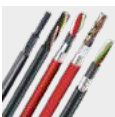

TRAXLINE® cables for cable carriers

Hi-flex electric cables which were especially developed, optimized and tested for use in cable carriers can be found at tsbaki-kabelschlepp.com/traxline

Unsupported arrangement

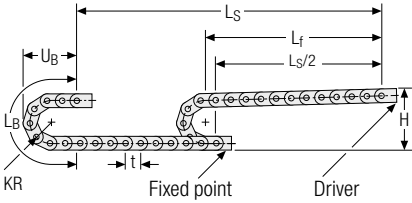

KR [mm]	H [mm]	L _B [mm]	U _B [mm]
75	238	340	156
100	288	418	181
125	338	497	206
150	388	575	231

Load diagram for unsupported length depending on the additional load.

Sagging of the cable carrier is technically permitted for extended travel lengths, depending on the specific application.

Intrinsic cable carrier weight $q_k = 1.5 \text{ kg/m}$ at B; 50 mm. For other inner widths, the maximum additional load changes.

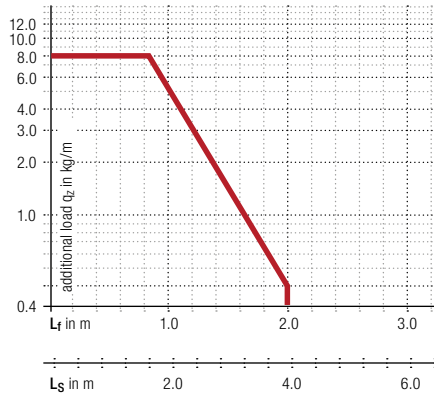

Speed
up to 5 m/s

Acceleration
up to 200 m/s²*

Travel length
up to 3.9 m

Additional load
up to 8.0 kg/m

* For values > 20 m/s², please contact us, we are happy to advise you!

PROTUM® series

K series

UNIFLEX Advanced series

M series

TKHD series

XL series

QUANTUM® series

TKR series

TKA series

UAT series

More product information online



Assembly instructions etc.:
Additional info via your smartphone
or check online at
[tsubaki-kabelschlepp.com/
downloads](http://tsubaki-kabelschlepp.com/downloads)



Configure your custom cable carrier
here:
online-engineer.de

Stay variant 030 – with outside opening and detachable crossbars

- Low-vibration plastic frame with particularly long service life thanks to molded chain links.
- Swivable and detachable on one side in any position.
- **Outside:** Swivable and detachable
- **Inside:** detachable



Stay arrangement on each chain link (**VS: fully-stayed**)



B_i 50 – 200 mm

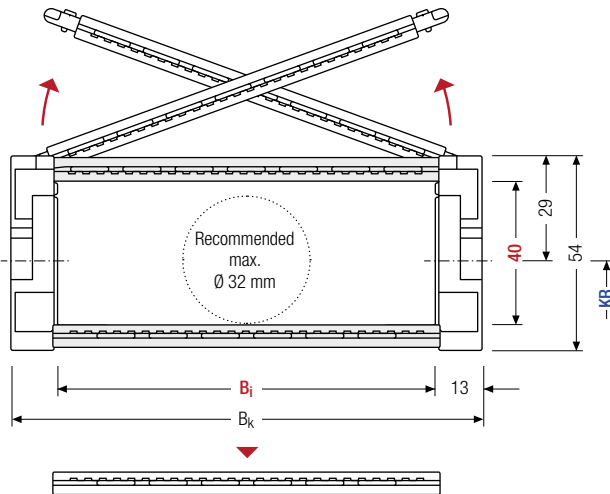

The maximum cable diameter strongly depends on the bending radius and the desired cable type. Please contact us.

Calculating the cable carrier length

Cable carrier length L_k

$$L_k \approx \frac{L_S}{2} + L_B$$

Cable carrier length L_k rounded to pitch t for odd number of chain links

h_i [mm]	h_G [mm]	B_i [mm]								B_k [mm]	KR [mm]				q_k [kg/m]
40	54	50	62	75	87	100	125	150	200	$B_i + 26$	75	100	125	150	1.5 – 2.7

Order example



TKR0260

Type

100

B_i [mm]

030

Stay variant

125

KR [mm]

800

L_k [mm]

VS

Stay arrangement

Divider systems

As standard, the divider system is mounted on every 2nd chain link.

Fixable dividers are available for applications with lateral accelerations and for applications lying on the side.

As a standard, dividers and the complete divider system (dividers with height separations) can be moved in the cross section (**version A**).

The arresting cams click into place in the locking grids in the crossbars (**version B**).

Divider system TS0 without height separation

Vers.	a _T min [mm]	a _X min [mm]	a _C min [mm]	a _X grid [mm]	π _T min
A	3	8	5.6	—	—
B	•	8	5.6	4	—

B _i [mm]	50	62	75	87	100	125	150	200
a _T min [mm]	5	7	5.5	3.5	6	6.5	7	4

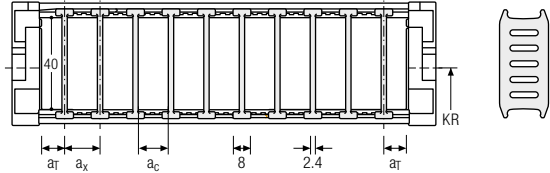

Divider system TS1 with continuous height separation

Vers.	a _T min [mm]	a _X min [mm]	a _C min [mm]	a _X grid [mm]	π _T min
A	3	8	5.6	—	2
B	•	8	5.6	4	2

B _i [mm]	50	62	75	87	100	125	150	200
a _T min [mm]	5	7	5.5	3.5	6	6.5	7	4

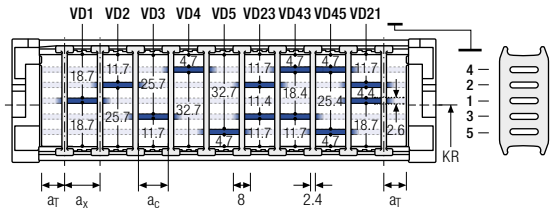

Divider system TS3 with height separation made of aluminum partitions

Vers.	a _T min [mm]	a _X min [mm]	a _C min [mm]	a _X grid [mm]	π _T min
A	3	26	20	—	2
B	•	28	22	4	2

B _i [mm]	50	62	75	87	100	125	150	200
a _T min [mm]	5	7	5.5	3.5	6	6.5	7	4

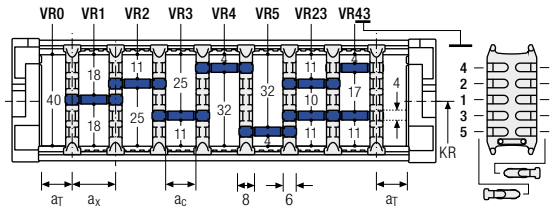

The dividers are fixed by the partitions, the complete divider system is movable in the cross section.

 Aluminum section subdivisions are only available with a_X > 26 mm.

PROTUM® series

K series

UNIFLEX Advanced series

M series

TKHD series

XL series

QUANTUM® series

TKR series

TKA series

UAT series

UMB end connectors UMB – plastic

The universal mounting brackets (UMB) are made from plastic and can be mounted from the top, from the bottom or face on.

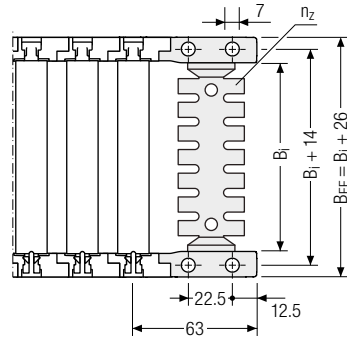
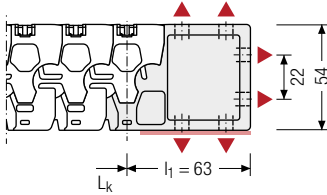

▲ Assembly options

B_1 [mm]	B_{EF} [mm]	n_z
50	76	2 x 3
62	88	–
75	101	2 x 5
87	113	–
100	126	2 x 7
125	151	2 x 9
150	176	2 x 11
200	226	–



Recommended tightening torque:
0.6 Nm for screws M4

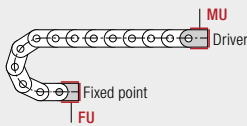

Connection point

F – fixed point
M – driver

Connection type

U – universal mounting bracket

Order example



UMB	•	F	U
UMB	•	M	U
End connector		Connection point	Connection type



We recommend the use of strain reliefs at the driver and fixed point. See from p. 902.



Subject to change without notice.

UAT series	TKA series	TKR series	QUANTUM® series	XL series	TKHD series	M series	UNIFLEX Advanced series	K series	PROTUM® series
------------	------------	-------------------	-----------------	-----------	-------------	----------	-------------------------	----------	----------------

TKR0280



Pitch
28 mm



Inner height
52 mm



Inner widths
50 – 200 mm



Bending radii
75 – 200 mm

Stay variants

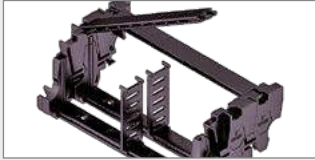

Design 030..... page 556

Frame with outside detachable crossbar

- Low-vibration plastic frame with particularly long service life thanks to molded chain links.
- **Outside:** Swivable and detachable
- **Inside:** detachable



TOTALTRAX® complete systems

Benefit from the advantages of the TOTALTRAX® complete system. A complete delivery from one source – with a warranty certificate on request! Learn more at tsubaki-kabelschlepp.com/totaltrax



TRAXLINE® cables for cable carriers

Hi-flex electric cables which were especially developed, optimized and tested for use in cable carriers can be found at tsubaki-kabelschlepp.com/traxline

Unsupported arrangement

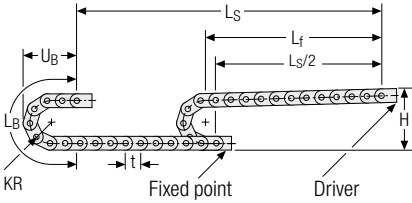

KR [mm]	H [mm]	LB [mm]	UB [mm]
75	252	348	167
100	302	427	192
150	402	584	242
200	502	741	292

Load diagram for unsupported length depending on the additional load.

Sagging of the cable carrier is technically permitted for extended travel lengths, depending on the specific application.

Intrinsic cable carrier weight $q_k = 2.0 \text{ kg/m}$ at $B_i 50 \text{ mm}$. For other inner widths, the maximum additional load changes.

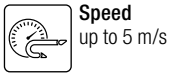
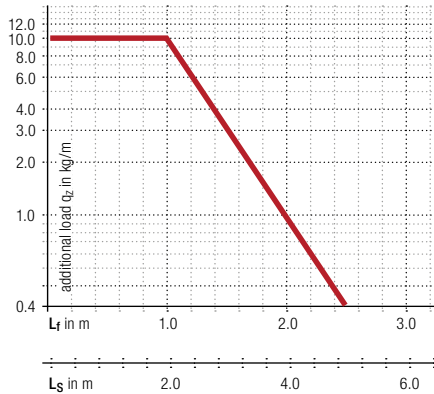

* For values > 20 m/s², please contact us, we are happy to advise you!

PROTUM® series

K series

UNIFLEX Advanced series

M series

TKHD series

XL series

QUANTUM® series

TKR series

TKA series

UAT series

More product information online



Assembly instructions etc.: Additional info via your smartphone or check online at tsubaki-kabelschlepp.com/downloads



Configure your custom cable carrier here: online-engineer.de

Stay variant 030 – with outside opening and detachable crossbars

- Low-vibration plastic frame with particularly long service life thanks to molded chain links.
- Swivable and detachable on one side in any position.
- **Outside:** Swivable and detachable
- **Inside:** detachable



Stay arrangement on each chain link (**VS: fully-stayed**)



B_i 50 – 200 mm

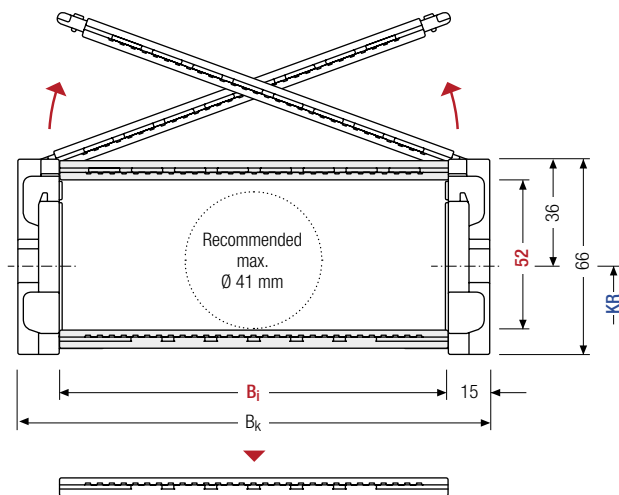

The maximum cable diameter strongly depends on the bending radius and the desired cable type. Please contact us.

Calculating the cable carrier length

Cable carrier length L_k

$$L_k \approx \frac{L_S}{2} + L_B$$

Cable carrier length L_k rounded to pitch t for odd number of chain links

h_i [mm]	h_G [mm]	B_i [mm]								B_k [mm]	KR [mm]				q_k [kg/m]
52	66	50	62	75	87	100	125	150	200	$B_i + 30$	75	100	150	200	2.0 – 3.2

Order example



TKR0280

Type

100

B_i [mm]

030

Stay variant

150

KR [mm]

840

L_k [mm]

VS

Stay arrangement

Divider systems

As standard, the divider system is mounted on every 2nd chain link.

Fixable dividers are available for applications with lateral accelerations and for applications lying on the side.

As a standard, dividers and the complete divider system (dividers with height separations) can be moved in the cross section (**version A**).

The arresting cams click into place in the locking grids in the crossbars (**version B**).

Divider system TS0 without height separation

Vers.	a _T min [mm]	a _X min [mm]	a _C min [mm]	a _X grid [mm]	π _T min
A	3	8	5.6	—	—
B	⬇	8	5.6	4	—

B _i [mm]	50	62	75	87	100	125	150	200
a _T min [mm]	5	7	5.5	3.5	6	6.5	7	4

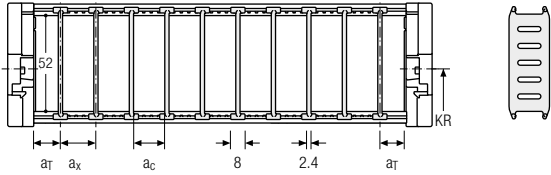

Divider system TS1 with continuous height separation

Vers.	a _T min [mm]	a _X min [mm]	a _C min [mm]	a _X grid [mm]	π _T min
A	3	8	5.6	—	2
B	⬇	8	5.6	4	2

B _i [mm]	50	62	75	87	100	125	150	200
a _T min [mm]	5	7	5.5	3.5	6	6.5	7	4

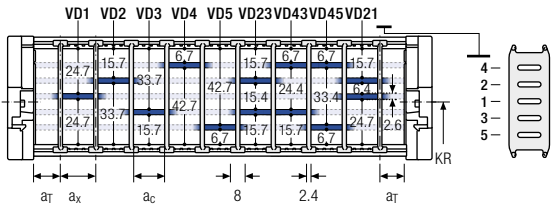

Divider system TS3 with height separation made of aluminum partitions

Vers.	a _T min [mm]	a _X min [mm]	a _C min [mm]	a _X grid [mm]	π _T min
A	3	26	20	—	2
B	⬇	28	22	4	2

B _i [mm]	50	62	75	87	100	125	150	200
a _T min [mm]	5	7	5.5	3.5	6	6.5	7	4

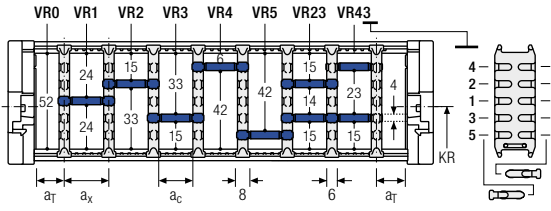

The dividers are fixed by the partitions, the complete divider system is movable in the cross section.

 Aluminum section subdivisions are only available with a_X > 26 mm.

PROTUM® series
K series
UNIFLEX Advanced series
M series
TKHD series
XL series
QUANTUM® series
TKR series
TKA series
UAT series

UMB end connectors UMB – plastic

The universal mounting brackets (UMB) are made from plastic and can be mounted from the top, from the bottom or face on.

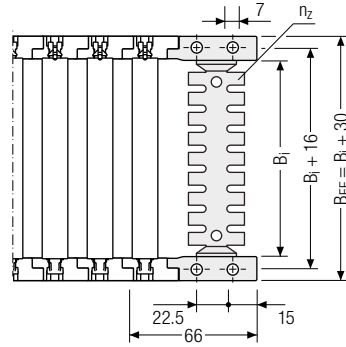
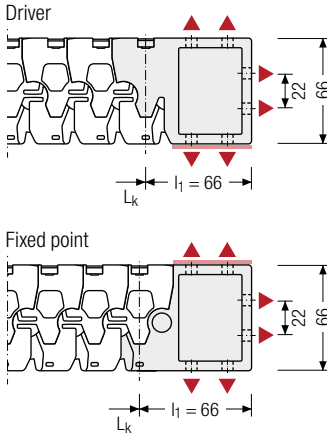

▲ Assembly options

B_i [mm]	B_{EF} [mm]	n_z
50	80	2 x 3
62	92	–
75	105	2 x 5
87	117	–
100	130	2 x 7
125	155	2 x 9
150	180	2 x 11
200	230	–

 Recommended tightening torque:
0.6 Nm for screws M4

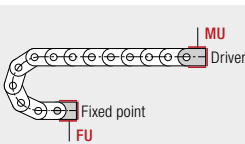

Connection point

F – fixed point
M – driver

Connection type

U – universal mounting bracket

Order example

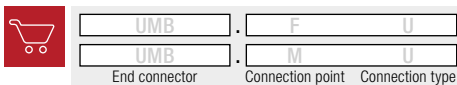

 We recommend the use of strain reliefs at the driver and fixed point. See from p. 902.

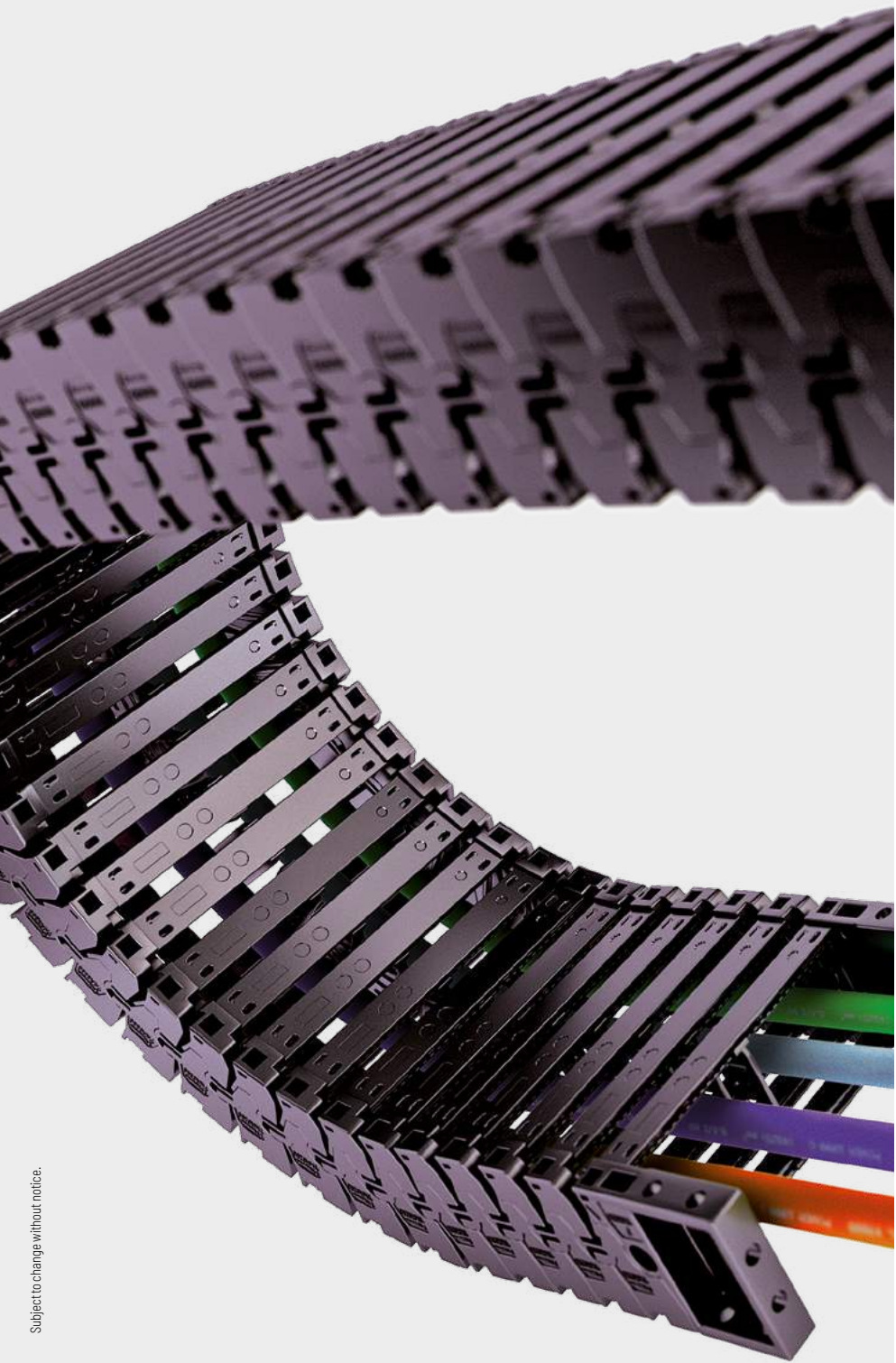

PROTUM®
series

K
series

UNIFLEX
Advanced
series

M
series

TKHD
series

XL
series

QUANTUM®
series

**TKR
series**

TKA
series

UAT
series

TKR0370

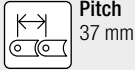

Pitch
37 mm

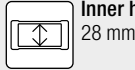

Inner height
28 mm



Inner widths
40 – 80 mm



Bending radii
55 – 100 mm

Stay variants



Plastic stay RE page 562

Frame screw-in stay

- Plastic stay for light to medium loads. Assembly without screws.
- **Outside/inside:** to open by rotating.



TOTALTRAX® complete systems

Benefit from the advantages of the TOTALTRAX® complete system. A complete delivery from one source – with a warranty certificate on request! Learn more at tsubaki-kabelschlepp.com/totaltrax



TRAXLINE® cables for cable carriers

Hi-flex electric cables which were especially developed, optimized and tested for use in cable carriers can be found at tsubaki-kabelschlepp.com/traxline

Unsupported arrangement

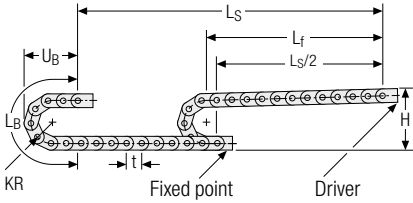

KR [mm]	H [mm]	L _B [mm]	U _B [mm]
75	252	348	167
100	302	427	192
150	402	548	242
200	502	741	292

Load diagram for unsupported length depending on the additional load.

Sagging of the cable carrier is technically permitted for extended travel lengths, depending on the specific application.

Intrinsic cable carrier weight $q_k = 0.55 \text{ kg/m}$ at B_i 50 mm. For other inner widths, the maximum additional load changes.

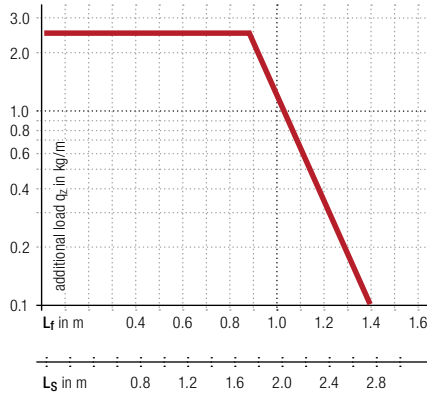

Speed
up to 5 m/s

Acceleration
up to 200 m/s²*

Travel length
up to 2.8 m

Additional load
up to 2.4 kg/m

* For values > 20 m/s², please contact us, we are happy to advise you!

- PROTUM® series
- K series
- UNIFLEX Advanced series
- M series
- TKHD series
- XL series
- QUANTUM® series
- TKR series
- TKA series
- UAT series

More product information online



Assembly instructions etc.:
Additional info via your
smartphone or check online at
[tsubaki-kabelschlepp.com/
downloads](http://tsubaki-kabelschlepp.com/downloads)



Configure your custom
cable carrier here:
online-engineer.de

Plastic stay RE – screw-in frame stay

- Plastic stay for light and medium loads.
Assembly without screws.
- Available in 5 widths.
- **Outside/inside:** to open by rotating.

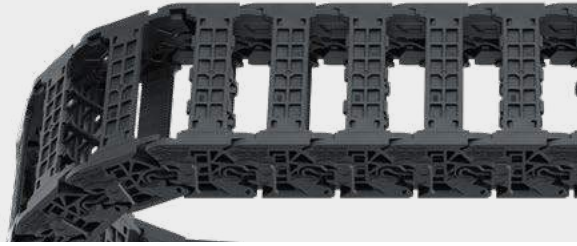

Stay arrangement on each chain link (**VS: fully-stayed**)



B_i 40 – 80 mm

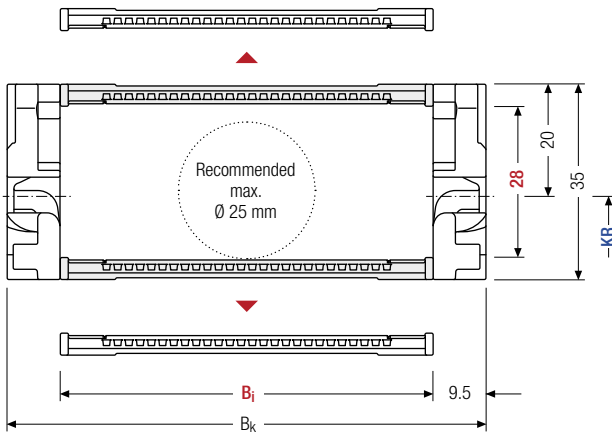

The maximum cable diameter strongly depends on the bending radius and the desired cable type. Please contact us.

Calculating the cable carrier length

Cable carrier length L_k

$$L_k \approx \frac{L_S}{2} + L_B$$

Cable carrier length L_k rounded to pitch t for odd number of chain links

h_i [mm]	h_G [mm]	B_i [mm]					B_k [mm]	KR [mm]			q_k [kg/m]
28	35	40	50	60	70	80	$B_i + 19$	55	75	100	0.53 – 0.61

Order example



TKR0370

Type

80

B_i [mm]

RE

Stay variant

75

KR [mm]

703

L_k [mm]

VS

Stay arrangement

Divider systems

As standard, the divider system is mounted on every 2nd chain link.

Fixable dividers are available for applications with lateral accelerations and for applications lying on the side.

As a standard, dividers and the complete divider system (dividers with height separations) can be moved in the cross section (**version A**).

The arresting cams click into place in the locking grids in the crossbars (**version B**).

Divider system TSO without height separation

Vers.	a _T min [mm]	a _x min [mm]	a _c min [mm]	a _x Raster [mm]	n _T min
A	7.5	8	6	-	-
B	7.5	8	6	2	-

B _i [mm]	40	50	60	70	80
a _T min [mm]	8	9	8	9	8

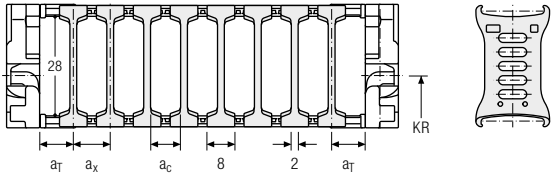

Divider system TS1 with continuous height separation

Vers.	a _T min [mm]	a _x min [mm]	a _c min [mm]	a _x Raster [mm]	n _T min
A	7.5	8	6	-	2
B	7.5	8	6	2	2

B _i [mm]	40	50	60	70	80
a _T min [mm]	8	9	8	9	8

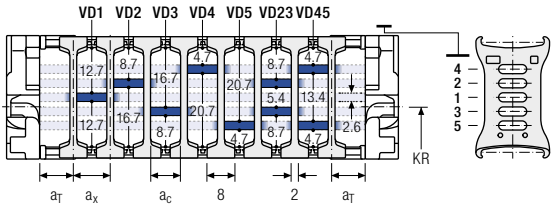

Order example

TS1 · A · 3 - VD0
VD1

Divider system
Version
n_T
Height separation

Please state the designation of the divider system (**TS0, TS1 ...**), version and number of dividers per cross section [n_T].

If using divider systems with height separation (**TS1**) please also state the positions [e.g. VD1] viewed from the left driver belt. You are welcome to add a sketch to your order.

PROTUM® series
K series
UNIFLEX Advanced series
M series
TKHD series
XL series
QUANTUM® series
TKR series
TKA series
UAT series

UMB end connectors UMB – plastic

The universal mounting brackets (UMB) are made from plastic and can be mounted from the top, from the bottom or face on.

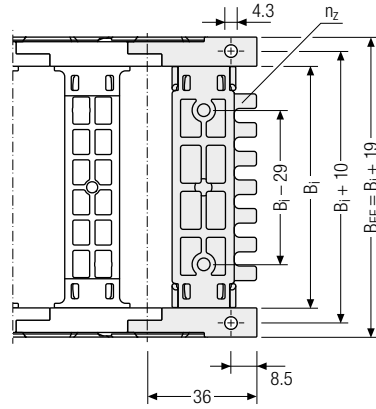
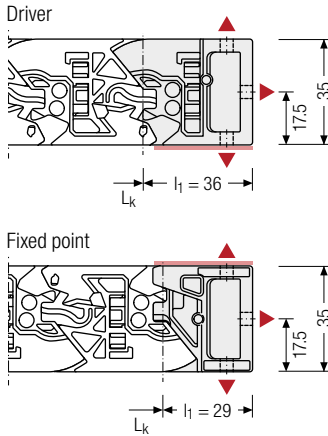

▲ Assembly options

B_i [mm]	B_{EF} [mm]	n_z
40	59	3
50	69	4
60	79	5
70	89	6
80	99	7



Recommended tightening torque:
0.6 Nm for screws M4

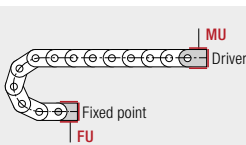

Connection point

F – fixed point
M – driver

Connection type

U – universal mounting bracket

Order example



UMB	F	U
UMB	M	U
End connector	Connection point	Connection type

PROTUM®
seriesK
seriesUNIFLEX
Advanced
seriesM
seriesTKHD
seriesXL
seriesQUANTUM®
series**TKR**
seriesTKA
seriesUAT
series