

TESTINA PRENSILE

PICK-UP HEAD

TETE DE PREHENSION

GREIFERKOPF

TULIPA

cod. 001.0045 ø 75

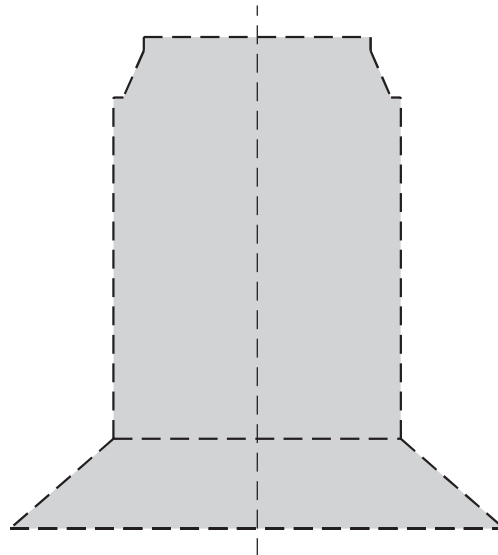
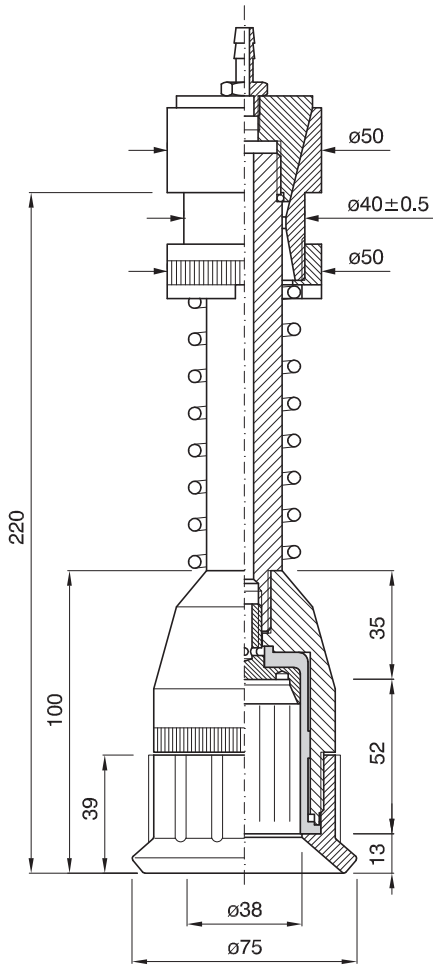

PROFILO INTERNO SCALA 1:1
INTERNAL SECTION SCALE 1:1
PROFIL INTERNE ECHELLE 1:1
INNENPROFIL MASSTAB 1:1
PERFIL INTERIOR ESCALA 1:1

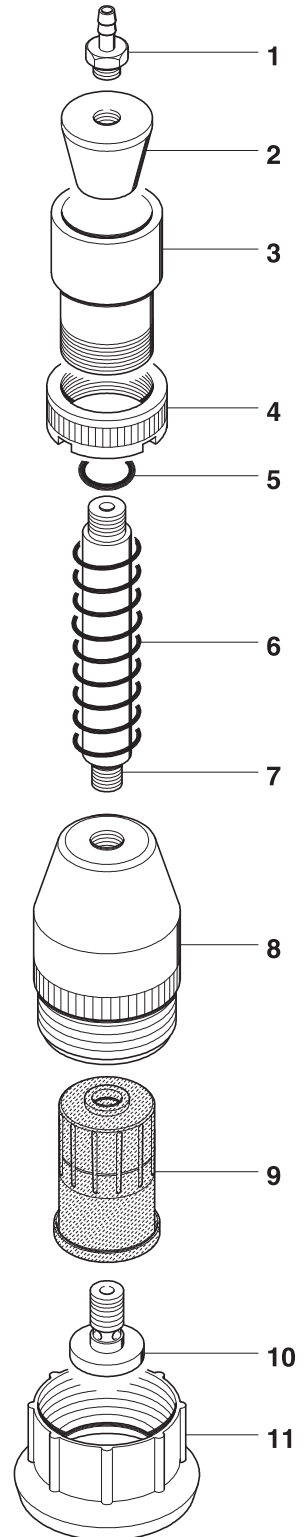

	COD.	MATERIALE	MATERIAL	MATERIEL	WERKSTOFF	MATERIAL
1	024.0001	OTTONE	BRASS	LAITON	MESSING	LATÓN
2	025.0003	PA	PA	PA	PA	PA
3	026.0003	PA	PA	PA	PA	PA
4	026.0013	PA	PA	PA	PA	PA
5	057.0037	GOMMA	RUBBER	CAOUTCHOUC	GUMMI	GOMA
6	029.0009	AISI	STAINLESS STEEL	ACIER INOXYDABLE	ROSTFREIER STAHL	ACERO INOXIDABLE
7	028.0011	AL	AL	AL	AL	AL
8	027.0036	PA	PA	PA	PA	PA
9	040.0023	GOMMA / TPU	RUBBER / TPU	CAOUTCHOUC TPU	GUMMI / TPU	GOMA / TPU
10	030.0011	AL	AL	AL	AL	AL
11	026.0067	PA	PA	PA	PA	PA